

INICIO

MÉDIA C

PROVA DE REGULARIDADE TRILHEIROS DO MORREBA
27/10/2018



IMPORTANTE

☠ CUIDADO

☠☠ ATENÇÃO

☠☠☠ MUITA ATENÇÃO

Tempo de Prova

MÉDIA C 03:18:50



AFERIÇÃO

DEVAGAR



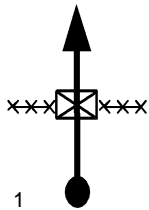

CRIANÇAS



0.00

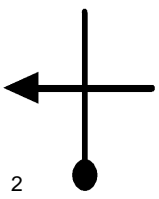

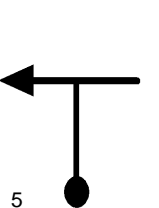



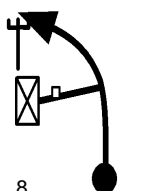
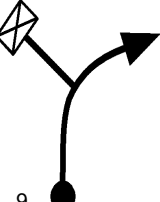
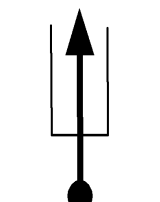

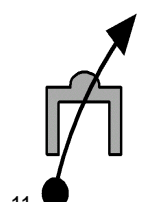
AFER

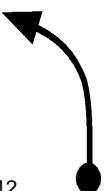

1

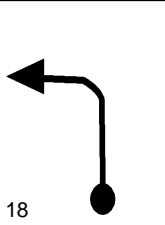
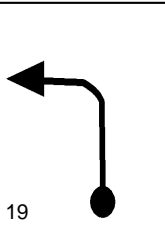
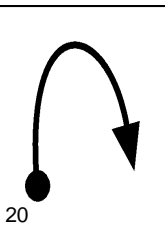
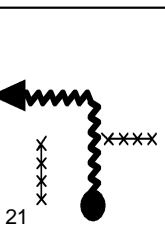
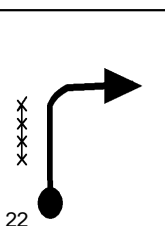
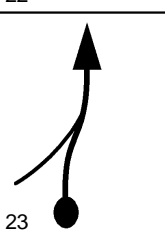

| | |
|------|---|
| 0.06 |  |
| AFER | 2 |
| 0.09 |  |
| AFER | 3 |
| 0.24 |  |
| AFER | 4 |
| 0.40 |  |
| AFER | 5 |
| 1.01 |  |
| AFER | 6 |
| 1.40 |  |
| AFER | 7 |

| | |
|---|---|
| 2.07 |  |
| AFER | 8 |
| 2.22 |  |
| AFER | 9 |
| AFERIR INICIO LAJOTA | |
| 2.45 |  |
| 0.00 | |
| AFER | 10 |
|  | |
| INICIO DE PROVA | |
| INICIO DA PROVA | |
| 0.00 |  |
| V 24 00.00.00 | |
| T1 | 11 |

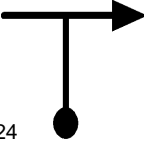
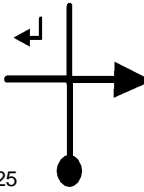

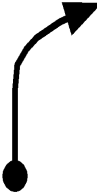
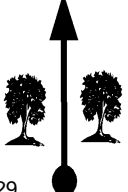

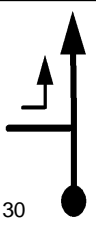
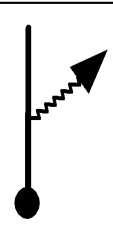
| | |
|--|---|
| 0.06 |  |
| V 24 00.00.09 | |
| T1 | 12 |
| 0.34 |  |
| V 24 00.00.51 | |
| T1 | 13 |
| 0.57 | xxxx xxxx  |
| V 24 00.01.26 | |
| T1 | 14 |
| 0.78 |  |
| V 21 00.01.57 | |
| T2 | 15 |
| 0.94 |  |
| V 21 00.02.24 | |
| T2 | 16 |
| 0.98 |  |
| V 21 00.02.31 | |
|  T2 | 17 |

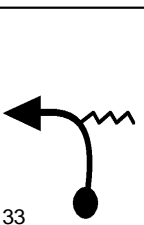
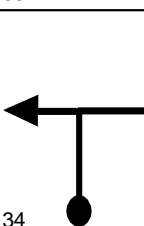
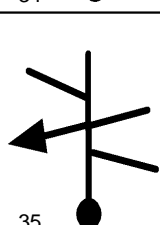
| | |
|---------------|---|
| 1.00 |  |
| V 21 00.02.35 | |
| T2 | 18 |
| 1.07 |  |
| V 21 00.02.47 | |
| T2 | 19 |
| 1.14 |  |
| V 21 00.02.59 | |
| T2 | 20 |
| 1.29 |  |
| V 9 00.03.24 | |
| T3 | 21 |
| 1.31 |  |
| V 24 00.03.32 | |
| T4 | 22 |
| 1.40 |  |
| V 24 00.03.46 | |
| T4 | 23 |

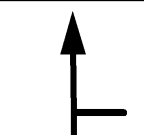
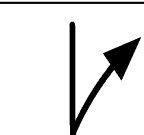
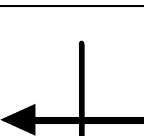
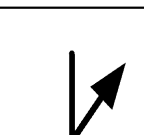
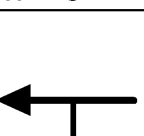
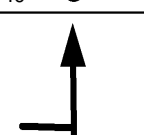
| | |
|---------------|---|
| 1.53 |  |
| V 24 00.04.05 | 24 |
| T4 | |
| 1.69 |  |
| V 24 00.04.29 | 25 |
| T4 | |
| 2.07 |  |
| V 24 00.05.26 | 26 |
| T4 | |
| 2.13 |  |
| V 24 00.05.35 | 27 |
| T4 | |
| 2.19 |  |
| V 24 00.05.44 | 28 |
| T4 | |
| 2.43 |  |
| V 24 00.06.20 | 29 |
| T4 | |

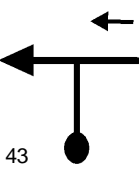
| | |
|---------------|---|
| 2.58 |  |
| V 24 00.06.43 | |
| T4 | 30 |
| 2.63 |  |
| V 24 00.06.50 | |
| T5 | 31 |
| 2.75 |  |
| V 24 00.07.08 | |
| T5 | 32 |
| 2.87 |  |
| V 24 00.07.26 | |
| T5 | 33 |
| 3.00 |  |
| V 30 00.07.46 | |
| T6 | 34 |
| 3.29 |  |
| V 24 00.08.21 | |
| T7 | 35 |

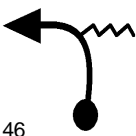
| | |
|---------------|---|
| 3.36 |  |
| V 24 00.08.31 | 36 |
| 3.40 |  |
| V 24 00.08.37 | 37 |
| 3.51 |  |
| V 24 00.08.54 | 38 |
| 3.53 |  |
| V 24 00.08.57 | 39 |
| 3.65 |  |
| V 24 00.09.15 | 40 |
| 3.67 |  |
| V 24 00.09.18 | 41 |

| | |
|-----------------|---|
| 3.70 |  |
| V 24 00.09.22 | 42 |
| T7 | |
| 3.73 |  |
| V 24 00.09.27 | 43 |
| T7 | |
| 3.78 |  |
| V 24 00.09.34 | 44 |
| T7 | |
| 3.90 |  |
| V 24 00.09.52 | 45 |
| T7 | |
| 4.01 |  |
| V 24 00.10.09 | 46 |
| T7 | |
| 4.15 |  |
| N2'30s 00.10.30 | 47 |
| T8 | |

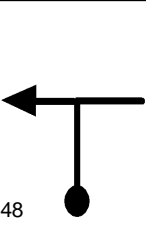
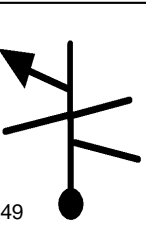
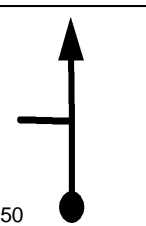
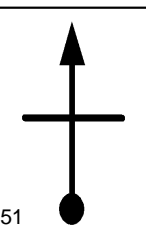
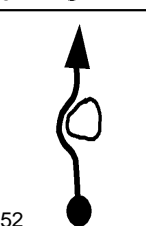
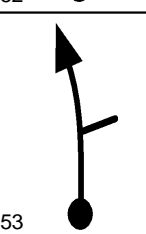
| | |
|---------------|---|
| 4.15 |  |
| V 30 00.13.00 | |
| T9 | 48 |
| 4.44 |  |
| V 21 00.13.35 | |
| T10 | 49 |
| 4.48 |  |
| V 21 00.13.41 | |
| T10 | 50 |
| 4.58 |  |
| V 21 00.13.59 | |
| T10 | 51 |
| 4.62 |  |
| V 21 00.14.05 | |
| T11 | 52 |
| 4.64 |  |
| V 21 00.14.09 | |
| T11 | 53 |

| | |
|---------------|---|
| 4.70 |  |
| V 21 00.14.19 | |
| T11 | 54 |

| | |
|---------------|---|
| 4.76 |  |
| V 21 00.14.29 | |
| T11 | 55 |

EROSAO

| | |
|---------------|---|
| 4.81 |  |
| V 15 00.14.38 | |
| T12 | 56 |

ACELERE PEDRA SABAO

| | |
|---------------|---|
| 4.85 |  |
| V 21 00.14.48 | |
| T13 | 57 |

| | |
|---------------|--|
| 4.98 |  |
| V 21 00.15.10 | |
| T13 | 58 |

| | |
|---------------|---|
| 5.25 |  |
| V 24 00.15.56 | |
| T14 | 59 |







| | |
|---------------|----|
| 5.42 | |
| V 24 00.16.22 | |
| T14 | 60 |

| | |
|---------------|----|
| 5.57 | |
| V 24 00.16.44 | |
| T14 | 61 |

| | |
|---------------|----|
| 5.64 | |
| V 24 00.16.55 | |
| T14 | 62 |

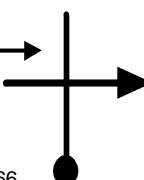





| | |
|---------------|----|
| 5.94 | |
| V 24 00.17.40 | |
| T14 | 63 |

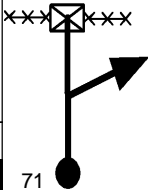

| | |
|---------------|----|
| 6.03 | |
| V 24 00.17.53 | |
| T14 | 64 |

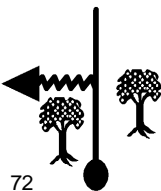
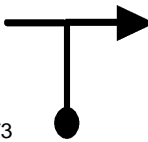
| | |
|----------------------|---|
| 6.09 |  |
| V 24 00.18.02 T14 | 65 |
| 6.22 |  |
| V 24 00.18.22 T14 | 66 |
| 6.32 |  |
| V 24 00.18.37 T14 | 67 |
| 6.38 |  |
| V 24 00.18.46 T14 | 68 |
| 6.42 |  |
| V 24 00.18.52 T14 | 69 |
| 6.44 |  |
| V 24 00.18.55 T14 | 70 |

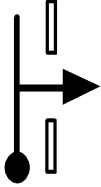
CUIDADO CERCA

A FRENTE

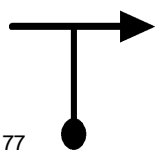
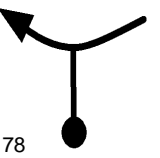
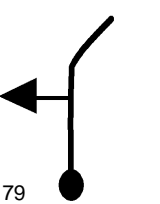
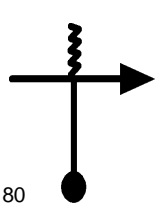
| | |
|--|---|
| 6.67 |  |
| V 18 00.19.29 | |
|  T15 | 71 |
| 6.71 |  |
| V 18 00.19.37 | |
| T15 | 72 |
| 6.72 |  |
| V 27 00.19.39 | |
| T16 | 73 |
| 7.05 |  |
| N 3' 00.20.23 | |
| T17 | 74 |
| 7.05 |  |
| V 24 00.23.23 | |
| T18 | 75 |
| 7.24 |  |
| V 24 00.23.52 | |
| T18 | 76 |

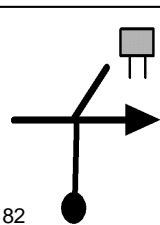
| | |
|---------------|---|
| 7.35 |  |
| V 24 00.24.08 | 77 |
| T18 | |
| 7.54 |  |
| V 24 00.24.37 | 78 |
| T18 | |
| 7.64 |  |
| V 24 00.24.52 | 79 |
| T18 | |
| 7.68 |  |
| V 24 00.24.58 | 80 |
| T18 | |
| 7.88 |  |
| 0.00 | |
| N 1' 00.25.28 | 81 |
| T19 | |
| 0.00 |  |
| V 27 00.26.28 | |
| T20 | |

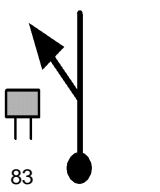
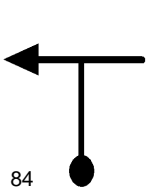
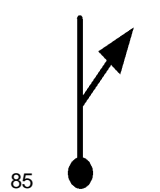
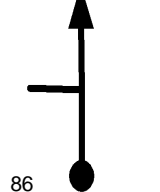
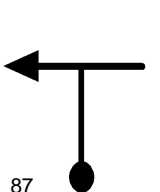
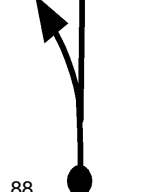
| | |
|---|---|
| <p>0.03</p> <p>V 27 00.26.32</p> <p>T20</p> |  <p>83</p> |
| <p>0.24</p> <p>V 27 00.27.00</p> <p>T20</p> |  <p>84</p> |
| <p>0.26</p> <p>V 27 00.27.02</p> <p>T20</p> |  <p>85</p> |
| <p>0.34</p> <p>V 27 00.27.13</p> <p>T20</p> |  <p>86</p> |
| <p>0.42</p> <p>V 27 00.27.24</p> <p>T20</p> |  <p>87</p> |
| <p>0.43</p> <p>V 27 00.27.25</p> <p>T20</p> |  <p>88</p> |

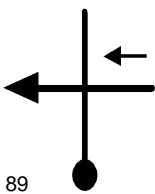
| | |
|---------------|--|
| 0.65 |  |
| V 27 00.27.54 | |
| T20 | 89 |

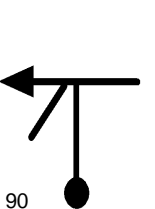
| | |
|---------------|---|
| 0.67 |  |
| V 27 00.27.57 | |
| T20 | 90 |

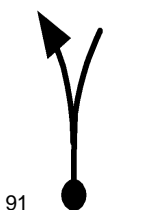

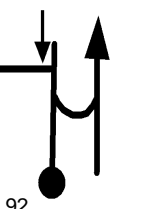

| | |
|---------------|---|
| 0.90 |  |
| V 27 00.28.28 | |
| T20 | 91 |

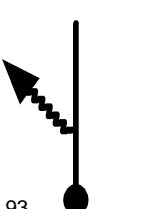

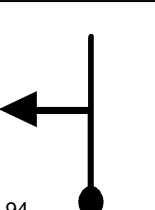

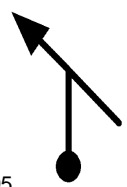
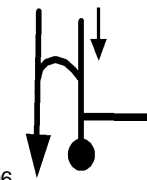
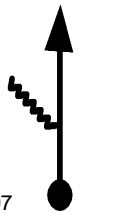
| | |
|---------------|---|
| 0.96 |  |
| V 27 00.28.36 | |
| T20 | 92 |

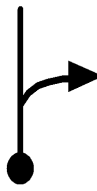

PINHEIRO

| | |
|---------------|--|
| 1.01 |  |
| V 27 00.28.42 | |
| T20 | 93 |

| | |
|---------------|---|
| 1.23 |  |
| V 27 00.29.12 | |
| T20 | 94 |

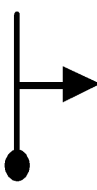
| | |
|---------------|---|
| 1.26 |  |
| V 27 00.29.16 | 95 |
| T20 | |
| 1.50 |  |
| V 27 00.29.48 | 96 |
| T20 | |
| 1.55 |  |
| V 30 00.29.54 | 97 |
| T21 | |
| 1.77 |  |
| V 30 00.30.21 | 98 |
| T21 | |
| 2.00 |  |
| V 30 00.30.48 | 99 |
| T21 | |
| 2.12 |  |
| V 21 00.31.03 | 100 |
| T22 | |

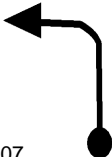
| | |
|---------------|---|
| 2.34 |  |
| V 27 00.31.40 | |
| T23 | 101 |
| 2.36 |  |
| V 27 00.31.43 | |
| T23 | 102 |
| 2.54 |  |
| V 27 00.32.07 | |
| T23 | 103 |
| 2.67 |  |
| V 27 00.32.24 | |
| T23 | 104 |
| 2.78 |  |
| V 27 00.32.39 | |
| T23 | 105 |
| 2.84 |  |
| V 27 00.32.47 | |
| T23 | 106 |

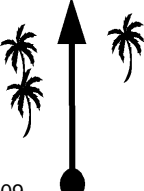
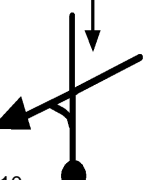
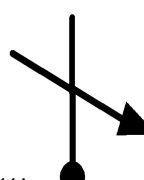
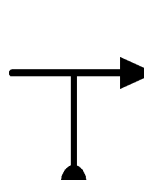
| | |
|-----------------|---|
| 2.90 |  |
| V 27 00.32.55 | |
| T23 | 107 |
| 3.00 |  |
| Nº'30s 00.33.08 | |
| T24 | 108 |
| 3.00 |  |
| V 21 00.35.38 | |
| T25 | 109 |
| 3.17 |  |
| V 15 00.36.08 | |
| T26 | 110 |
| 3.22 |  |
| V 24 00.36.20 | |
| T27 | 111 |
| 3.32 |  |
| V 24 00.36.35 | |
| T27 | 112 |

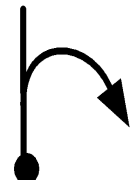
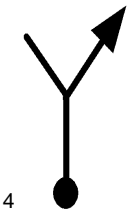
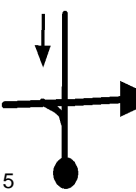
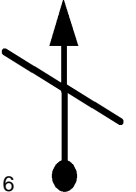
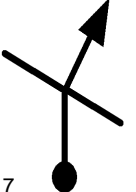
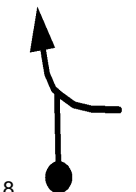
| | |
|----------------------|---|
| 3.37 |  |
| V 24 00.36.42 T27 | 113 |
| 3.44 |  |
| V 24 00.36.53 T27 | 114 |
| 3.51 |  |
| V 24 00.37.03 T27 | 115 |
| 3.56 |  |
| V 24 00.37.11 T27 | 116 |
| 3.93 |  |
| V 24 00.38.06 T27 | 117 |
| 3.96 |  |
| V 24 00.38.11 T27 | 118 |

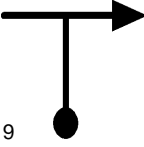
| | |
|---------------|--|
| 4.06 |  |
| V 24 00.38.26 | |
| T27 | 119 |

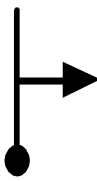

| | |
|---------------|---|
| 4.36 |  |
| V 24 00.39.11 | |
| T27 | 120 |

| | |
|---------------|---|
| 4.37 |  |
| V 24 00.39.12 | |
| T27 | 121 |

| | |
|---------------|--|
| 4.42 |  |
| V 24 00.39.20 | |
| T27 | 122 |

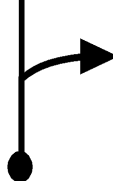
| | |
|---------------|---|
| 4.48 |  |
| V 24 00.39.29 | |
| T27 | 123 |

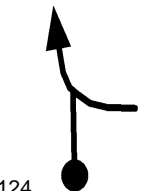
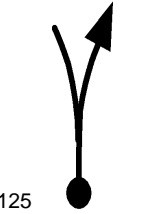
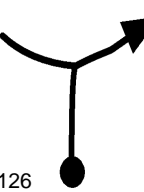
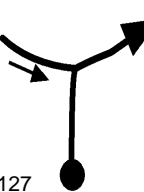
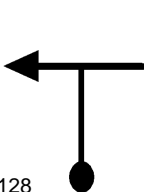
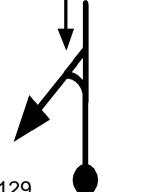
| | |
|---------------|---|
| 4.64 |  |
| V 24 00.39.53 | |
| T27 | 124 |
| 4.65 |  |
| V 24 00.39.54 | |
| T27 | 125 |
| 4.72 |  |
| V 24 00.40.05 | |
| T27 | 126 |
| 4.80 |  |
| V 24 00.40.17 | |
| T27 | 127 |
| 4.90 |  |
| V 33 00.40.32 | |
| T28 | 128 |
| 5.16 |  |
| V 33 00.41.00 | |
| T28 | 129 |

5.21

V 21 00.41.05

T29 130

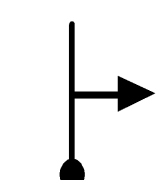

5.31

V 21 00.41.22

T29 131

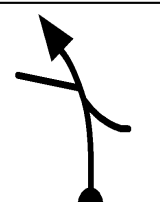

5.36

V 24 00.41.31

T30 132

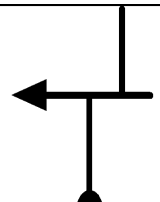

5.40

V 24 00.41.37

T31 133

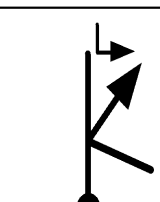

5.51

V 24 00.41.54

T31 134

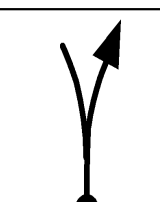

5.61

V 24 00.42.09

T31 135

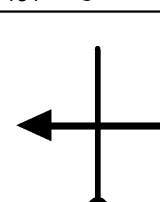

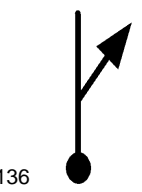
| | |
|---------------|--|
| 5.63 |  |
| V 24 00.42.12 | |
| T31 | 136 |

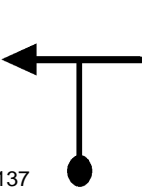
| | |
|---------------|---|
| 5.75 |  |
| V 24 00.42.30 | |
| T31 | 137 |

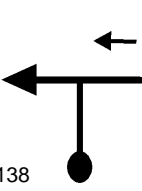

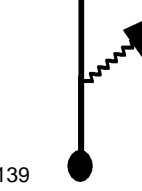
| | |
|---------------|---|
| 5.83 |  |
| V 24 00.42.42 | |
| T31 | 138 |

| | |
|---------------|---|
| 5.89 |  |
| V 24 00.42.51 | |
| T31 | 139 |

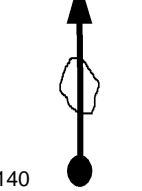

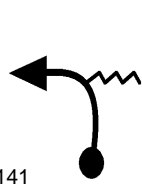

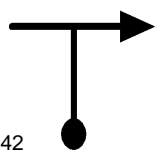
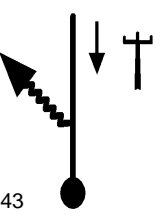

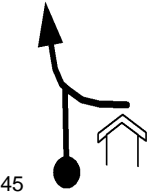
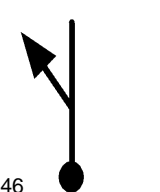
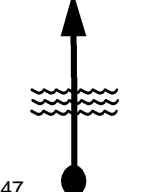
ATOLEIRO



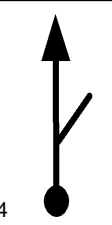

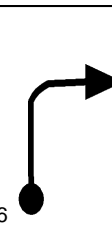

| | |
|---------------|--|
| 6.01 |  |
| V 24 00.43.09 | |
| T31 | 140 |

| | |
|---------------|---|
| 6.12 |  |
| V 24 00.43.25 | |
| T31 | 141 |

| | |
|---------------|---|
| 6.25 |  |
| V 30 00.43.45 | |
| T32 | 142 |
| 7.02 |  |
| V 21 00.45.17 | |
| T33 | 143 |
| 7.21 |  |
| N 2' 00.45.50 | |
| T34 | 144 |
| 7.21 |  |
| V 27 00.47.50 | |
| T35 | 145 |
| 7.28 |  |
| V 27 00.47.59 | |
| T35 | 146 |
| 7.97 |  |
| V 27 00.49.31 | |
| T35 | 147 |

| | |
|---------------|-----|
| 8.25 | |
| V 27 00.50.08 | |
| T35 | 148 |
| 8.34 | |
| V 27 00.50.20 | |
| T35 | 149 |
| 8.41 | |
| V 27 00.50.30 | |
| T35 | 150 |
| 8.51 | |
| V 27 00.50.43 | |
| T35 | 151 |
| GOIABEIRA | |
| 8.71 | |
| V 27 00.51.10 | |
| T35 | 152 |
| 8.97 | |
| V 27 00.51.44 | |
| T35 | 153 |

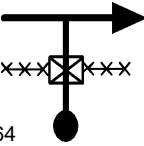
| | |
|---------------|---|
| 9.15 |  |
| V 27 00.52.08 | |
| T35 | 154 |
| 9.41 |  |
| V 27 00.52.43 | |
| T35 | 155 |
| 9.50 |  |
| V 27 00.52.55 | |
| T35 | 156 |
| 9.64 |  |
| V 27 00.53.14 | |
| T35 | 157 |
| 9.77 |  |
| V 27 00.53.31 | |
| T35 | 158 |
| 10.03 |  |
| V 27 00.54.06 | |
| T35 | 159 |

| | |
|-----------------|---|
| 10.09 |  |
| V 27 00.54.14 | |
| T35 | 160 |
| 10.37 |  |
| V 9 00.54.51 | |
| T36 | 161 |
| 10.41 |  |
| V 9 00.55.07 | |
| T36 | 162 |
| 10.50 |  |
| 0.00 | |
| N2'30s 00.55.43 | |
| T37 | 163 |
| 0.00 |  |
| V 30 00.58.13 | |
| T38 | 164 |
| 0.43 |  |
| V 21 00.59.04 | |
| T39 | 165 |

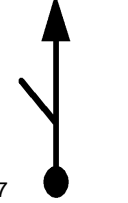
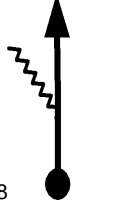
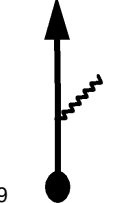
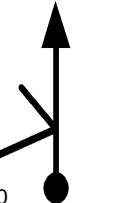
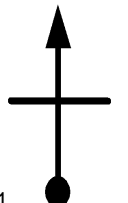
| | |
|---------------|---|
| 0.62 |  |
| V 27 00.59.37 | |
| T40 | 166 |
| 0.68 |  |
| V 27 00.59.45 | |
| T40 | 167 |
| 0.81 |  |
| V 27 01.00.02 | |
| T40 | 168 |
| 1.04 |  |
| V 27 01.00.33 | |
| T40 | 169 |
| 1.13 |  |
| V 27 01.00.45 | |
| T40 | 170 |
| 1.29 |  |
| V 27 01.01.06 | |
| T40 | 171 |

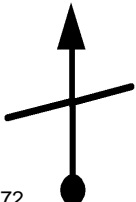
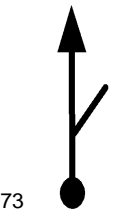
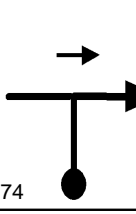
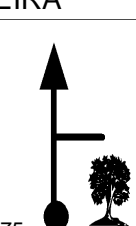
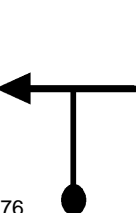
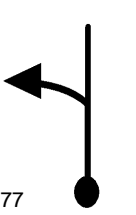
| | |
|---------------|---|
| 1.56 |  |
| V 27 01.01.42 | |
| T40 | 172 |
| 1.63 |  |
| V 27 01.01.52 | |
| T40 | 173 |
| 1.68 |  |
| V 30 01.01.58 | |
| T41 | 174 |
| GOIABEIRA | |
| 1.88 |  |
| V 30 01.02.22 | |
| T41 | 175 |
| 2.07 |  |
| V 30 01.02.45 | |
| T41 | 176 |
| 2.30 |  |
| V 30 01.03.13 | |
| T41 | 177 |

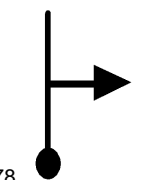
| | |
|---------------|--|
| 2.63 |  |
| V 27 01.03.52 | |
| T42 | 178 |

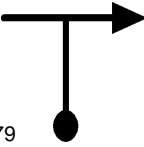

| | |
|---------------|---|
| 2.77 |  |
| V 27 01.04.11 | |
| T42 | 179 |

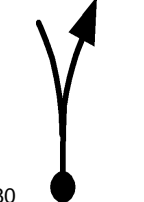

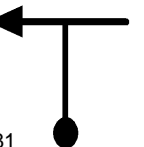
| | |
|---------------|---|
| 2.83 |  |
| V 27 01.04.19 | |
| T42 | 180 |

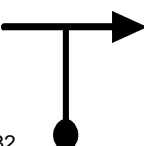
| | |
|---------------|---|
| 2.90 |  |
| V 27 01.04.28 | |
| T42 | 181 |

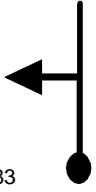
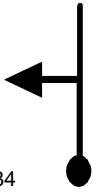
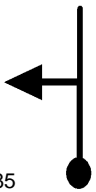
| | |
|---------------|---|
| 3.03 |  |
| V 27 01.04.46 | |
| T42 | 182 |

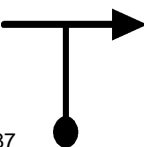
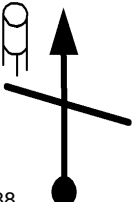
| | |
|-------------------------|---|
| 3.05 |  |
| V 27 01.04.48 | |
| T42 | 183 |
| 3.14 |  |
| V 27 01.05.00 | |
| T42 | 184 |
| 3.63 |  |
| V 27 01.06.06 | |
| T42 | 185 |
| 4.00 |  |
| Nº'30s 01.06.55 | |
| T43 | 186 |
| 4.00 |  |
| V 30 01.09.25 | |
| T44 | 187 |
| CAIXA D'AGUA A ESQUERDA | |
| 4.29 |  |
| V 30 01.10.00 | |
| T44 | 188 |

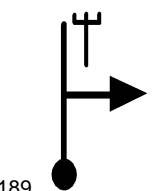
| | |
|---------------|--|
| 4.55 |  |
| V 30 01.10.31 | |
| T45 | 189 |

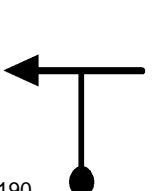
| | |
|---------------|---|
| 4.81 |  |
| V 30 01.11.02 | |
| T45 | 190 |

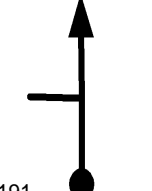
| | |
|---------------|---|
| 4.86 |  |
| V 30 01.11.08 | |
| T45 | 191 |

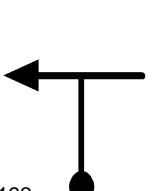
| | |
|---------------|---|
| 4.89 |  |
| V 30 01.11.12 | |
| T45 | 192 |

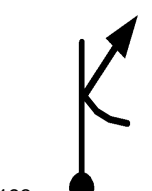
| | |
|---------------|--|
| 5.01 |  |
| V 30 01.11.26 | |
| T45 | 193 |

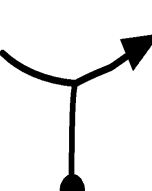

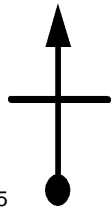
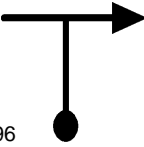
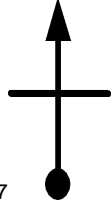
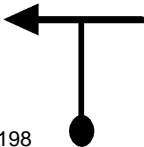
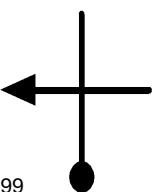
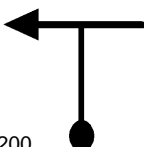

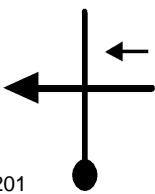
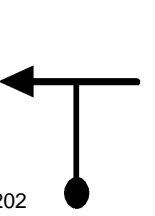
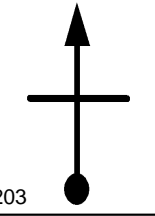
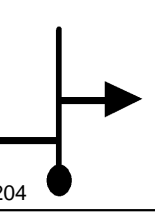
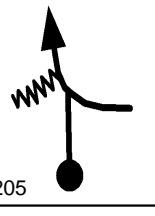
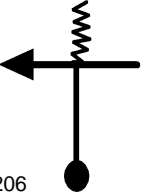
| | |
|---------------|---|
| 5.12 |  |
| V 21 01.11.39 | |
| T46 | 194 |

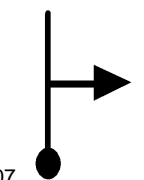
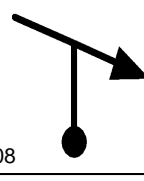
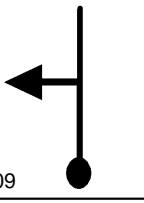
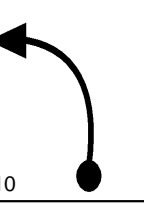
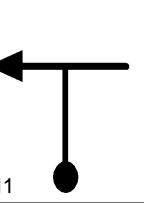
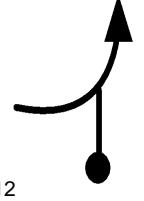
| | |
|---------------|---|
| 5.14 |  |
| V 21 01.11.43 | |
| T46 | 195 |
| 5.15 |  |
| V 21 01.11.45 | |
| T46 | 196 |
| 5.17 |  |
| V 21 01.11.48 | |
| T46 | 197 |
| 5.27 |  |
| V 21 01.12.05 | |
| T46 | 198 |
| 5.31 |  |
| V 21 01.12.12 | |
| T46 | 199 |
| 5.41 |  |
| V 21 01.12.29 | |
| T46 | 200 |

| | |
|---------------|---|
| 5.44 |  |
| V 21 01.12.34 | |
| T46 | 201 |
| 5.54 |  |
| V 21 01.12.51 | |
| T46 | 202 |
| 5.57 |  |
| V 21 01.12.57 | |
| T46 | 203 |
| 5.61 |  |
| V 21 01.13.03 | |
| T46 | 204 |
| 5.80 |  |
| V 24 01.13.36 | |
| T47 | 205 |
| 5.92 |  |
| V 24 01.13.54 | |
| T47 | 206 |

| | |
|---------------|---|
| 5.99 |  |
| V 24 01.14.04 | |
| T47 | 207 |
| 6.16 |  |
| V 24 01.14.30 | |
| T47 | 208 |
| 6.25 |  |
| V 24 01.14.43 | |
| T47 | 209 |
| 6.30 |  |
| V 30 01.14.51 | |
| T48 | 210 |
| 6.59 |  |
| V 30 01.15.26 | |
| T48 | 211 |
| 6.66 |  |
| V 30 01.15.34 | |
| T48 | 212 |

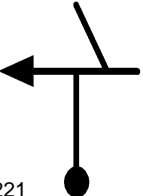
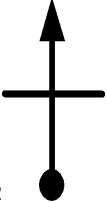
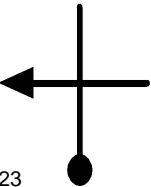
| | |
|---------------|-----|
| 7.07 | |
| V 30 01.16.23 | |
| T48 | 213 |
| IGREJA | |
| 7.69 | |
| N 2' 01.17.38 | |
| T49 | 214 |
| 7.69 | |
| V 33 01.19.38 | |
| T50 | 215 |
| 7.97 | |
| V 30 01.20.08 | |
| T51 | 216 |
| 8.44 | |
| V 33 01.21.05 | |
| T52 | 217 |
| 8.55 | |
| V 33 01.21.17 | |
| T52 | 218 |

| | |
|---------------|---|
| 8.56 |  |
| V 33 01.21.18 | |
| T52 | 219 |
| 8.66 |  |
| V 33 01.21.29 | |
| T52 | 220 |
| 8.88 |  |
| V 24 01.21.53 | |
| T53 | 221 |
| 8.91 |  |
| V 24 01.21.57 | |
| T53 | 222 |
| 8.94 |  |
| V 24 01.22.02 | |
| T53 | 223 |
| 9.14 |  |
| V 24 01.22.32 | |
| T53 | 224 |

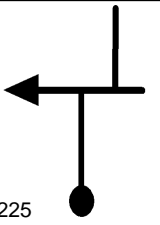
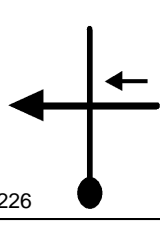
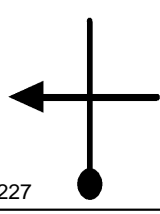
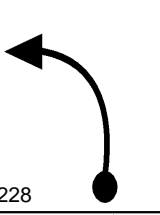
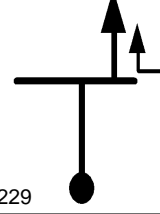
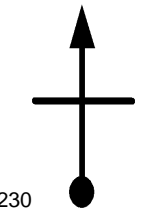
| | |
|---------------|---|
| 9.16 |  |
| V 24 01.22.35 | |
| T53 | 225 |
| 9.36 |  |
| V 24 01.23.05 | |
| T53 | 226 |
| 9.38 |  |
| V 24 01.23.08 | |
| T53 | 227 |
| 9.59 |  |
| V 24 01.23.39 | |
| T53 | 228 |
| 9.61 |  |
| V 27 01.23.42 | |
| T54 | 229 |
| 9.84 |  |
| V 27 01.24.13 | |
| T54 | 230 |

9.96
V 27 01.24.29
T54 231

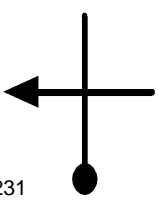

9.99
V 27 01.24.33
T54 232

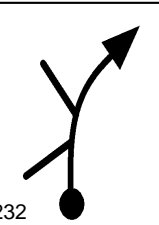

10.09
V 27 01.24.46
T54 233

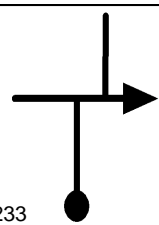

10.19
V 27 01.25.00
T54 234

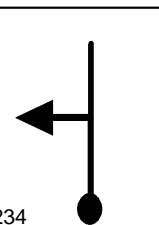

10.32
0.00
N1'30s 01.25.17
T55 235



0.00
V 24 01.26.47
T56 236

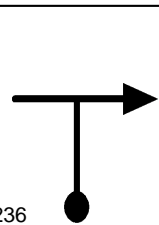

| | |
|---------------|-----|
| 0.13 | |
| V 24 01.27.06 | |
| T56 | 237 |

| | |
|---------------|-----|
| 0.22 | |
| V 24 01.27.20 | |
| T56 | 238 |







| | |
|---------------|-----|
| 0.41 | |
| V 24 01.27.48 | |
| T56 | 239 |

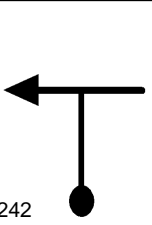
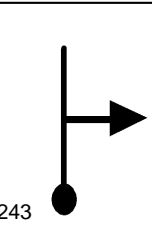
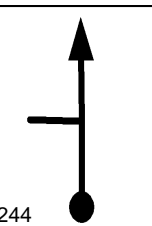
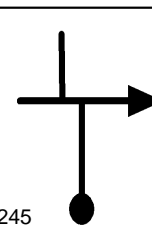
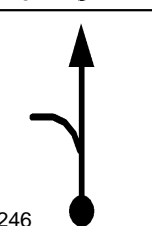
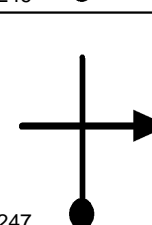

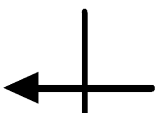



| | |
|---------------|-----|
| 0.43 | |
| V 24 01.27.51 | |
| T56 | 240 |

| | |
|---------------|-----|
| 0.57 | |
| V 24 01.28.12 | |
| T56 | 241 |

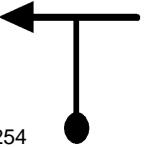
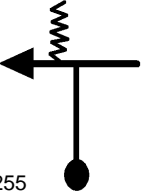
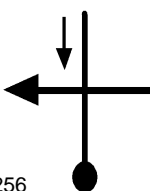
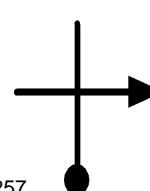
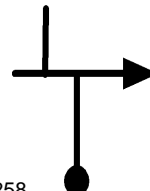
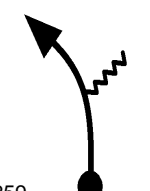
| | |
|---------------|---|
| 0.60 |  |
| V 24 01.28.17 | |
| T56 | 242 |
| 0.70 |  |
| V 24 01.28.32 | |
| T56 | 243 |
| 0.77 |  |
| V 24 01.28.42 | |
| T56 | 244 |
| 0.81 |  |
| V 24 01.28.48 | |
| T56 | 245 |
| 0.82 |  |
| V 24 01.28.50 | |
| T56 | 246 |
| 0.91 |  |
| V 24 01.29.03 | |
| T56 | 247 |

| | |
|---------------|---|
| 0.97 |  |
| V 24 01.29.12 | 248 |
| T56 | |
| 1.07 |  |
| V 24 01.29.27 | 249 |
| T56 | |
| 1.14 |  |
| V 24 01.29.38 | 250 |
| T56 | |
| 1.18 |  |
| V 24 01.29.44 | 251 |
| T56 | |
| 1.20 |  |
| V 24 01.29.47 | 252 |
| T56 | |
| 1.23 |  |
| V 24 01.29.51 | 253 |
| T56 | |

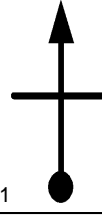
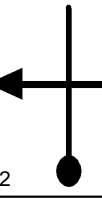
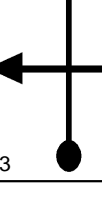
| | |
|---------------|---|
| 1.27 |  |
| V 24 01.29.57 | 254 |
| T56 | |
| 1.32 |  |
| V 24 01.30.05 | 255 |
| T56 | |
| 1.35 |  |
| V 24 01.30.09 | 256 |
| T56 | |
| 1.41 |  |
| V 24 01.30.18 | 257 |
| T56 | |
| 1.52 |  |
| V 24 01.30.35 | 258 |
| T56 | |
| 1.79 |  |
| V 24 01.31.15 | 259 |
| T56 | |

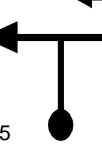
| | |
|---------------|---|
| 2.14 |  |
| V 27 01.32.08 | |
| T57 | 260 |
| 2.20 |  |
| V 27 01.32.16 | |
| T57 | 261 |
| 2.60 |  |
| V 27 01.33.09 | |
| T57 | 262 |
| 2.64 |  |
| V 27 01.33.15 | |
| T57 | 263 |
| 3.02 |  |
| V 27 01.34.05 | |
| T57 | 264 |
| 3.05 |  |
| V 27 01.34.09 | |
| T57 | 265 |

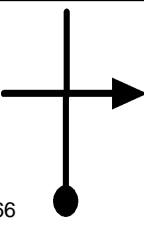
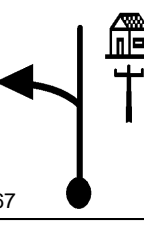
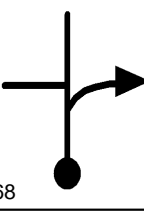
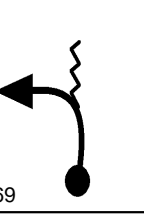
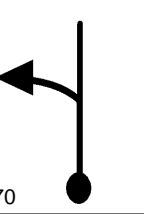
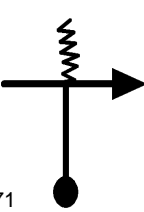
| | |
|---------------|---|
| 3.43 |  |
| V 27 01.35.00 | |
| T57 | 266 |
| 3.65 |  |
| V 24 01.35.29 | |
| T58 | 267 |
| 3.83 |  |
| V 27 01.35.56 | |
| T59 | 268 |
| 3.92 |  |
| V 27 01.36.08 | |
| T59 | 269 |
| 4.25 |  |
| V 27 01.36.52 | |
| T59 | 270 |
| 4.35 |  |
| V 27 01.37.06 | |
| T59 | 271 |

4.91
D1'30s 01.38.20
T60 272

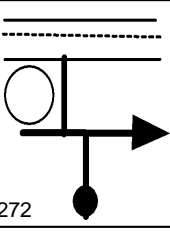

5.24
D1'30s
T60 273

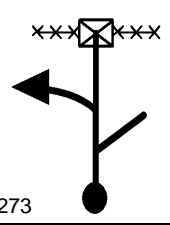

5.29
D1'30s
T60 274

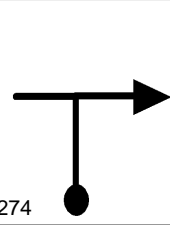

5.31
D1'30s
T60 275

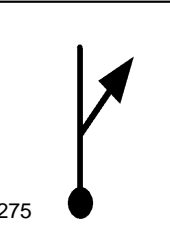

APOIO 2° ETAPA
5.31
0.00
N 15' 01.39.50
T61 276



0.00
D1'30s 01.54.50
T62 277

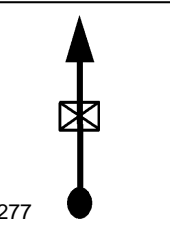

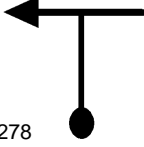
| | |
|-------------|--|
| 0.01 |  |
| D1'30s | |
| T62 | 278 |

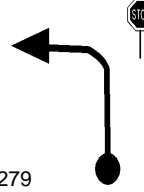
| | |
|-------------|---|
| 0.08 |  |
| D1'30s | |
| T62 | 279 |

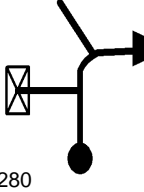
| | |
|-------------|---|
| 0.12 |  |
| D1'30s | |
| T62 | 280 |

RODOVIA



LUIZ ROSSO

| | |
|-------------|---|
| 0.46 |  |
| D1'30s | |
| T62 | 281 |

| | |
|-------------|---|
| 0.60 |  |
| D1'30s | |
| T62 | 282 |

| | |
|-------------|---|
| 1.05 |  |
| D1'30s | |
| T62 | 283 |

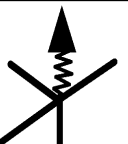
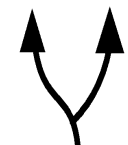
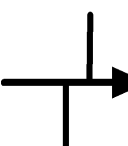
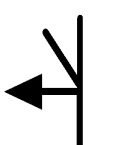
| | |
|----------------|--|
| 1.18 | |
| V 51 01.56.20 | |
| T63 284 | |
| OLARIA | |
| 2.03 | |
| V 51 01.57.20 | |
| T63 285 | |
| 3.16 | |
| V 51 01.58.40 | |
| T63 286 | |
| 4.11 | |
| V 21 01.59.47 | |
| T64 287 | |
| VIADUTO | |
| 4.29 | |
| V 21 02.00.18 | |
| T64 288 | |
| 4.36 | |
| V 15 02.00.30 | |
| T65 289 | |

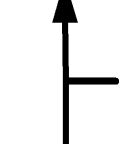
| | |
|---------------|---|
| 4.38 |  |
| V 15 02.00.35 | |
| T65 | 290 |
| 4.61 |  |
| V 15 02.01.30 | |
| T65 | 291 |
| 4.79 |  |
| V 24 02.02.13 | |
| T66 | 292 |
| 4.96 |  |
| V 33 02.02.39 | |
| T67 | 293 |
| CUIDADO ROÇA | |
| DONO BRABO | |
| 5.11 |  |
| V 33 02.02.55 | |
| T67 | 294 |
| 5.22 |  |
| V 33 02.03.07 | |
| T67 | 295 |

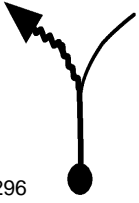
| | |
|---------------|--|
| 5.93 |  |
| V 15 02.04.24 | |
| T68 | 296 |

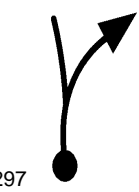
| | |
|---------------|---|
| 5.99 |  |
| V 15 02.04.39 | |
| T68 | 297 |

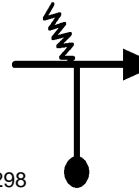
| | |
|---------------|---|
| 6.04 |  |
| V 15 02.04.51 | |
| T68 | 298 |

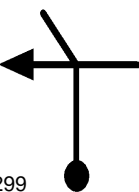
| | |
|---------------|---|
| 6.09 |  |
| V 27 02.05.03 | |
| T69 | 299 |

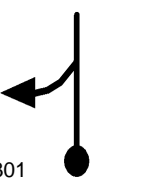
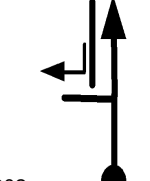
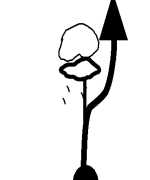
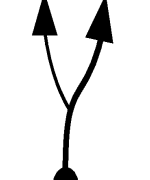
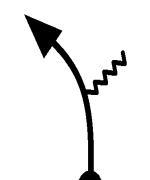
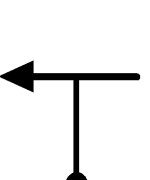

| | |
|-----------------|---|
| 6.22 |  |
| N1'30s 02.05.20 | |
| T70 | 300 |

| | |
|---------------|---|
| 6.22 |  |
| V 15 02.06.50 | T71 301 |
| BAMP | |
| 6.56 |  |
| V 15 02.08.12 | T71 302 |
| 6.68 |  |
| V 15 02.08.41 | T71 303 |
| 7.17 |  |
| V 12 02.10.38 | T72 304 |
| 7.21 |  |
| V 15 02.10.50 | T73 305 |
| 7.24 |  |
| V 15 02.10.57 | T73 306 |

CUIDADO

7.27

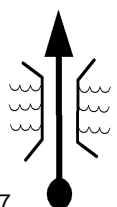

V 15 02.11.05

T73

307

7.40



V 18 02.11.36

T74

308

7.55



V 27 02.12.06

T75

309

7.60



V 27 02.12.12

T75

310

SIGA PELA DIREITA

7.84

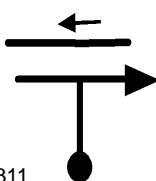

V 27 02.12.44

T75

311

7.95

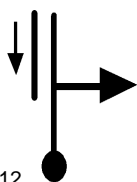



V 27 02.12.59

T75

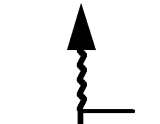
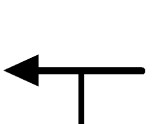
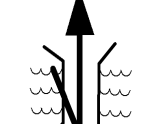
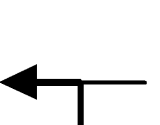
312

| | |
|--------------|---|
| 8.08 |  |
| V 9 02.13.16 | 313 |
| T76 | |
| 8.15 |  |
| V 9 02.13.44 | 314 |
| T76 | |
| 8.18 |  |
| V 9 02.13.56 | 315 |
| T76 | |
| 8.19 |  |
| V 9 02.14.00 | 316 |
| T76 | |

ACELERE

| | |
|---------------|---|
| 8.28 |  |
| V 9 02.14.36 | 317 |
| T76 | |
| 8.60 |  |
| V 12 02.16.44 | 318 |
| T77 | |

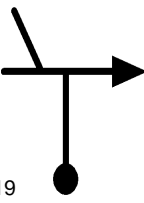
| | |
|---------------|--|
| 8.65 |  |
| V 12 02.16.59 | |
| T77 | 319 |

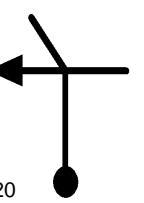
| | |
|---------------|---|
| 8.69 |  |
| V 27 02.17.11 | |
| T78 | 320 |



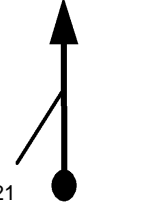



TRILHA DO TONINHO
QUEBRA CLAVICULA

| | |
|---------------|---|
| 8.83 |  |
| V 27 02.17.30 | |
| T78 | 321 |

| | |
|---------------|---|
| 9.12 |  |
| V 27 02.18.09 | |
| T78 | 322 |

| | |
|---------------|---|
| 9.14 |  |
| V 27 02.18.11 | |
| T78 | 323 |

| | |
|---------------|---|
| 9.16 |  |
| V 27 02.18.14 | |
| T78 | 324 |

| | |
|-----------------|---|
| 9.45 |  |
| 0.00 | |
| N2'30s 02.18.53 | |
| T79 | 325 |
| 0.00 |  |
| V 15 02.21.23 | |
| T80 | 326 |
| 0.05 |  |
| V 15 02.21.35 | |
| T81 | 327 |
| 0.07 |  |
| V 15 02.21.40 | |
| T81 | 328 |
| 0.12 |  |
| V 15 02.21.52 | |
| T81 | 329 |
| 0.15 |  |
| V 15 02.21.59 | |
| T81 | 330 |

SUBIDA CUIDADO

COQUEIRO APÓS SUBIDA

0.24

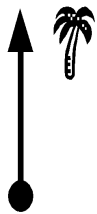

V 15 02.22.20

T81 331

ATENÇÃO

CORRIGIR ODOMETRO

0.32

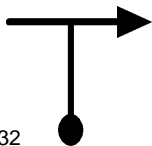

V 24 02.22.40

T82 332

0.51



V 24 02.23.08

T82 333

0.56

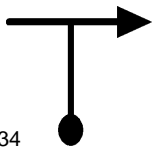

V 24 02.23.16









T82 334

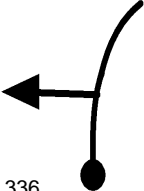
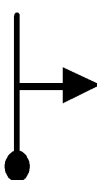

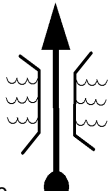
0.86

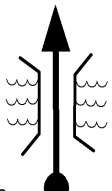



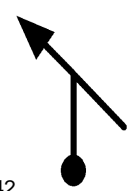
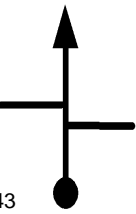
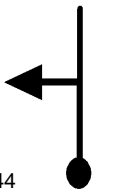
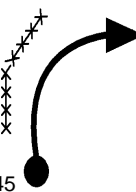

V 24 02.24.00

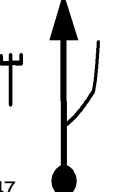
T82 335

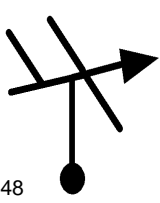
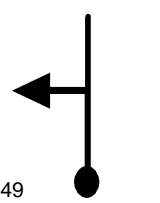
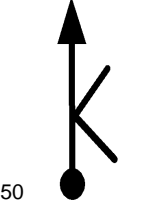
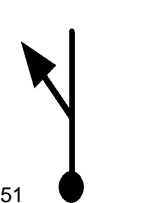
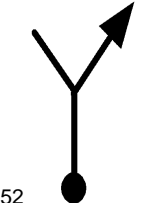
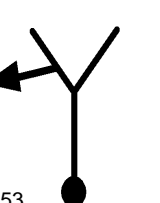
| | |
|--|---|
| 1.21 |  |
| V 21 02.24.53 | |
| T83 | 336 |
| 1.25 |  |
| V 21 02.25.00 | |
| T83 | 337 |
| 1.26 |  |
| V 9 02.25.02 | |
| T84 | 338 |
| 1.34 |  |
| V 12 02.25.34 | |
|  T85 | 339 |
| 1.54 |  |
| V 12 02.26.34 | |
|  T85 | 340 |
| 1.73 |  |
| V 12 02.27.31 | |
|  T85 | 341 |

| | |
|---------------|---|
| 1.79 |  |
| V 27 02.27.49 | |
| T86 | 342 |
| 1.81 |  |
| V 27 02.27.51 | |
| T86 | 343 |
| 2.15 |  |
| V 24 02.28.37 | |
| T87 | 344 |
| 2.21 |  |
| V 24 02.28.46 | |
| T87 | 345 |
| 2.27 |  |
| V 24 02.28.55 | |
| T87 | 346 |
| 2.33 |  |
| V 24 02.29.04 | |
| T87 | 347 |

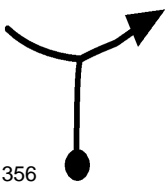
| | |
|---------------|---|
| 2.51 |  |
| V 24 02.29.31 | |
| T87 | 348 |
| 2.82 |  |
| V 27 02.30.17 | |
| T88 | 349 |
| 3.20 |  |
| V 27 02.31.08 | |
| T88 | 350 |
| 3.29 |  |
| V 24 02.31.20 | |
| T89 | 351 |
| 3.35 |  |
| V 24 02.31.29 | |
| T89 | 352 |
| 3.47 |  |
| V 24 02.31.47 | |
| T89 | 353 |

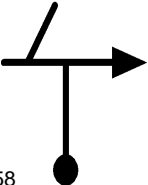
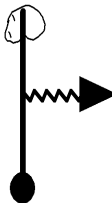
| | |
|---------------|---|
| 3.52 |  |
| V 24 02.31.54 | |
| T89 | 354 |
| 3.60 |  |
| V 24 02.32.06 | |
| T89 | 355 |
| 3.66 |  |
| V 24 02.32.15 | |
| T89 | 356 |
| 3.91 |  |
| N 2' 02.32.53 | |
| T90 | 357 |
| 3.91 |  |
| V 24 02.34.53 | |
| T91 | 358 |
| ATOLEIRO | |
| 3.95 |  |
| V 12 02.34.59 | |
| T92 | 359 |





| | |
|---------------|-----|
| 4.12 | |
| V 21 02.35.50 | |
| T93 | 360 |



| | |
|---------------|-----|
| 4.29 | |
| V 21 02.36.19 | |
| T93 | 361 |

| | |
|---------------|-----|
| 4.32 | |
| V 21 02.36.24 | |
| T93 | 362 |

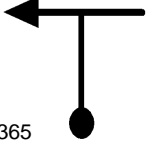
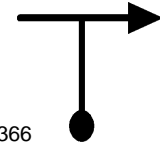
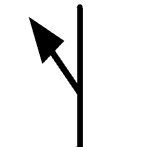
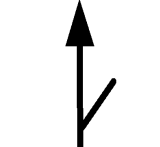
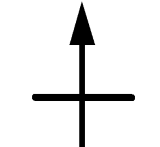

| | |
|---------------|-----|
| 4.34 | |
| V 21 02.36.27 | |
| T93 | 363 |

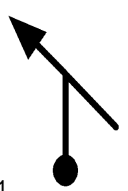
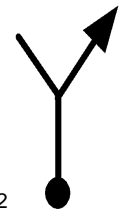
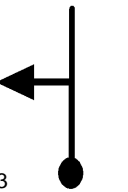
| | |
|---------------|-----|
| 4.35 | |
| V 21 02.36.29 | |
| T93 | 364 |

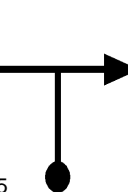
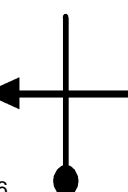
| | |
|---------------|---|
| 4.48 |  |
| V 21 02.36.51 | 365 |
| T93 | |
| 4.49 |  |
| V 27 02.36.53 | 366 |
| T94 | |
| 4.56 |  |
| V 27 02.37.02 | 367 |
| T94 | |
| 4.58 |  |
| V 27 02.37.05 | 368 |
| T94 | |
| 4.72 |  |
| V 27 02.37.24 | 369 |
| T94 | |
| 4.91 |  |
| V 27 02.37.49 | 370 |
| T94 | |

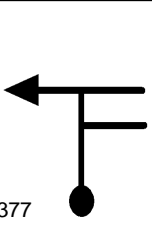
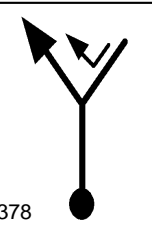
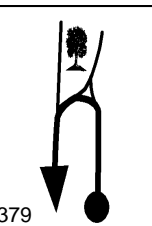
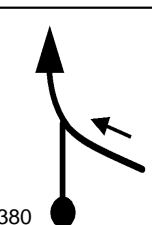
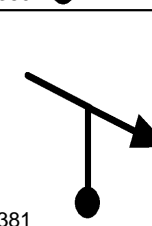
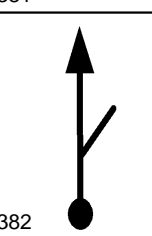
| | |
|---------------|---|
| 4.99 |  |
| V 27 02.38.00 | |
| T94 | 371 |
| 5.02 |  |
| V 27 02.38.04 | |
| T94 | 372 |
| 5.05 |  |
| V 27 02.38.08 | |
| T94 | 373 |
| 5.09 |  |
| V 27 02.38.13 | |
| T94 | 374 |
| 5.17 |  |
| V 27 02.38.24 | |
| T94 | 375 |
| 5.28 |  |
| V 27 02.38.38 | |
| T94 | 376 |

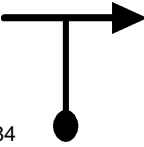
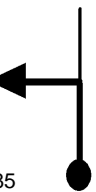
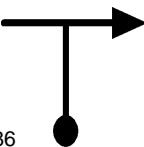
| | |
|---------------|---|
| 5.29 |  |
| V 27 02.38.40 | |
| T94 | 377 |
| 5.34 |  |
| V 27 02.38.46 | |
| T94 | 378 |
| 5.59 |  |
| V 27 02.39.20 | |
| T94 | 379 |
| 5.68 |  |
| V 24 02.39.32 | |
| T95 | 380 |
| 5.76 |  |
| V 24 02.39.44 | |
| T95 | 381 |
| 5.95 |  |
| V 24 02.40.12 | |
| T95 | 382 |

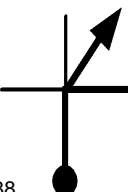
| | |
|---------------|---|
| 6.00 |  |
| V 24 02.40.20 | |
| T95 | 383 |
| 6.32 |  |
| V 24 02.41.08 | |
| T95 | 384 |
| 6.34 |  |
| V 24 02.41.11 | |
| T95 | 385 |
| 6.52 |  |
| V 24 02.41.38 | |
| T95 | 386 |
| 6.68 |  |
| V 24 02.42.02 | |
| T95 | 387 |
| 6.78 |  |
| V 24 02.42.17 | |
| T95 | 388 |

| | |
|---------------|---|
| 6.88 |  |
| V 24 02.42.32 | |
| T95 | 389 |

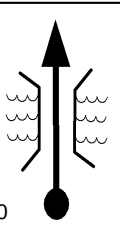
| | |
|---------------|---|
| 7.20 |  |
| V 24 02.43.20 | |
| T95 | 390 |



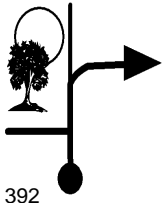

| | |
|-----------------|---|
| 7.28 |  |
| N1'30s 02.43.32 | |
| T96 | 391 |

CAIXA D'ÁGUA A ESQUERDA

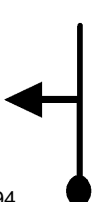
| | |
|---------------|---|
| 7.28 |  |
| V 27 02.45.02 | |
| T97 | 392 |

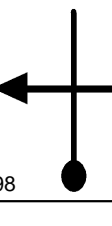

| | |
|---------------|--|
| 7.52 |  |
| V 27 02.45.34 | |
| T97 | 393 |

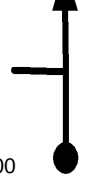
| | |
|---------------|---|
| 7.67 |  |
| V 21 02.45.54 | |
| T98 | 394 |

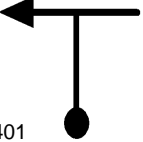
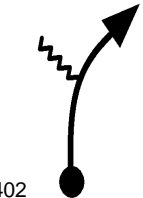
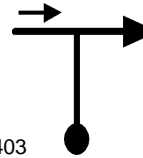
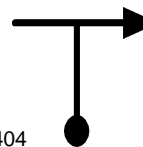
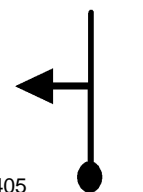
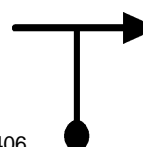
| | |
|---------------|---|
| 7.74 |  |
| V 21 02.46.06 | |
| T98 | 395 |
| 7.76 |  |
| V 21 02.46.09 | |
| T98 | 396 |
| 7.78 |  |
| V 21 02.46.13 | |
| T98 | 397 |
| 7.83 |  |
| V 21 02.46.21 | |
| T98 | 398 |
| 7.93 |  |
| V 27 02.46.38 | |
| T99 | 399 |
| 7.99 |  |
| V 27 02.46.46 | |
| T99 | 400 |

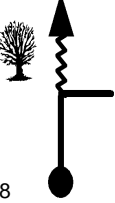
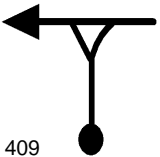
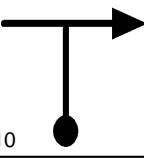
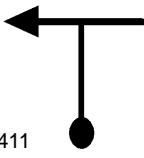
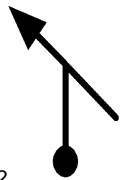
| | |
|---------------|---|
| 8.25 |  |
| V 30 02.47.21 | |
| T100 | 401 |
| 8.39 |  |
| V 30 02.47.38 | |
| T100 | 402 |
| 8.68 |  |
| V 30 02.48.13 | |
| T100 | 403 |
| 8.76 |  |
| V 30 02.48.22 | |
| T100 | 404 |
| 8.77 |  |
| V 30 02.48.23 | |
| T100 | 405 |
| 8.95 |  |
| V 30 02.48.45 | |
| T100 | 406 |

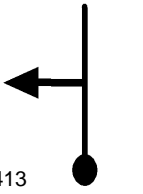
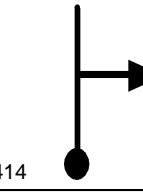
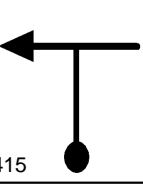
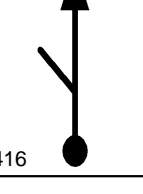
| | |
|---------------|---|
| 9.11 |  |
| V 24 02.49.04 | |
| T101 | 407 |
| LARANGEIRA | |
| 9.37 |  |
| V 12 02.49.43 | |
| T102 | 408 |
| 9.40 |  |
| V 12 02.49.52 | |
| T102 | 409 |
| 9.47 |  |
| V 18 02.50.13 | |
| T103 | 410 |
| 9.53 |  |
| V 18 02.50.25 | |
| T103 | 411 |
| 9.84 |  |
| V 27 02.51.27 | |
| T104 | 412 |

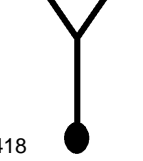
| | |
|---------------|---|
| 10.16 |  |
| V 27 02.52.10 | |
| T104 | 413 |
| 10.32 |  |
| V 27 02.52.31 | |
| T104 | 414 |
| 10.48 |  |
| V 27 02.52.53 | |
| T104 | 415 |
| 10.52 |  |
| V 27 02.52.58 | |
| T104 | 416 |
| 10.56 |  |
| N 1' 02.53.03 | |
| T105 | 417 |
| 10.56 |  |
| V 21 02.54.03 | |
| T106 | 418 |

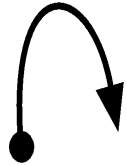
| | |
|---------------|--|
| 10.76 |  |
| V 21 02.54.38 | |
| T106 | 419 |



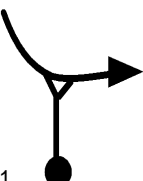

| | |
|---------------|---|
| 10.95 |  |
| V 21 02.55.10 | |
| T106 | 420 |



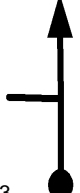

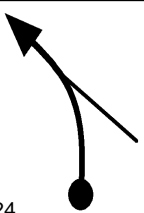
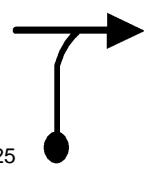
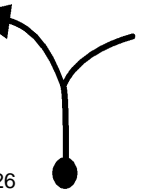
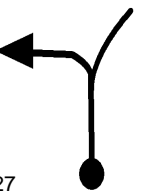
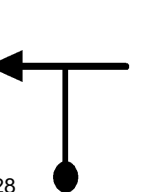
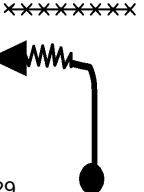

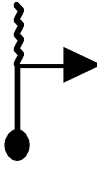
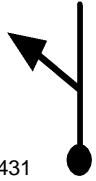
| | |
|---------------|---|
| 10.99 |  |
| V 30 02.55.17 | |
| T107 | 421 |

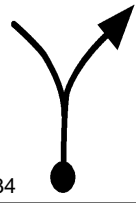
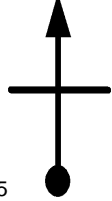

| | |
|---------------|--|
| 11.17 |  |
| V 30 02.55.39 | |
| T107 | 422 |



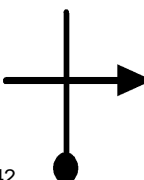

| | |
|---------------|---|
| 11.29 |  |
| V 30 02.55.53 | |
| T107 | 423 |

| | |
|---------------|--|
| 11.39 |  |
| V 30 02.56.05 | |
| T107 | 424 |
| 11.54 |  |
| V 33 02.56.23 | |
| T108 | 425 |
| 11.70 |  |
| V 33 02.56.40 | |
| T108 | 426 |
| 11.91 |  |
| V 33 02.57.03 | |
| T108 | 427 |
| 11.95 |  |
| V 33 02.57.08 | |
| T108 | 428 |
| 12.33 | <p>xxxxxxxxx</p>  |
| V 18 02.57.49 | |
| T109 | 429 |

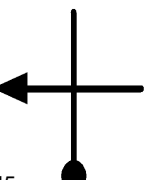
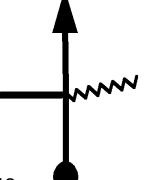
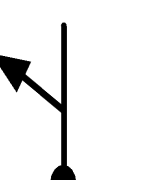

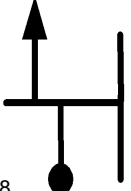
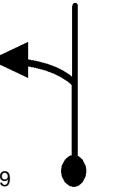
| | |
|---------------|---|
| 12.48 |  |
| V 18 02.58.19 | |
| T109 | 430 |
| 12.51 |  |
| V 18 02.58.25 | |
| T109 | 431 |
| 12.59 |  |
| V 24 02.58.41 | |
| T110 | 432 |
| 12.83 |  |
| V 24 02.59.17 | |
| T110 | 433 |
| 13.12 |  |
| V 24 03.00.01 | |
| T110 | 434 |
| 13.14 |  |
| V 24 03.00.04 | |
| T110 | 435 |

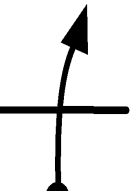
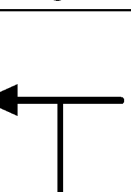

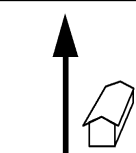
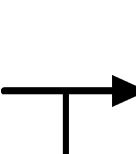
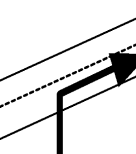
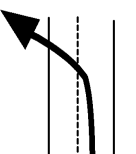
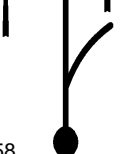

| | |
|---------------|---|
| 13.21 |  |
| V 24 03.00.14 | |
| T110 | 436 |
| 13.26 |  |
| V 24 03.00.22 | |
| T110 | 437 |
| 13.27 |  |
| V 24 03.00.23 | |
| T110 | 438 |
| 13.36 |  |
| V 24 03.00.37 | |
| T110 | 439 |
| 13.43 |  |
| V 24 03.00.47 | |
| T110 | 440 |
| 13.47 |  |
| 0.00 | |
| V 27 03.00.53 | |
| T111 | 441 |

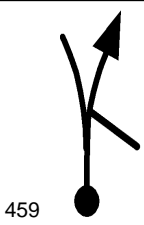
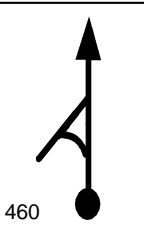
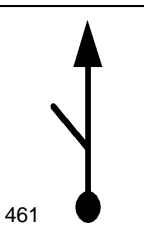
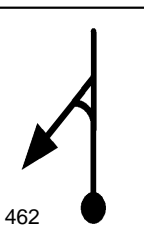

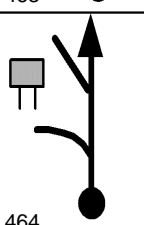

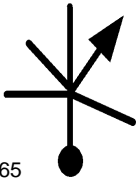
| | |
|---------------|---|
| 0.01 |  |
| V 33 03.00.54 | |
| T112 | 442 |
| 0.17 |  |
| V 33 03.01.12 | |
| T112 | 443 |
| 0.26 |  |
| N 1' 03.01.22 | |
| T113 | 444 |
| 0.26 |  |
| V 27 03.02.22 | |
| T114 | 445 |
| 0.38 |  |
| V 27 03.02.38 | |
| T114 | 446 |
| 0.46 |  |
| V 27 03.02.48 | |
| T114 | 447 |

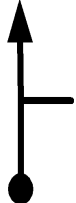
| | |
|---------------|---|
| 0.53 |  |
| V 27 03.02.58 | |
| T114 | 448 |
| 0.60 |  |
| V 27 03.03.07 | |
| T114 | 449 |
| 0.70 |  |
| V 27 03.03.20 | |
| T114 | 450 |
| 0.72 |  |
| V 27 03.03.23 | |
| T114 | 451 |
| 0.90 |  |
| V 27 03.03.47 | |
| T114 | 452 |
| 0.93 |  |
| V 27 03.03.51 | |
| T114 | 453 |

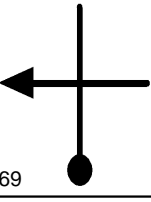
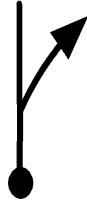
| | |
|-----------------|---|
| 1.19 |  |
| V 21 03.04.26 | |
| T115 | 454 |
| CUIDADO | |
| ROD. LUIZ ROSSO | |
| 1.23 |  |
| D 2' 03.04.33 | |
| T116 | 455 |
| ROD. LUIZ ROSSO | |
| 1.29 |  |
| D 2' | |
| T116 | 456 |
| ROD. LUIZ ROSSO | |
| 1.36 |  |
| D 2' | |
| T116 | 457 |
| ROD. LUIZ ROSSO | |
| 1.44 |  |
| V 30 03.06.33 | |
| T117 | 458 |

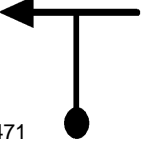
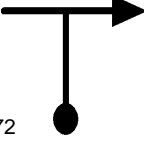
| | |
|---------------|---|
| 1.64 |  |
| V 30 03.06.57 | |
| T117 | 459 |
| 1.76 |  |
| V 30 03.07.11 | |
| T117 | 460 |
| 1.87 |  |
| V 30 03.07.24 | |
| T117 | 461 |
| 2.04 |  |
| V 30 03.07.45 | |
| T117 | 462 |
| 2.43 |  |
| V 30 03.08.31 | |
| T117 | 463 |
| 2.50 |  |
| V 27 03.08.40 | |
| T118 | 464 |

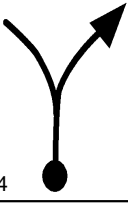
| | |
|---------------|---|
| 2.84 |  |
| V 24 03.09.25 | |
| T119 | 465 |
| 2.91 |  |
| N 1' 03.09.36 | |
| T120 | 466 |
| 2.91 |  |
| V 27 03.10.36 | |
| T121 | 467 |
| 2.95 |  |
| V 27 03.10.41 | |
| T121 | 468 |
| 3.06 |  |
| V 27 03.10.56 | |
| T121 | 469 |
| 3.07 |  |
| V 27 03.10.57 | |
| T121 | 470 |

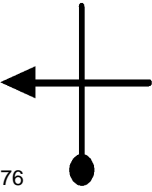
| | |
|---------------|---|
| 3.20 |  |
| V 27 03.11.14 | |
| T121 | 471 |
| 3.27 |  |
| V 18 03.11.24 | |
| T122 | 472 |
| 3.47 |  |
| V 27 03.12.04 | |
| T123 | 473 |
| 3.72 |  |
| V 27 03.12.37 | |
| T123 | 474 |
| 3.78 |  |
| V 30 03.12.45 | |
| T124 | 475 |
| 4.16 |  |
| V 30 03.13.31 | |
| T124 | 476 |

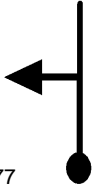
| | |
|-----------------|--|
| 4.34 |  |
| V 24 03.13.52 | |
| T125 477 | |

| | |
|-----------------|---|
| 4.46 |  |
| V 24 03.14.10 | |
| T125 478 | |

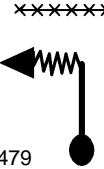

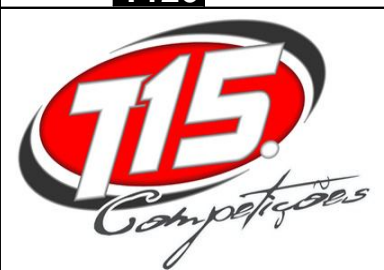

| | |
|-----------------|---|
| 4.55 | xxxxxxxx  |
| V 9 03.14.24 | |
| T126 479 | |



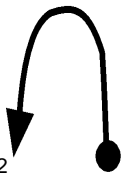
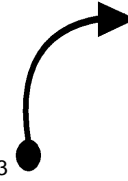
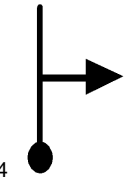
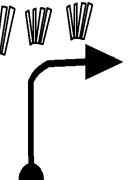
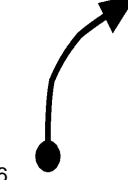
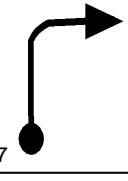

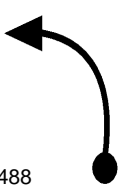
| | |
|-----------------|--|
| 4.61 |  |
| V 21 03.14.48 | |
| T127 480 | |

| | |
|-----------------|---|
| 4.68 |  |
| V 21 03.15.00 | |
| T127 481 | |

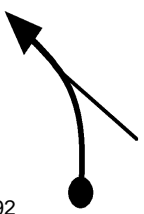
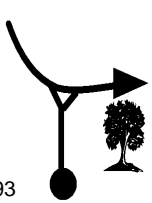
| | |
|---------------|---|
| 4.72 |  |
| V 21 03.15.06 | 482 |
| T127 | |
| 4.76 |  |
| V 21 03.15.13 | 483 |
| T127 | |
| 4.80 |  |
| V 27 03.15.20 | 484 |
| T128 | |
| ROÇA DE MILHO | |
| 4.87 |  |
| V 27 03.15.30 | 485 |
| T128 | |
| 5.08 |  |
| V 27 03.15.58 | 486 |
| T128 | |
| 5.30 |  |
| V 30 03.16.27 | 487 |
| T129 | |

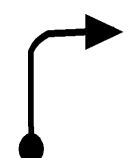
| | |
|---------------|---|
| 5.52 |  |
| V 30 03.16.53 | |
| T129 | 488 |
| 5.82 |  |
| V 21 03.17.29 | |
| T130 | 489 |
| 5.84 |  |
| V 21 03.17.33 | |
| T130 | 490 |
| 5.89 |  |
| V 21 03.17.41 | |
| T130 | 491 |
| 5.91 |  |
| V 18 03.17.45 | |
| T131 | 492 |
| 5.93 |  |
| V 18 03.17.49 | |
| T131 | 493 |

| | |
|-----------------|--|
| 6.05 |  |
| V 18 03.18.13 | |
| T131 494 | |

| | |
|-----------------|---|
| 6.07 |  |
| V 12 03.18.17 | |
| T132 495 | |

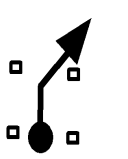
| | |
|-----------------|---|
| 6.10 |  |
| V 12 03.18.26 | |
| T132 496 | |

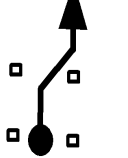
| | |
|-----------------|---|
| 6.11 |  |
| V 12 03.18.29 | |
| T132 497 | |

FIM DE PROVA

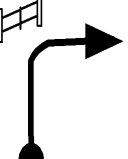
| | |
|-----------------|--|
| 6.18 |  |
| V 12 03.18.50 | |
| T132 498 | |

FIM DE PROVA !!



www.t15.com.br

Tempo de Prova

MÉDIA C 03:18:50

FIM
