



INICIO

MÉDIA B

PROVA DE REGULARIDADE TRILHEIROS DO MORREBA
27/10/2018



IMPORTANTE

-  **CUIDADO**
-  **ATENÇÃO**
-  **MUITA ATENÇÃO**

Tempo de Prova

MÉDIA B 03:12:35



AFERIÇÃO

DEVAGAR



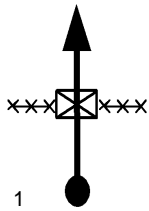

CRIANÇAS



0.00

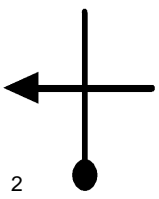

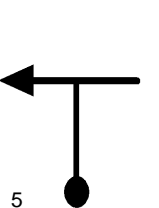

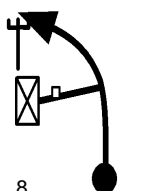
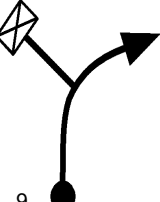
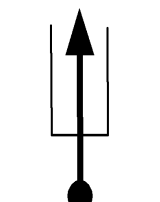

AFER

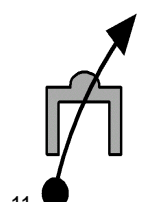

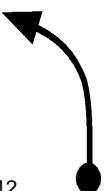

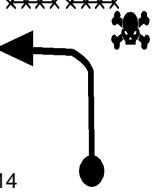
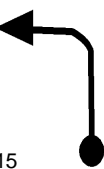
1

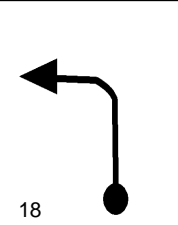
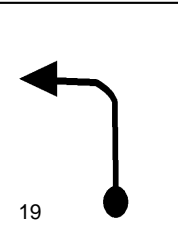
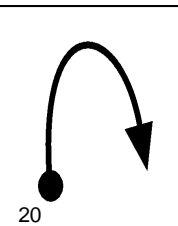
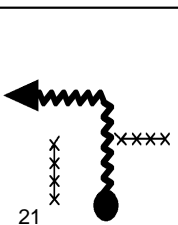
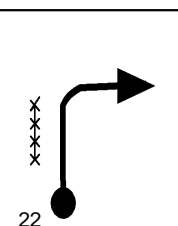
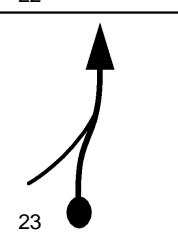

0.06	
AFER	2
0.09	
AFER	3
0.24	
AFER	4
0.40	
AFER	5
1.01	
AFER	6
1.40	
AFER	7

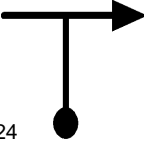
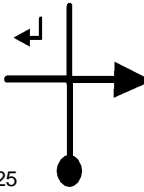
2.07	
AFER	8
2.22	
AFER	9
AFERIR INICIO LAJOTA	
2.45	
0.00	
AFER	10
	
INICIO DE PROVA	
INICIO DA PROVA	
0.00	
V 24 00.00.00	
T1	11



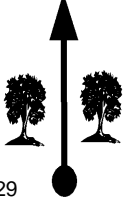

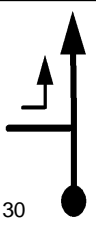
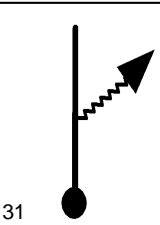
0.06	
V 24	
T1	12
0.34	
V 24	
T1	13
0.57	xxxxxxx 
V 24	
T1	14
0.78	
V 21 00.01.57	
T2	15
0.94	
V 21	
T2	16
0.98	
V 21	
T2	17

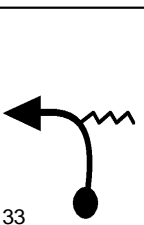
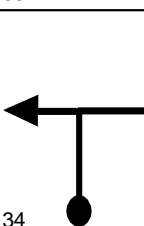
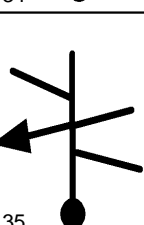

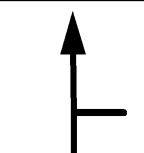
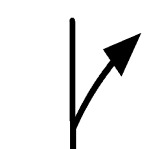
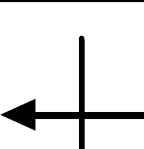
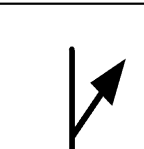
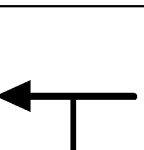
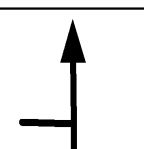
1.00	
V 21	
T2	18
1.07	
V 21	
T2	19
1.14	
V 21	
T2	20
1.29	
V 9 00.03.24	
T3	21
1.31	
V 27 00.03.32	
T4	22
1.40	
V 27	
T4	23

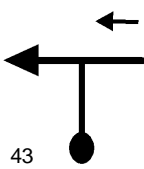
1.53	
V 27	24
T4	
1.69	
V 27	25
T4	
2.07	
V 27	26
T4	
2.13	
V 27	27
T4	
2.19	
V 27	28
T4	
2.43	
V 27	29
T4	

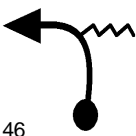
2.58	
V 27	
T4	30
2.63	
V 24 00.06.28	
T5	31
2.75	
V 24	
T5	32
2.87	
V 24	
T5	33
3.00	
V 30 00.07.24	
T6	34
3.29	
V 27 00.07.59	
T7	35

3.36	
V 27	36
3.40	
V 27	37
3.51	
V 27	38
3.53	
V 27	39
3.65	
V 27	40
3.67	
V 27	41

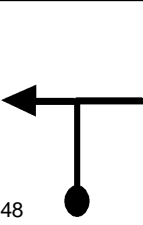
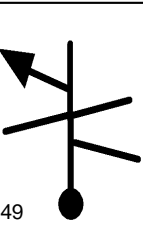
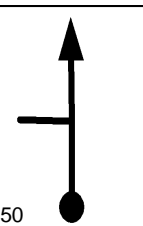
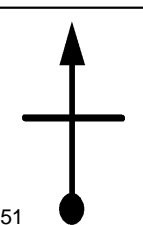
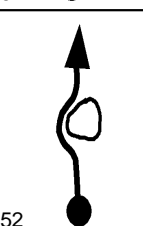
3.70	
V 27	42
T7	
3.73	
V 27	43
T7	
3.78	
V 27	44
T7	
3.90	
V 27	45
T7	
4.01	
V 27	46
T7	
4.15	
N 3' 00.09.53	47
T8	

4.15	
V 30 00.12.53	
T9	48
4.44	
V 24 00.13.28	
T10	49
4.48	
V 24	
T10	50
4.58	
V 24	
T10	51
4.62	
V 21 00.13.55	
T11	52
4.64	
V 21	
T11	53

4.70	
V 21	
T11	54

4.76	
V 21	
T11	55

EROSAO

4.81	
V 15 00.14.28	
T12	56

ACELERE PEDRA SABAO

4.85	
V 24 00.14.37	
T13	57

4.98	
V 24	
T13	58

5.25	
V 27 00.15.37	
T14	59







5.42	
V 27	
T14	60

5.57	
V 27	
T14	61

5.64	
V 27	
T14	62

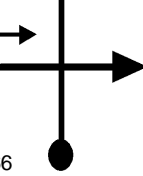
5.94	
V 27	
T14	63

6.03	
V 27	
T14	64

6.09	
V 27	65
T14	
6.22	
V 27	66
T14	
6.32	
V 27	67
T14	
6.38	
V 27	68
T14	
6.42	
V 27	69
T14	
6.44	
V 27	70
T14	

CUIDADO CERCA

A FRENTE

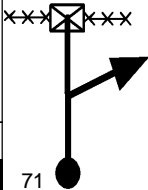
6.67 

V 18 00.18.47

 **T15** 71

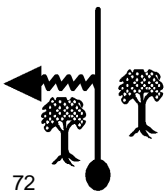
6.71 

V 18

T15 72

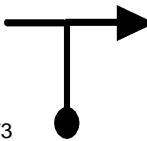
6.72 

V 27 00.18.57

T16 73

7.05 

N 3' 00.19.41

T17 74

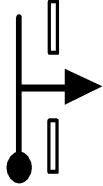
7.05 



V 27 00.22.41

T18 75

7.24 

V 27

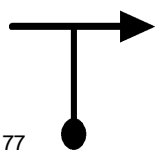
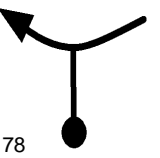
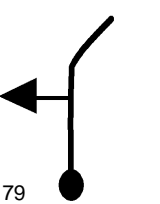
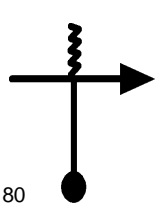
T18 76

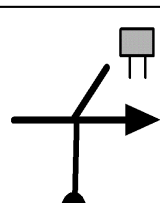
7.35	
V 27	
T18	77
7.54	
V 27	
T18	78
7.64	
V 27	
T18	79
7.68	
V 27	
T18	80
7.88	
0.00	
N 1' 00.24.31	
T19	81
0.00	
V 30 00.25.31	
T20	82

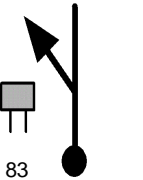
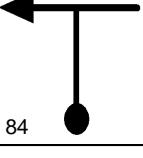
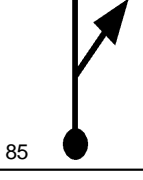
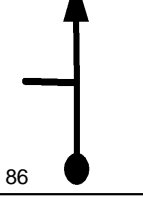
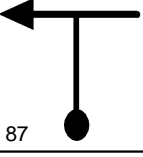
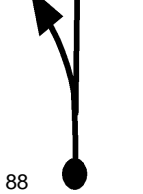
0.03	
V 30	
T20	83
0.24	
V 30	
T20	84
0.26	
V 30	
T20	85
0.34	
V 30	
T20	86
0.42	
V 30	
T20	87
0.43	
V 30	
T20	88

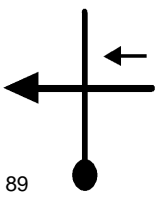
0.65	
V 30	
T20	89

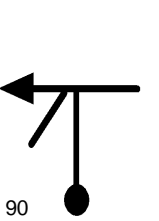
0.67	
V 30	
T20	90

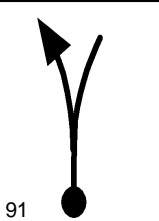

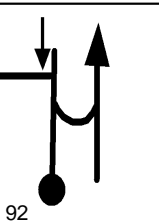

0.90	
V 30	
T20	91

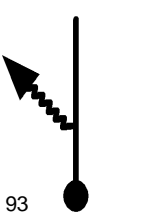

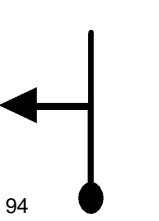

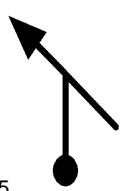
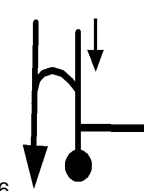
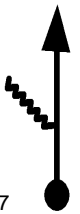
0.96	
V 30	
T20	92

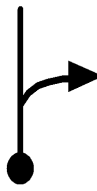

PINHEIRO

1.01	
V 30	
T20	93

1.23	
V 30	
T20	94

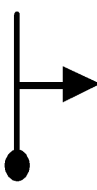
1.26	
V 30	
T20	95
1.50	
V 30	
T20	96
1.55	
V 33 00.28.37	
T21	97
1.77	
V 33	
T21	98
2.00	
V 33	
T21	99
2.12	
V 21 00.29.40	
T22	100

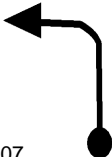
2.34	
V 30 00.30.17	
T23	101
2.36	
V 30	
T23	102
2.54	
V 30	
T23	103
2.67	
V 30	
T23	104
2.78	
V 30	
T23	105
2.84	
V 30	
T23	106

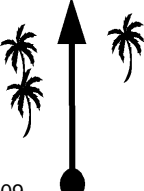
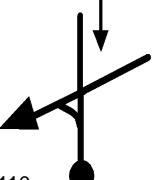
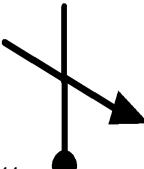
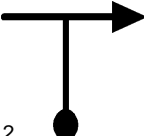
2.90	
V 30	
T23	107
3.00	
N 3' 00.31.36	
T24	108
3.00	
V 24 00.34.36	
T25	109
3.17	
V 15 00.35.02	
T26	110
3.22	
V 27 00.35.14	
T27	111
3.32	
V 27	
T27	112

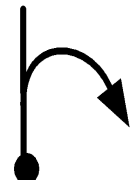
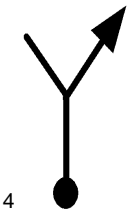
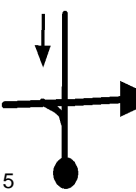
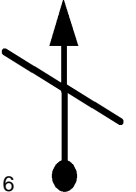
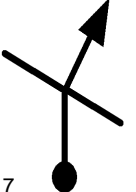
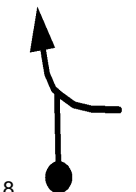
3.37	
V 27	
T27	113
3.44	
V 27	
T27	114
3.51	
V 27	
T27	115
3.56	
V 27	
T27	116
3.93	
V 27	
T27	117
3.96	
V 27	
T27	118

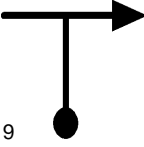
4.06	
V 27	
T27	119

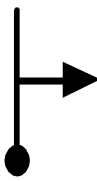

4.36	
V 27	
T27	120

4.37	
V 27	
T27	121

4.42	
V 27	
T27	122

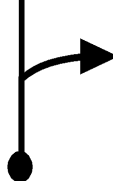
4.48	
V 27	
T27	123

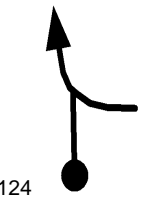
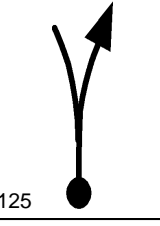
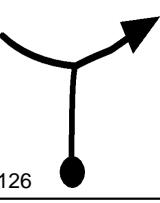
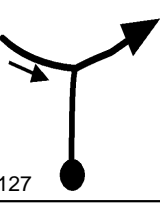
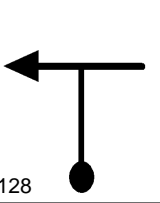
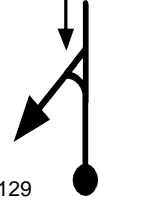
4.64	
V 27	
T27	124
4.65	
V 27	
T27	125
4.72	
V 27	
T27	126
4.80	
V 27	
T27	127
4.90	
V 36 00.38.58	
T28	128
5.16	
V 36	
T28	129

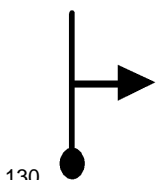
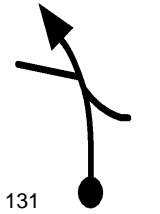
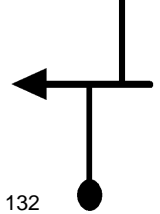
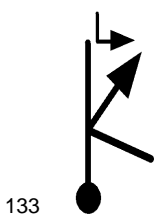
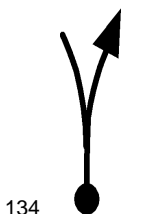
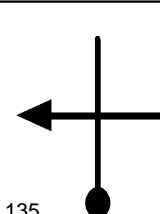
5.21	
V 24 00.39.29	
T29	130
5.31	
V 24	
T29	131
5.36	
V 27 00.39.51	
T30	132
5.40	
V 27 00.39.57	
T31	133
5.51	
V 27	
T31	134
5.61	
V 27	
T31	135

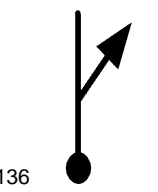
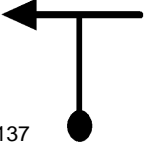
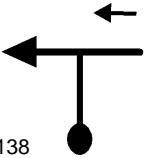
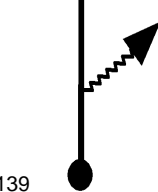
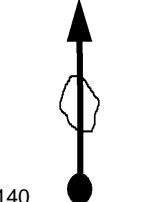
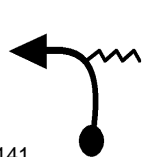
5.63	
V 27	
T31	136
5.75	
V 27	
T31	137
5.83	
V 27	
T31	138
5.89	
V 27	
T31	139
ATOLEIRO	
6.01	
V 27	
T31	140
6.12	
V 27	
T31	141

6.25	
V 30 00.41.50	
T32	142
7.02	
V 21 00.43.22	
T33	143
7.21	
N2'30s 00.43.55	
T34	144
7.21	
V 30 00.46.25	
T35	145
7.28	
V 30	
T35	146
7.97	
V 30	
T35	147

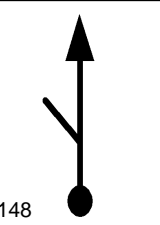
8.25	
V 30	
T35	148

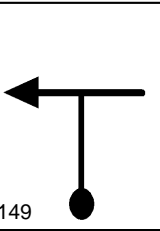
8.34	
V 30	
T35	149

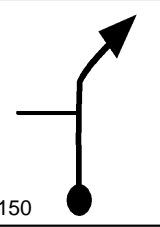

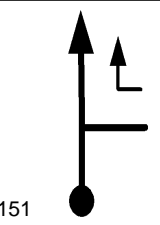

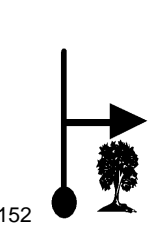

8.41	
V 30	
T35	150

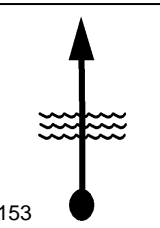

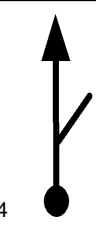



8.51	
V 30	
T35	151

GOIABEIRA

8.71	
V 30	
T35	152

8.97	
V 30	
T35	153

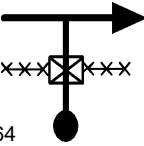
9.15	
V 30	
T35	154
9.41	
V 30	
T35	155
9.50	
V 30	
T35	156
9.64	
V 30	
T35	157
9.77	
V 30	
T35	158
10.03	
V 30	
T35	159

10.09	
V 30 T35 160	
10.37	
V 9 00.52.44 T36 161	
10.41	
V 9 T36 162	
10.50	
0.00 N 3' 00.53.36 T37 163	
0.00	
V 30 00.56.36 T38 164	
0.43	
V 21 00.57.28 T39 165	

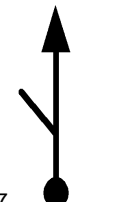
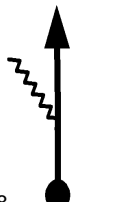
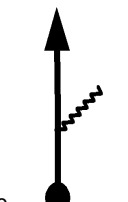
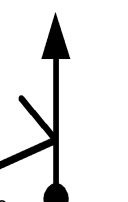
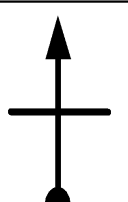
0.62	
V 30 00.58.00	
T40	166
0.68	
V 30	
T40	167
0.81	
V 30	
T40	168
1.04	
V 30	
T40	169
1.13	
V 30	
T40	170
1.29	
V 30	
T40	171

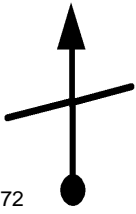
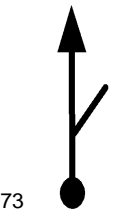
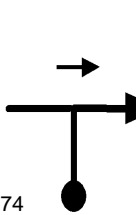
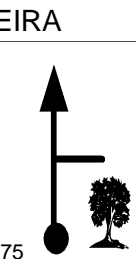
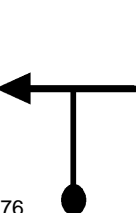
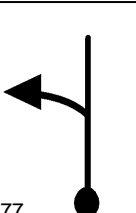
1.56	
V 30	
T40	172
1.63	
V 30	
T40	173
1.68	
V 33 01.00.08	
T41	174
GOIABEIRA	
1.88	
V 33	
T41	175
2.07	
V 33	
T41	176
2.30	
V 33	
T41	177

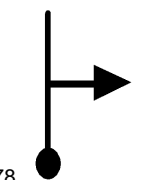
2.63	
V 30 01.01.51	
T42	178

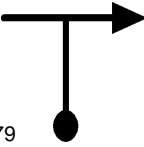

2.77	
V 30	
T42	179

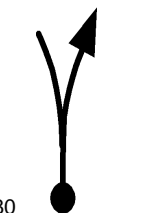

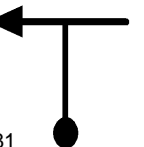

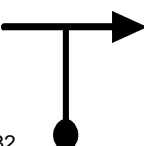
2.83	
V 30	
T42	180

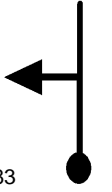
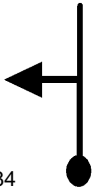
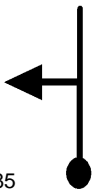
2.90	
V 30	
T42	181

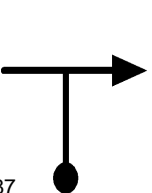
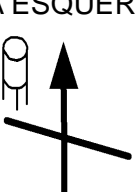
3.03	
V 30	
T42	182

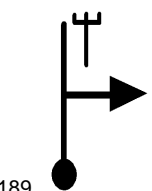
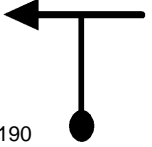
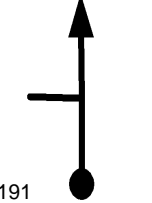
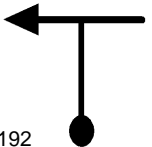
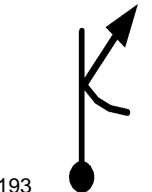
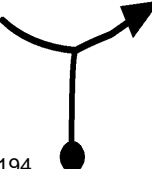
3.05	
V 30	
T42	183
3.14	
V 30	
T42	184
3.63	
V 30	
T42	185
4.00	
N 3' 01.04.36	
T43	186
4.00	
V 33 01.07.36	
T44	187
CAIXA D'AGUA A ESQUERDA	
4.29	
V 33	
T44	188

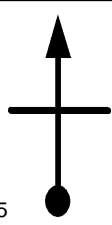
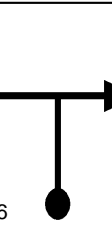
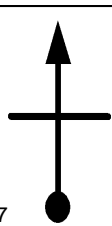
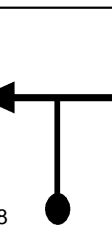
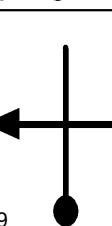
4.55	
V 33 01.08.36	
T45	189
4.81	
V 33	
T45	190
4.86	
V 33	
T45	191
4.89	
V 33	
T45	192
5.01	
V 33	
T45	193
5.12	
V 24 01.09.38	
T46	194

5.14	
V 24	
T46	195
5.15	
V 24	
T46	196
5.17	
V 24	
T46	197
5.27	
V 24	
T46	198
5.31	
V 24	
T46	199
5.41	
V 24	
T46	200

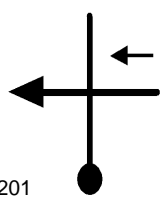
5.44	
V 24	
T46	201

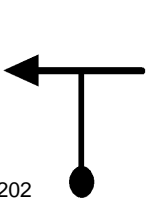
5.54	
V 24	
T46	202

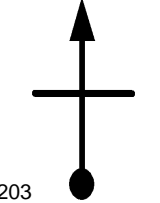
5.57	
V 24	
T46	203

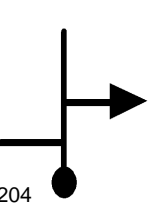
5.61	
V 24	
T46	204

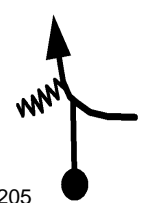
5.80	
V 27 01.11.20	
T47	205

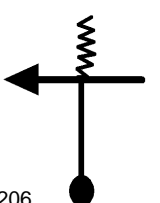
5.92	
V 27	
T47	206

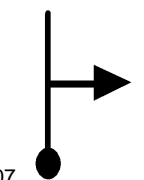
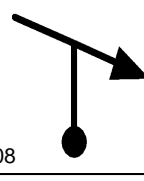
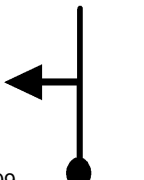
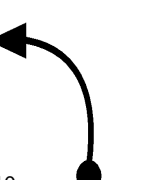
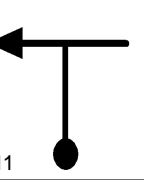
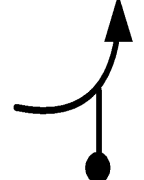
5.99	
V 27	
T47	207
6.16	
V 27	
T47	208
6.25	
V 27	
T47	209
6.30	
V 33 01.12.26	
T48	210
6.59	
V 33	
T48	211
6.66	
V 33	
T48	212

7.07	
V 33	
T48 213	

IGREJA

7.69	
Nº'30s 01.14.58	
T49 214	

7.69	
V 36 01.17.28	
T50 215	

7.97	
V 33 01.17.56	
T51 216	

8.44	
V 36 01.18.47	
T52 217	

8.55	
V 36	
T52 218	

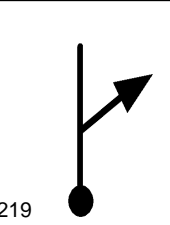
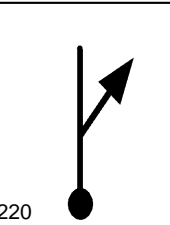
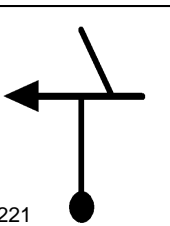
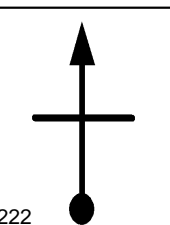
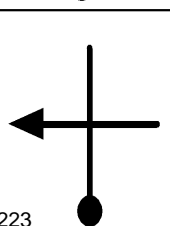
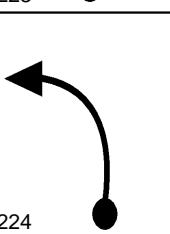
8.56	
V 36	
T52	219
8.66	
V 36	
T52	220
8.88	
V 27 01.19.31	
T53	221
8.91	
V 27	
T53	222
8.94	
V 27	
T53	223
9.14	
V 27	
T53	224

9.16	
V 27	
T53	225
9.36	
V 27	
T53	226
9.38	
V 27	
T53	227
9.59	
V 27	
T53	228
9.61	
V 30 01.21.09	
T54	229
9.84	
V 30	
T54	230

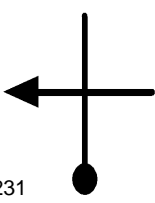
9.96	
V 30	
T54	231

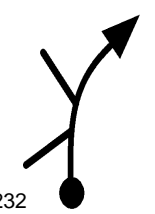
9.99	
V 30	
T54	232

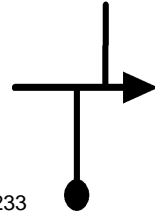
10.09	
V 30	
T54	233

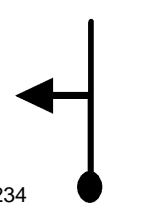
10.19	
V 30	
T54	234

10.32	
0.00	
N 2' 01.22.34	
T55	235

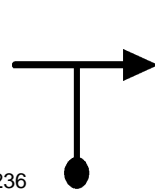
0.00	
V 27 01.24.34	
T56	

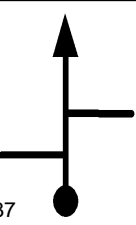
0.13	
V 27	
T56	237

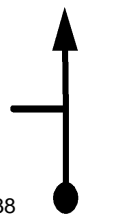
0.22	
V 27	
T56	238

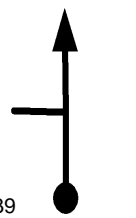
0.41	
V 27	
T56	239



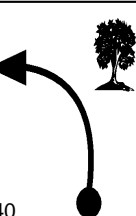

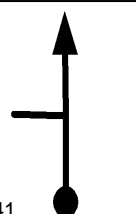

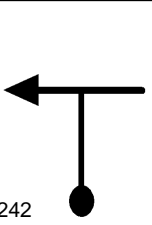
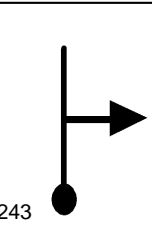
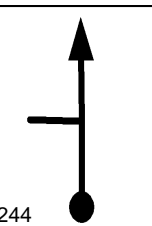
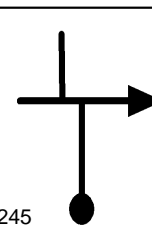
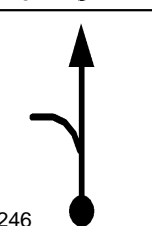
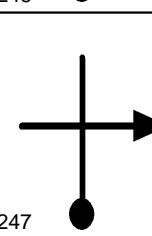
0.43	
V 27	
T56	240

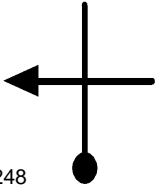
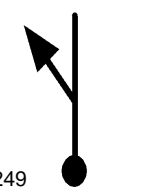
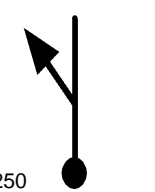
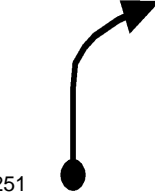
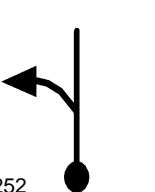
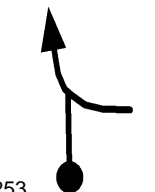

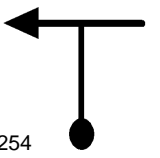
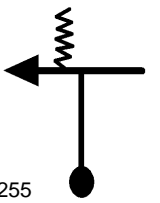
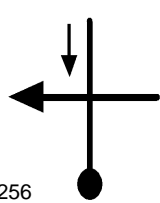
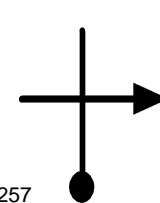
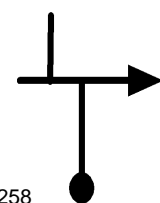
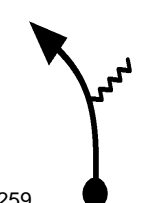

0.57	
V 27	
T56	241

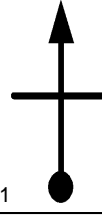
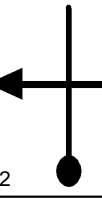
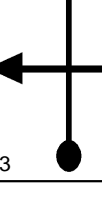
0.60	
V 27	
T56	242
0.70	
V 27	
T56	243
0.77	
V 27	
T56	244
0.81	
V 27	
T56	245
0.82	
V 27	
T56	246
0.91	
V 27	
T56	247

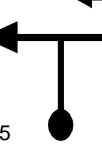
0.97	
V 27	
T56	248
1.07	
V 27	
T56	249
1.14	
V 27	
T56	250
1.18	
V 27	
T56	251
1.20	
V 27	
T56	252
1.23	
V 27	
T56	253

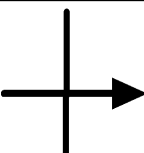
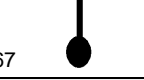
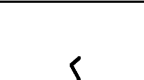
1.27	
V 27	254
1.32	
V 27	255
1.35	
V 27	256
1.41	
V 27	257
1.52	
V 27	258
1.79	
V 27	259

2.14	
V 30 01.29.19	
T57	260
2.20	
V 30	
T57	261
2.60	
V 30	
T57	262
2.64	
V 30	
T57	263
3.02	
V 30	
T57	264
3.05	
V 30	
T57	265

3.43	
V 30	
T57	266
3.65	
V 24 01.32.20	
T58	267
3.83	
V 30 01.32.47	
T59	268
3.92	
V 30	
T59	269
4.25	
V 30	
T59	270
4.35	
V 30	
T59	271

4.91
D1'30s 01.34.57
T60 272

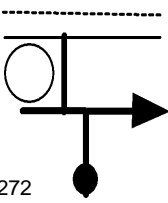

5.24
D1'30s
T60 273

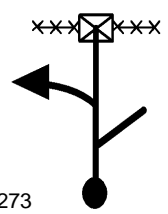

5.29
D1'30s
T60 274

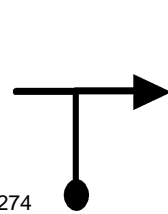

5.31
D1'30s
T60 275

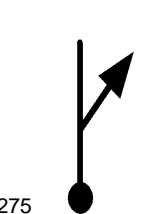

APOIO 2° ETAPA
5.31
0.00
N 15' 01.36.27
T61 276



0.00
D1'30s 01.51.27
T62 277

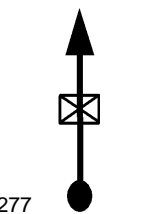

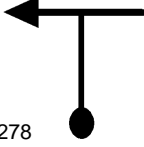
0.01	
D1'30s	
T62	278

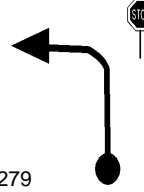
0.08	
D1'30s	
T62	279

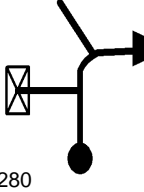
0.12	
D1'30s	
T62	280

RODOVIA

LUIZ ROSSO

0.46	
D1'30s	
T62	281

0.60	
D1'30s	
T62	282

1.05	
D1'30s	
T62	283

1.18	
V 51 01.52.57	
T63 284	
OLARIA	
2.03	
V 51	
T63 285	
3.16	
V 51	
T63 286	
4.11	
V 24 01.56.24	
T64 287	
VIADUTO	
4.29	
V 24	
T64 288	
4.36	
V 15 01.57.01	
T65 289	

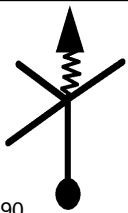
4.38	
V 15	
T65	290

4.61	
V 15	
T65	291

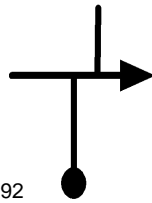
4.79	
V 27 01.58.45	
T66	292

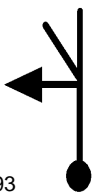
4.96	
V 33 01.59.07	
T67	293

CUIDADO ROÇA

DONO BRABO

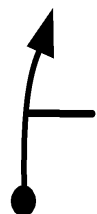
5.11	
V 33	
T67	294

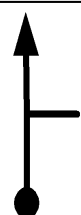
5.22	
V 33	
T67	295

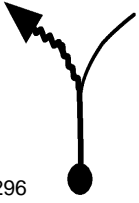
5.93	
V 18 02.00.53	
T68	296

5.99	
V 18	
T68	297

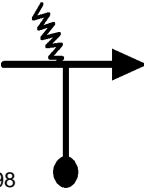
6.04	
V 18	
T68	298

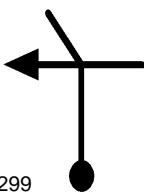
6.09	
V 30 02.01.25	
T69	299

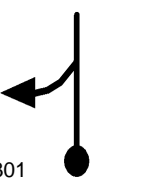
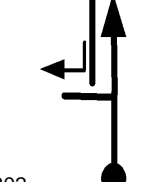
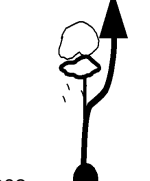
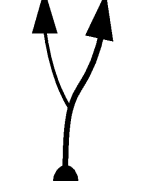
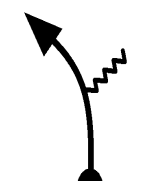
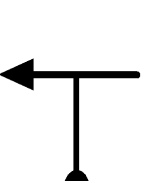

6.22	
N 2' 02.01.41	
T70	300

6.22	
V 18 02.03.41	
T71	301
BAMP	
6.56	
V 18	
T71	302
6.68	
V 18	
T71	303
7.17	
V 15 02.06.51	
T72	304
7.21	
V 15 02.07.00	
T73	305
7.24	
V 15	
T73	306

CUIDADO

7.27

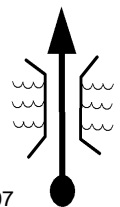

V 15

T73

307

7.40



V 21 02.07.46

T74

308

7.55



V 30 02.08.12

T75

309

7.60



V 30

T75

310

SIGA PELA DIREITA

7.84

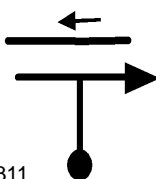

V 30

T75

311

7.95

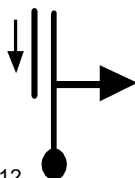

V 30

T75

312

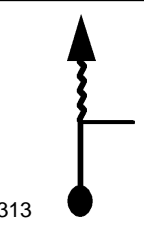
8.08	
V 9 02.09.15	
T76	313

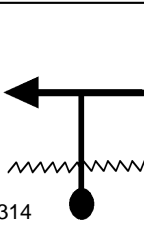
8.15	
V 9	
T76	314

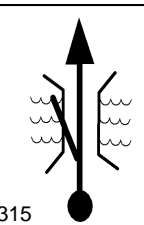
8.18	
V 9	
T76	315

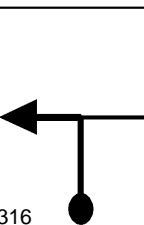
8.19	
V 9	
T76	316

ACELERE

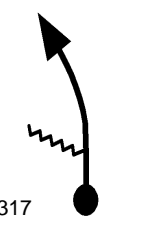
8.28	
V 9	
T76	317

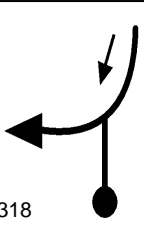
8.60	
V 15 02.12.43	
T77	318

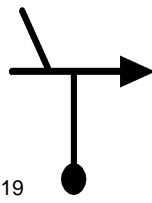
8.65	
V 15	
T77	319

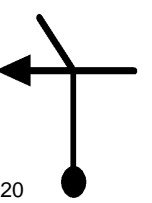
8.69	
V 30 02.13.05	
T78	320



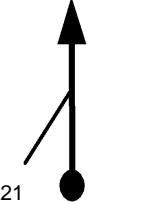

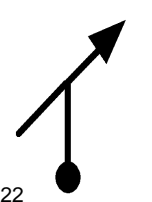

TRILHA DO TONINHO
QUEBRA CLAVICULA

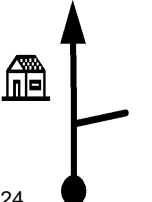
8.83	
V 30	
T78	321

9.12	
V 30	
T78	322

9.14	
V 30	
T78	323

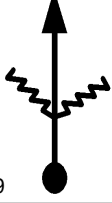
9.16	
V 30	
T78	324

9.45	
0.00	
N 3' 02.14.36	
T79	325
0.00	
V 15 02.17.36	
T80	326
0.05	
V 18 02.17.48	
T81	327
0.07	
V 18	
T81	328
0.12	
V 18	
T81	329
0.15	
V 18	
T81	330

SUBIDA CUIDADO

COQUEIRO APÓS SUBIDA

0.24

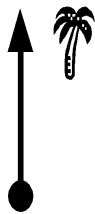

V 18



T81

331

ATENÇÃO

CORRIGIR ODOMETRO

0.32

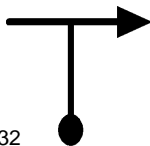

V 27 02.18.42



T82

332

0.51



V 27

T82

333

0.56

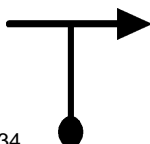

V 27

T82

334









0.86

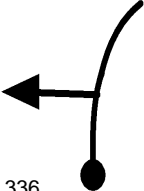
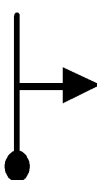

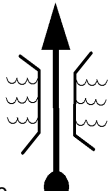

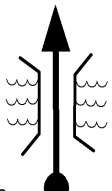
V 27

T82

335

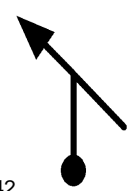
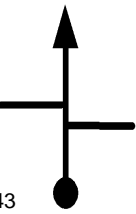
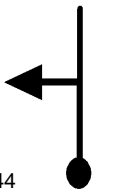
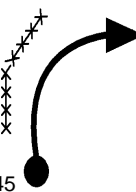
1.21	
V 24 02.20.41	
T83	336
1.25	
V 24	
T83	337
1.26	
V 12 02.20.48	
T84	338
1.34	
V 12 02.21.12	
 T85	339
1.54	
V 12	
 T85	340
1.73	
V 12	
 T85	341

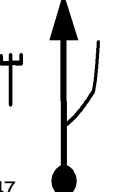
1.79	
V 30 02.23.27	
T86	342
1.81	
V 30	
T86	343
2.15	
V 24 02.24.10	
T87	344
2.21	
V 24	
T87	345
2.27	
V 24	
T87	346
2.33	
V 24	
T87	347

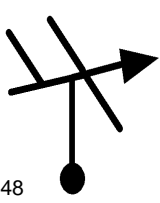
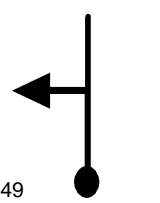
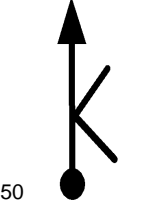
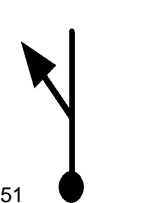
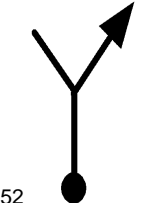
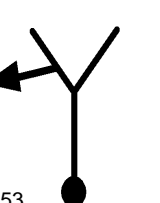
2.51	
V 24	
T87	348
2.82	
V 30 02.25.51	
T88	349
3.20	
V 30	
T88	350
3.29	
V 27 02.26.47	
T89	351
3.35	
V 27	
T89	352
3.47	
V 27	
T89	353

3.52	
V 27	
T89	354
3.60	
V 27	
T89	355
3.66	
V 27	
T89	356
3.91	
Nº'30s 02.28.10	
T90	357
3.91	
V 27 02.30.40	
T91	358
ATOLEIRO	
3.95	
V 12 02.30.45	
T92	359



4.12	
V 24 02.31.36	
T93	360





4.29	
V 24	
T93	361

4.32	
V 24	
T93	362

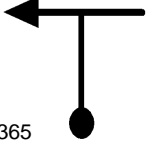
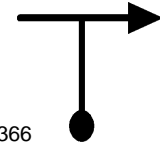
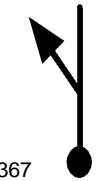
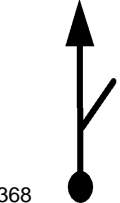
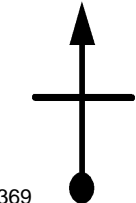
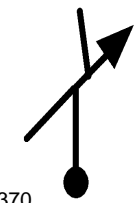

4.34	
V 24	
T93	363

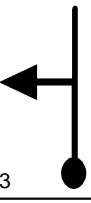

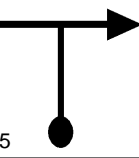
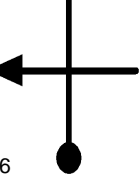

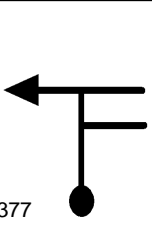
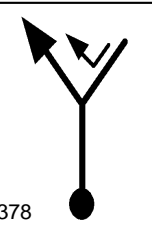
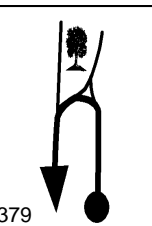
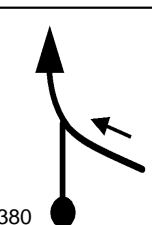
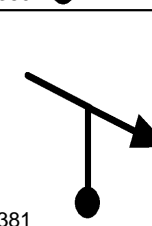
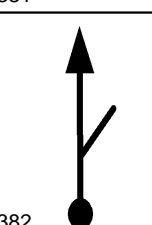
4.35	
V 24	
T93	364

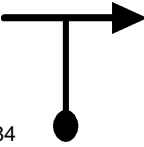
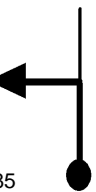
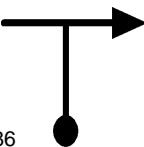
4.48	
V 24	365
4.49	
V 30 02.32.32	366
4.56	
V 30	367
4.58	
V 30	368
4.72	
V 30	369
4.91	
V 30	370

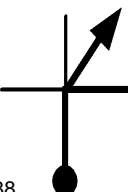
4.99	
V 30	
T94	371
5.02	
V 30	
T94	372
5.05	
V 30	
T94	373
5.09	
V 30	
T94	374
5.17	
V 30	
T94	375
5.28	
V 30	
T94	376

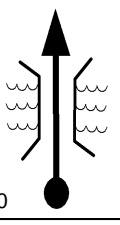

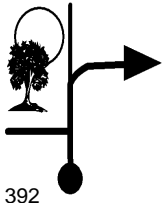
5.29	
V 30	
T94	377
5.34	
V 30	
T94	378
5.59	
V 30	
T94	379
5.68	
V 27 02.34.55	
T95	380
5.76	
V 27	
T95	381
5.95	
V 27	
T95	382

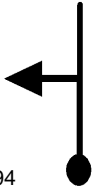

6.00	
V 27	
T95	383
6.32	
V 27	
T95	384
6.34	
V 27	
T95	385
6.52	
V 27	
T95	386
6.68	
V 27	
T95	387
6.78	
V 27	
T95	388

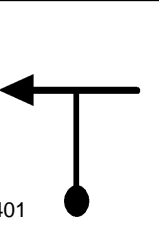
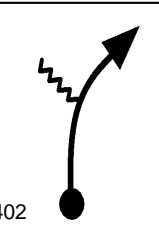
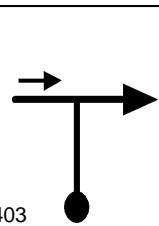
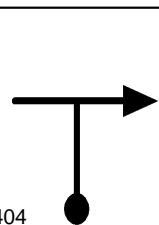
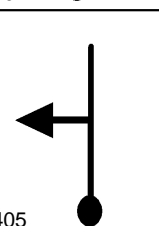
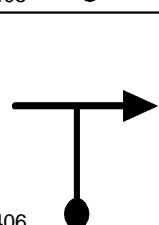
6.88	
V 27	
T95	389
7.20	
V 27	
T95	390
7.28	
N 2' 02.38.28	
T96	391
CAIXA D'ÁGUA A ESQUERDA	
7.28	
V 30 02.40.28	
T97	392
7.52	
V 30	
T97	393
7.67	
V 24 02.41.15	
T98	394

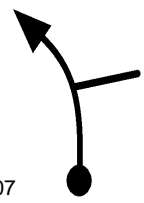
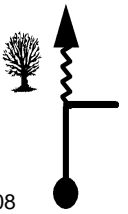
7.74	
V 24	
T98	395
7.76	
V 24	
T98	396
7.78	
V 24	
T98	397
7.83	
V 24	
T98	398
7.93	
V 30 02.41.54	
T99	399
7.99	
V 30	
T99	400

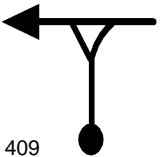
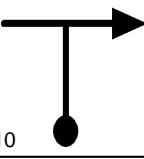
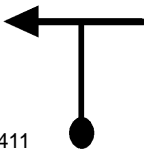
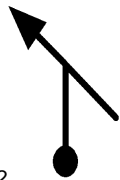
8.25	
V 33 02.42.32	
T100	401
8.39	
V 33	
T100	402
8.68	
V 33	
T100	403
8.76	
V 33	
T100	404
8.77	
V 33	
T100	405
8.95	
V 33	
T100	406

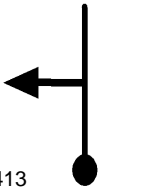
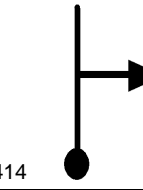
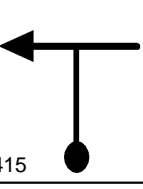
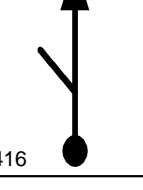
9.11	
V 27 02.44.06	
T101 407	
LARANGEIRA	
9.37	
V 12 02.44.41	
 T102 408	
9.40	
V 12	
T102 409	
9.47	
V 21 02.45.11	
T103 410	
9.53	
V 21	
T103 411	
9.84	
V 30 02.46.14	
T104 412	

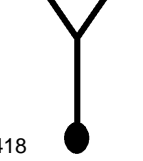
10.16	
V 30	
T104 ⁴¹³	
10.32	
V 30	
T104 ⁴¹⁴	
10.48	
V 30	
T104 ⁴¹⁵	
10.52	
V 30	
T104 ⁴¹⁶	
10.56	
N1'30s 02.47.40	
T105 ⁴¹⁷	
10.56	
V 24 02.49.10	
T106 ⁴¹⁸	

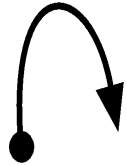
10.76	
V 24	
T106	419





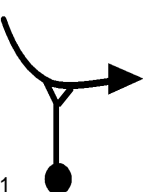

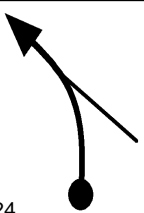
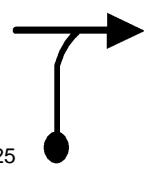
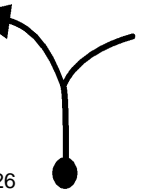
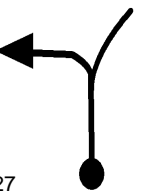
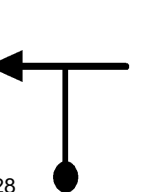

10.95	
V 24	
T106	420

10.99	
V 33 02.50.15	
T107	421

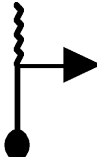

11.17	
V 33	
T107	422



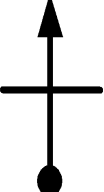

11.29	
V 33	
T107	423

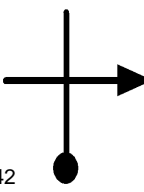

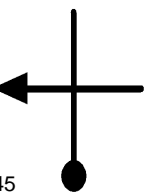
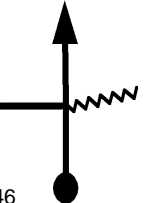
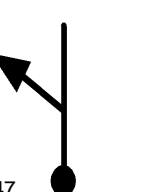
11.39	
V 33	
T107	424
11.54	
V 36 02.51.15	
T108	425
11.70	
V 36	
T108	426
11.91	
V 36	
T108	427
11.95	
V 36	
T108	428
12.33	
V 18 02.52.34	
T109	429

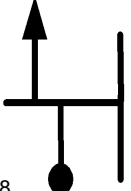

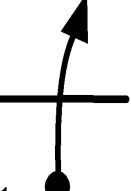
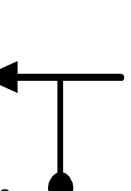

12.48	
V 18	
T109	430
12.51	
V 18	
T109	431
12.59	
V 27 02.53.26	
T110	432
12.83	
V 27	
T110	433
13.12	
V 27	
T110	434
13.14	
V 27	
T110	435

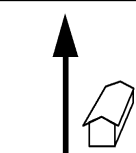
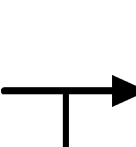
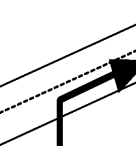
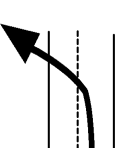





13.21	
V 27	
T110	436
13.26	
V 27	
T110	437
13.27	
V 27	
T110	438
13.36	
V 27	
T110	439
13.43	
V 27	
T110	440
13.47	
0.00	
V 30 02.55.23	
T111	441

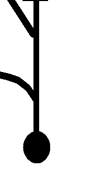

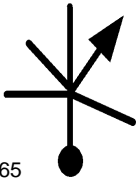

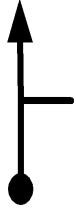
0.01	
V 36 02.55.24	
T112 442	
0.17	
V 36	
T112 443	
0.26	
N1'30s 02.55.49	
T113 444	
0.26	
V 30 02.57.19	
T114 445	
0.38	
V 30	
T114 446	
0.46	
V 30	
T114 447	

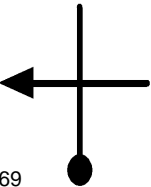
0.53	
V 30	
T114	448
0.60	
V 30	
T114	449
0.70	
V 30	
T114	450
0.72	
V 30	
T114	451
0.90	
V 30	
T114	452
0.93	
V 30	
T114	453

1.19	
V 21 02.59.11	
T115	454
CUIDADO	
ROD. LUIZ ROSSO	
1.23	
D 2' 02.59.18	
T116	455
ROD. LUIZ ROSSO	
1.29	
D 2'	
T116	456
ROD. LUIZ ROSSO	
1.36	
D 2'	
T116	457
1.44	
V 33 03.01.18	
T117	458

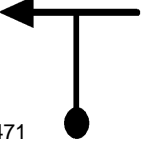
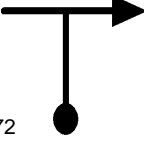
1.64	
V 33	
T117	459
1.76	
V 33	
T117	460
1.87	
V 33	
T117	461
2.04	
V 33	
T117	462
2.43	
V 33	
T117	463
2.50	
V 30 03.03.13	
T118	464

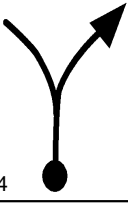
2.84	
V 27 03.03.54	
T119	465
2.91	
N 1' 03.04.04	
T120	466
2.91	
V 30 03.05.04	
T121	467
2.95	
V 30	
T121	468
3.06	
V 30	
T121	469
3.07	
V 30	
T121	470

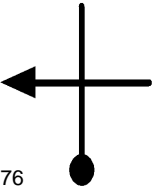
3.20	
V 30	
T121	471
3.27	
V 21 03.05.47	
T122	472
3.47	
V 30 03.06.21	
T123	473
3.72	
V 30	
T123	474
3.78	
V 33 03.06.58	
T124	475
4.16	
V 33	
T124	476

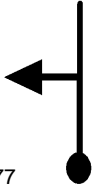
4.34	
V 27 03.07.59	
T125	477

4.46	
V 27	
T125	478

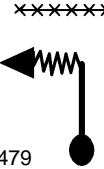

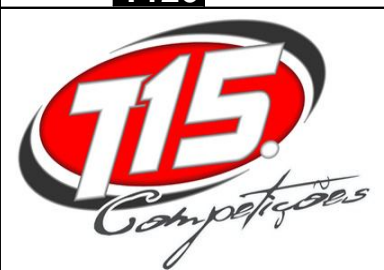

4.55	xxxxxxxxx 
V 9 03.08.27	
T126	479



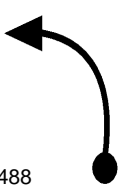

4.61	
V 21 03.08.51	
T127	480

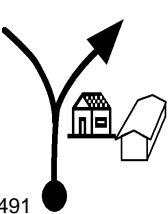
4.68	
V 21	
T127	481

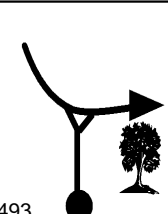
4.72	
V 21	
T127	482
4.76	
V 21	
T127	483
4.80	
V 30 03.09.24	
T128	484
ROÇA DE MILHO	
4.87	
V 30	
T128	485
5.08	
V 30	
T128	486
5.30	
V 33 03.10.24	
T129	487

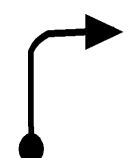
5.52	
V 33	
T129	488
5.82	
V 24 03.11.21	
T130	489
5.84	
V 24	
T130	490
5.89	
V 24	
T130	491
5.91	
V 21 03.11.34	
T131	492
5.93	
V 21	
T131	493

6.05	
V 21	
T131 494	

6.07	
V 12 03.12.02	
T132 495	

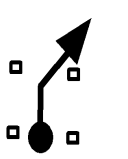
6.10	
V 12	
T132 496	

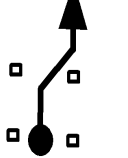
6.11	
V 12	
T132 497	

FIM DE PROVA

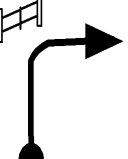
6.18	
V 12 03.12.35	
T132 498	

FIM DE PROVA !!



www.t15.com.br

Tempo de Prova

MÉDIA B 03:12:35

FIM
