

INICIO**MÉDIA A****MÉDIA B****MÉDIA C****MÉDIA D**COPA MTC - SIDERÓPOLIS
EQUIPE BICHO DO MATO**IMPORTANTE**

A PLANILHA POSSUI 4
MÉDIAS.
EM CONDIÇÕES NORMAIS DE
TEMPO

Média "A" para Graduados
Média "B" para Over 40 e
Júnior

Média "C" para Over 45,
Duplas e Estreantes

EM CASO DE MÉDIA DE
CHUVA

Média "B" para Graduados
Média "C" para Over 40 e
Júnior

Média "D" para Over 45,
Duplas e Estreantes

A DECISÃO É DA
ORGANIZAÇÃO DA PROVA ATÉ
3 HORAS DA LARGADA!!

CUIDADO
ATENÇÃO
MUITA ATENÇÃO
**Tempo de Prova**

MÉDIA A 02:58:37

MÉDIA B 03:08:01

MÉDIA C 03:19:15

MÉDIA D 03:39:08

**AFERIÇÃO**

ZERAR NO POSTE



0.00

1 **AFER**

0.34

2 **AFER**

0.60

3 **AFER**

0.84

4 **AFER**

1.46

5 **AFER**

FINAL DA AFERIÇÃO

RETORNE PARA A LARGADA



1.60

0.00

6 **AFER****INICIO DE PROVA**

0.00

V 36 00.00.00

V 33 00.00.00

V 30 00.00.00

V 27 00.00.00

7 **T1**

0.11

V 36 00.00.11

V 33 00.00.12

V 30 00.00.13

V 27 00.00.15

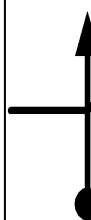
8 **T1**

0.19

V 36 00.00.19

V 33 00.00.21

V 30 00.00.23

V 27 00.00.25

9 **T1**

0.27

V 36 00.00.27

V 33 00.00.29

V 30 00.00.32





V 27 00.00.36



10 **T1**

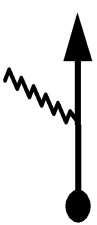
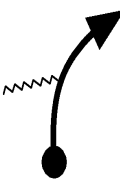

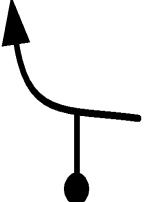
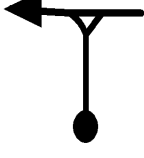

EQUIPE BICHO DO MATO		Pág: 004	
	0.45	V 36	00.00.45
		V 33	00.00.49
		V 30	00.00.54
		V 27	00.01.00
	11	T1	
	0.72	V 36	00.01.12
		V 33	00.01.19
		V 30	00.01.26
		V 27	00.01.36
	12	T1	
DEVAGAR			
	1.03	V 15	00.01.43
		V 15	00.01.52
		V 15	00.02.04
		V 12	00.02.17
	13	T2	
	1.20	V 39	00.02.24
		V 36	00.02.33
		V 33	00.02.44
		V 30	00.03.08
	14	T3	
	1.60	V 39	00.03.01
		V 36	00.03.13
		V 33	00.03.28
		V 30	00.03.56
	15	T3	
	1.76	V 39	00.03.15
		V 36	00.03.29
		V 33	00.03.45
		V 30	00.04.16
	16	T3	

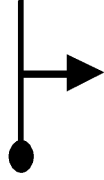
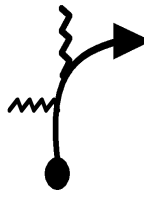
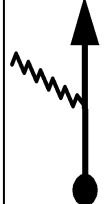

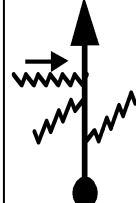
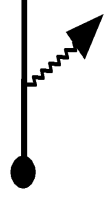
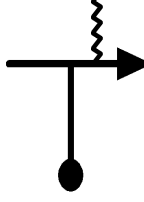
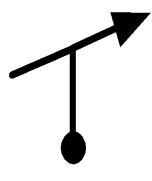

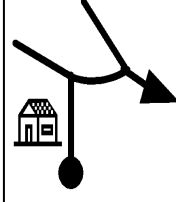
EQUIPE BICHO DO MATO		Pág: 005	
	2.09	V 39	00.03.46
		V 36	00.04.02
		V 33	00.04.21
		V 30	00.04.55
	17	T3	
	2.58	V 39	00.04.31
		V 36	00.04.51
		V 33	00.05.15
		V 30	00.05.54
	18	T3	
	2.68	V 39	00.04.40
		V 36	00.05.01
		V 33	00.05.26
		V 30	00.06.06
	19	T3	
	2.79	V 39	00.04.51
		V 36	00.05.12
		V 33	00.05.38
		V 30	00.06.19
	20	T3	
	3.06	V 39	00.05.15
		V 36	00.05.39
		V 33	00.06.07
		V 30	00.06.52
	21	T3	
	3.30	V 39	00.05.38
		V 36	00.06.03
		V 33	00.06.33
		V 30	00.07.20
	22	T3	
	3.40	V 39	00.05.47
		V 36	00.06.13
		V 33	00.06.44
		V 30	00.07.32
	23	T3	

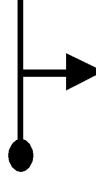
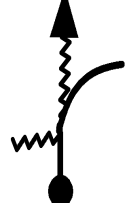
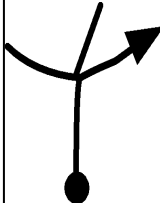

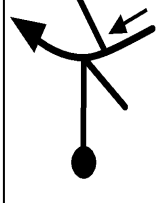

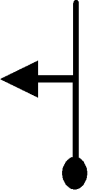

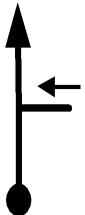
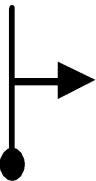
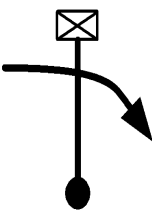
EQUIPE BICHO DO MATO		Pág: 006	
	3.42	V 39	00.05.49
		V 36	00.06.15
		V 33	00.06.47
		V 30	00.07.35
	24	T3	
	3.46	V 39	00.05.52
		V 36	00.06.19
		V 33	00.06.51
		V 30	00.07.40
	25	T3	
	3.53	V 39	00.05.59
		V 36	00.06.26
		V 33	00.06.59
		V 30	00.07.48
	26	T3	
	3.81	N 30s	00.06.25
		N 30s	00.06.54
		N 30s	00.07.29
		N 30s	00.08.22
	27	T4	
	3.81	V 39	00.06.55
		V 36	00.07.24
		V 33	00.07.59
		V 30	00.08.52
	28	T5	
	4.01	V 30	00.07.13
		V 27	00.07.44
		V 24	00.08.21
		V 21	00.09.16
	29	T6	
	4.11	V 30	00.07.25
		V 27	00.07.57
		V 24	00.08.36
		V 21	00.09.33
	30	T6	



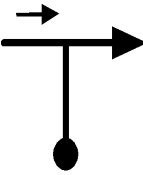
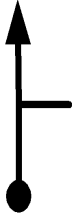

EQUIPE BICHO DO MATO		Pág: 007	
	4.30	V 30	00.07.48
		V 27	00.08.23
		V 24	00.09.04
		V 21	00.10.05
	31	T6	
	4.62	V 42	00.08.26
		V 39	00.09.05
		V 36	00.09.52
		V 33	00.11.00
	32	T7	
	4.81	V 42	00.08.43
		V 39	00.09.23
		V 36	00.10.11
		V 33	00.11.21
	33	T7	
	5.43	V 42	00.09.36
		V 39	00.10.20
		V 36	00.11.13
		V 33	00.12.28
	34	T7	
	5.92	V 42	00.10.18
		V 39	00.11.05
		V 36	00.12.02
		V 33	00.13.22
	35	T7	
	6.22	V 42	00.10.44
		V 39	00.11.33
		V 36	00.12.32
		V 33	00.13.55
	36	T7	
	6.46	V 42	00.11.04
		V 39	00.11.55
		V 36	00.12.56
		V 33	00.14.21
	37	T7	

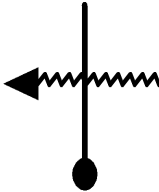
EQUIPE BICHO DO MATO		Pág: 008	
	6.58	V 42	00.11.14
		V 39	00.12.06
		V 36	00.13.08
		V 33	00.14.34
	38	T7	
	6.65	V 42	00.11.20
		V 39	00.12.13
		V 36	00.13.15
		V 33	00.14.42
	39	T7	
	6.66	V 42	00.11.21
		V 39	00.12.14
		V 36	00.13.16
		V 33	00.14.43
	40	T7	
			
	6.90	V 42	00.11.42
		V 39	00.12.36
		V 36	00.13.40
		V 33	00.15.09
	41	T7	
	7.04	V 42	00.11.54
		V 39	00.12.49
		V 36	00.13.54
		V 33	00.15.24
	42	T7	
	7.36	V 42	00.12.21
		V 39	00.13.18
		V 36	00.14.26
		V 33	00.15.59
	43	T7	
	7.97	V 42	00.13.14
		V 39	00.14.15
		V 36	00.15.27
		V 33	00.17.06
	44	T7	

EQUIPE BICHO DO MATO		Pág: 009		
	8.07	V 42	00.13.22	
		V 39	00.14.24	
		V 36	00.15.37	
		V 33	00.17.16	
	45	T7		
	8.22			
	0.00			
		V 42	00.13.35	
		V 39	00.14.38	
		V 36	00.15.52	
		V 33	00.17.33	
	46	T8		
		0.35	V 42	00.14.05
			V 39	00.15.10
			V 36	00.16.27
		V 33	00.18.11	
47		T8		
	0.42	V 30	00.14.11	
		V 27	00.15.17	
		V 24	00.16.34	
		V 21	00.18.19	
	48	T9		
	0.51	V 30	00.14.22	
		V 27	00.15.29	
		V 24	00.16.48	
		V 21	00.18.34	
	49	T9		
				
	0.70	V 42	00.14.45	
		V 39	00.15.54	
		V 36	00.17.16	
		V 33	00.19.07	
	50	T10		

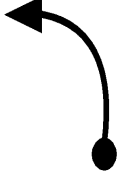
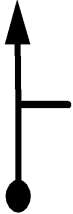
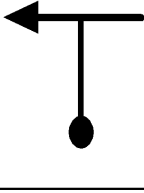
EQUIPE BICHO DO MATO		Pág: 010	
	0.84	V 42	00.14.57
		V 39	00.16.07
		V 36	00.17.30
		V 33	00.19.22
	51	T10	
	1.24	V 42	00.15.31
		V 39	00.16.44
		V 36	00.18.10
		V 33	00.20.06
	52	T10	
			
	1.29	V 42	00.15.35
		V 39	00.16.48
		V 36	00.18.15
		V 33	00.20.11
	53	T10	
	1.38	V 42	00.15.43
		V 39	00.16.57
		V 36	00.18.24
		V 33	00.20.21
	54	T10	
	1.53	V 42	00.15.56
		V 39	00.17.10
		V 36	00.18.39
		V 33	00.20.37
	55	T10	
			
	1.68	N 2'	00.16.09
		N 2'	00.17.24
		N 2'	00.18.54
		N 2'	00.20.54
	56	T11	

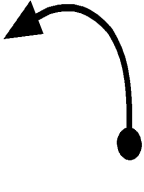
EQUIPE BICHO DO MATO		Pág: 011	
	1.68	V 42	00.18.09
		V 39	00.19.24
		V 36	00.20.54
		V 33	00.22.54
	57	T12	
	1.77	V 42	00.18.16
		V 39	00.19.33
		V 36	00.21.03
		V 33	00.23.03
	58	T12	
			
	1.80	V 51	00.18.19
		V 49	00.19.35
		V 46	00.21.06
		V 43	00.23.07
	59	T13	
			
	2.17	V 51	00.18.45
		V 48	00.20.03
		V 45	00.21.35
		V 42	00.23.38
	60	T14	
	2.28	V 36	00.18.53
		V 33	00.20.11
		V 30	00.21.44
		V 27	00.23.47
	61	T15	
	2.47	V 36	00.19.12
		V 33	00.20.32
		V 30	00.22.07
		V 27	00.24.12
	62	T15	

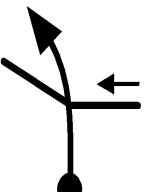
EQUIPE BICHO DO MATO		Pág: 012	
	2.66	V 39	00.19.31
		V 36	00.20.52
		V 33	00.22.30
		V 30	00.24.38
	63	T16	
	2.68	V 39	00.19.33
		V 36	00.20.54
		V 33	00.22.32
		V 30	00.24.40
	64	T16	
	2.78	V 39	00.19.42
		V 36	00.21.04
		V 33	00.22.43
		V 30	00.24.52
	65	T16	
	2.99	V 30	00.20.01
		V 27	00.21.25
		V 24	00.23.06
		V 21	00.25.17
	66	T17	
	3.16	V 30	00.20.22
		V 27	00.21.48
		V 24	00.23.31
		V 21	00.25.46
	67	T17	
	3.27	V 30	00.20.35
		V 27	00.22.03
		V 24	00.23.48
		V 21	00.26.05
	68	T17	
			
	3.34	V 30	00.20.43
		V 27	00.22.12
		V 24	00.23.58
		V 21	00.26.17
	69	T17	

EQUIPE BICHO DO MATO Pág: 013	
	3.52
	V 42 00.21.05
	V 39 00.22.36
	V 36 00.24.25
	V 33 00.26.48
70 T18	
	3.66
	V 42 00.21.17
	V 39 00.22.49
	V 36 00.24.39
	V 33 00.27.03
71 T18	
	4.06
	V 42 00.21.51
	V 39 00.23.26
	V 36 00.25.19
	V 33 00.27.47
72 T18	
	4.11
	V 42 00.21.55
	V 39 00.23.30
	V 36 00.25.24
	V 33 00.27.52
73 T18	
	4.20
	V 42 00.22.03
	V 39 00.23.39
	V 36 00.25.33
	V 33 00.28.02
74 T18	
	4.23
	V 36 00.22.06
	V 33 00.23.41
	V 30 00.25.36
	V 27 00.28.06
75 T19	
	4.35
	V 36 00.22.18
	V 33 00.23.55
	V 30 00.25.51
	V 27 00.28.22
76 T19	

EQUIPE BICHO DO MATO Pág: 014	
	4.44
	N 2' 00.22.27
	N 2' 00.24.04
	N 2' 00.26.01
	N 2' 00.28.34
77 T20	
	4.44
	V 51 00.24.27
	V 48 00.26.04
	V 45 00.28.01
	V 42 00.30.34
	78 T21
	4.92
	V 15 00.25.00
	V 15 00.26.40
	V 15 00.28.40
	V 12 00.31.15
	79 T22
	5.06
	V 15 00.25.34
	V 15 00.27.14
	V 15 00.29.13
	V 12 00.31.57
80 T22	
	5.12
	V 42 00.25.48
	V 39 00.27.28
	V 36 00.29.28
	V 33 00.32.15
81 T23	
	5.44
	V 42 00.26.16
	V 39 00.27.58
	V 36 00.30.00
	V 33 00.32.50
82 T23	
	5.47
	V 42 00.26.18
	V 39 00.28.01
	V 36 00.30.03
	V 33 00.32.53
83 T23	

EQUIPE BICHO DO MATO Pág: 015	
	5.80
	V 39 00.26.47
	V 36 00.28.31
	V 33 00.30.36
	V 30 00.33.29
84 T24	
	6.29
	V 39 00.27.32
	V 36 00.29.20
	V 33 00.31.29
	V 30 00.34.28
85 T24	
	6.41
	V 39 00.27.43
	V 36 00.29.32
	V 33 00.31.42
	V 30 00.34.42
86 T24	
ACELERE!!!	
	6.68
	V 39 00.28.08
	V 36 00.29.59
	V 33 00.32.12
	V 30 00.35.14
87 T24	
	6.82
	V 39 00.28.21
	V 36 00.30.13
	V 33 00.32.27
	V 30 00.35.31
88 T24	
	6.83
	V 39 00.28.22
	V 36 00.30.14
	V 33 00.32.28
	V 30 00.35.32
89 T24	
PERIGO	
	6.91
	V 39 00.28.29
	V 36 00.30.22
	V 33 00.32.37
	V 30 00.35.42
90 T24	

EQUIPE BICHO DO MATO		Pág: 016	
	7.05	V 39	00.28.42
		V 36	00.30.36
		V 33	00.32.52
		V 30	00.35.59
		91	T24
	7.07	V 39	00.28.44
		V 36	00.30.38
		V 33	00.32.54
		V 30	00.36.01
		92	T24
	7.22	V 39	00.28.58
		V 36	00.30.53
		V 33	00.33.11
		V 30	00.36.19
		93	T24
	7.26	V 39	00.29.02
		V 36	00.30.57
		V 33	00.33.15
		V 30	00.36.24
		94	T24
	7.29	V 39	00.29.04
		V 36	00.31.00
		V 33	00.33.18
		V 30	00.36.28
		95	T24
PERIGO NÃO ERRE			
	7.56	V 39	00.29.29
		V 36	00.31.27
		V 33	00.33.48
		V 30	00.37.00
		96	T24

EQUIPE BICHO DO MATO		Pág: 017	
	7.87	V 39	00.29.58
		V 36	00.31.58
		V 33	00.34.22
		V 30	00.37.37
		97	T24
	7.91	V 39	00.30.02
		V 36	00.32.02
		V 33	00.34.26
		V 30	00.37.42
		98	T24
	8.01	V 27	00.30.11
		V 24	00.32.12
		V 21	00.34.37
		V 18	00.37.54
		99	T25
	8.21	V 36	00.30.37
		V 33	00.32.42
		V 30	00.35.11
		V 27	00.38.34
		100	T26
	8.40	V 36	00.30.56
		V 33	00.33.03
		V 30	00.35.34
		V 27	00.38.59
		101	T26
	8.54	N 3'	00.31.10
		N 3'	00.33.18
		N 3'	00.35.51
		N 3'	00.39.18
		102	T27
	8.54	V 39	00.34.10
		V 36	00.36.18
		V 33	00.38.51
		V 30	00.42.18
		103	T28

EQUIPE BICHO DO MATO		Pág: 018	
	8.70	V 39	00.34.25
		V 36	00.36.34
		V 33	00.39.08
		V 30	00.42.37
		104	T28
PERIGO			
	9.03	V 39	00.34.56
		V 36	00.37.07
		V 33	00.39.44
		V 30	00.43.17
		105	T28
	9.34	V 39	00.35.24
		V 36	00.37.38
		V 33	00.40.18
		V 30	00.43.54
		106	T28
	9.48	V 39	00.35.37
		V 36	00.37.52
		V 33	00.40.33
		V 30	00.44.11
		107	T28
	9.76	V 39	00.36.03
		V 36	00.38.20
		V 33	00.41.04
		V 30	00.44.44
		108	T28
	9.88	N 1'	00.36.14
	0.00	N 1'	00.38.32
		N 1'	00.41.17
		N 1'	00.44.59
		109	T29

EQUIPE BICHO DO MATO		Pág: 019	
	0.00	V 39	00.37.14
		V 36	00.39.32
		V 33	00.42.17
		V 30	00.45.59
	110	T30	
		0.30	V 39
		V 36	00.40.02
		V 33	00.42.50
		V 30	00.46.35
111		T30	
	0.44	V 27	00.37.55
		V 24	00.40.16
		V 21	00.43.05
		V 18	00.46.52
	112	T31	
	0.64	V 36	00.38.21
		V 33	00.40.46
		V 30	00.43.39
		V 27	00.47.32
	113	T32	
	0.83	V 42	00.38.40
		V 39	00.41.07
		V 36	00.44.02
		V 33	00.47.57
	114	T33	
	0.85	V 42	00.38.42
		V 39	00.41.09
		V 36	00.44.04
		V 33	00.47.59
	115	T33	
	1.14	V 36	00.39.07
		V 33	00.41.35
		V 30	00.44.33
		V 27	00.48.31
	116	T34	





EQUIPE BICHO DO MATO		Pág: 020	
	1.48	V 36	00.39.41
		V 33	00.42.13
		V 30	00.45.14
		V 27	00.49.16
	117	T34	
		1.88	V 36
		V 33	00.42.56
		V 30	00.46.02
		V 27	00.50.09
118		T34	
	1.96	N1'30s	00.40.29
		N1'30s	00.43.05
		N1'30s	00.46.12
		N1'30s	00.50.20
	119	T35	
	1.96	V 42	00.41.59
		V 39	00.44.35
		V 36	00.47.42
		V 33	00.51.50
	120	T36	
	3.10	V 42	00.43.37
		V 39	00.46.20
		V 36	00.49.36
		V 33	00.53.55
	121	T36	
	3.94	V 42	00.44.49
		V 39	00.47.38
		V 36	00.51.00
		V 33	00.55.26
	122	T36	



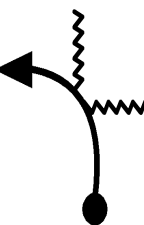

EQUIPE BICHO DO MATO		Pág: 021	
	4.08	V 42	00.45.01
		V 39	00.47.51
		V 36	00.51.14
		V 33	00.55.41
	123	T36	
		4.09	V 42
		V 39	00.47.52
		V 36	00.51.15
		V 33	00.55.43
124		T36	
	4.10	V 42	00.45.02
		V 39	00.47.52
		V 36	00.51.16
		V 33	00.55.44
	125	T36	
	4.48	V 24	00.45.35
		V 21	00.48.28
		V 18	00.51.54
		V 15	00.56.25
	126	T37	
	5.08	V 24	00.47.05
		V 21	00.50.10
		V 18	00.53.54
		V 15	00.58.49
	127	T37	
	5.87	V 24	00.49.03
		V 21	00.52.26
		V 18	00.56.32
		V 15	01.01.59
	128	T37	
	5.98	V 24	00.49.20
		V 21	00.52.45
		V 18	00.56.54
		V 15	01.02.25
	129	T37	



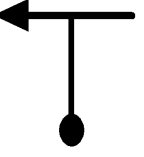
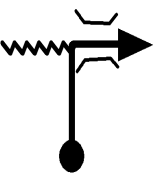

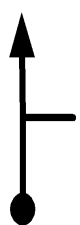
EQUIPE BICHO DO MATO		Pág: 022	
	6.07	N 3'	00.49.33
		N 3'	00.53.00
		N 3'	00.57.12
		N 3'	01.02.47
	130	T38	
	6.07	V 24	00.52.33
		V 21	00.56.00
		V 18	01.00.12
		V 15	01.05.47
	131	T39	
	6.13	V 21	00.52.42
		V 18	00.56.10
		V 15	01.00.24
		V 12	01.06.01
	132	T40	
	6.38	V 21	00.53.25
		V 18	00.57.00
		V 15	01.01.24
		V 12	01.07.16
	133	T40	
	6.58	V 21	00.54.00
		V 18	00.57.40
		V 15	01.02.12
		V 12	01.08.16
	134	T40	
	6.94	V 39	00.55.01
		V 36	00.58.52
		V 33	01.03.38
		V 30	01.10.04
	135	T41	
	6.95	V 39	00.55.02
		V 36	00.58.53
		V 33	01.03.39
		V 30	01.10.05
	136	T41	

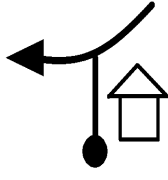
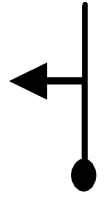
EQUIPE BICHO DO MATO		Pág: 023	
	6.97	V 39	00.55.04
		V 36	00.58.55
		V 33	01.03.41
		V 30	01.10.08
	137	T41	
	7.05	V 39	00.55.11
		V 36	00.59.03
		V 33	01.03.50
		V 30	01.10.17
	138	T41	
	8.12	V 54	00.56.50
	0.00	V 51	01.00.50
		V 48	01.05.47
		V 45	01.12.26
	139	T42	
	0.28	V 54	00.57.09
		V 51	01.01.10
		V 48	01.06.08
		V 45	01.12.48
	140	T42	
	0.86	V 45	00.57.48
		V 42	01.01.51
		V 39	01.06.51
		V 36	01.13.34
	141	T43	
	1.85	V 39	00.59.07
		V 36	01.03.16
		V 33	01.08.23
		V 30	01.15.13
	142	T44	

EQUIPE BICHO DO MATO		Pág: 024	
	1.93	V 39	00.59.14
		V 36	01.03.24
		V 33	01.08.31
		V 30	01.15.23
	143	T44	
	2.05	V 39	00.59.25
		V 36	01.03.36
		V 33	01.08.44
		V 30	01.15.37
	144	T44	
	2.40	V 39	00.59.58
		V 36	01.04.11
		V 33	01.09.23
		V 30	01.16.19
	145	T44	
	2.49	V 39	01.00.06
		V 36	01.04.20
		V 33	01.09.32
		V 30	01.16.30
	146	T44	
	2.56	V 33	01.00.12
		V 30	01.04.27
		V 27	01.09.40
		V 24	01.16.39
	147	T45	
PEDRA LISA			
	2.69	V 33	01.00.26
		V 30	01.04.43
		V 27	01.09.57
		V 24	01.16.58
	148	T45	

EQUIPE BICHO DO MATO		Pág: 025	
	2.74	V 27	01.00.32
		V 24	01.04.49
		V 21	01.10.04
		V 18	01.17.06
	149	T46	
	3.13	V 27	01.01.24
		V 24	01.05.47
		V 21	01.11.11
		V 18	01.18.24
	150	T46	
	3.31	V 39	01.01.48
		V 36	01.06.14
		V 33	01.11.42
		V 30	01.19.00
	151	T47	
	3.41	V 39	01.01.57
		V 36	01.06.24
		V 33	01.11.53
		V 30	01.19.12
	152	T47	
	3.50	V 39	01.02.05
		V 36	01.06.33
		V 33	01.12.02
		V 30	01.19.22
	153	T47	
	3.82	V 39	01.02.35
		V 36	01.07.05
		V 33	01.12.37
		V 30	01.20.01
	154	T47	
	4.05	V 39	01.02.56
		V 36	01.07.28
		V 33	01.13.02
		V 30	01.20.28
	155	T47	

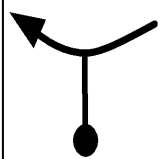

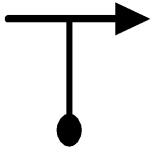
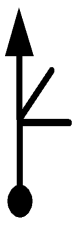



EQUIPE BICHO DO MATO		Pág: 026	
	4.15	V 39	01.03.05
		V 36	01.07.38
		V 33	01.13.13
		V 30	01.20.40
	156	T47	
	4.19	V 39	01.03.09
		V 36	01.07.42
		V 33	01.13.18
		V 30	01.20.45
	157	T47	
	4.23	V 39	01.03.13
		V 36	01.07.46
		V 33	01.13.22
		V 30	01.20.50
	158	T47	
	4.29	V 39	01.03.18
		V 36	01.07.52
		V 33	01.13.29
		V 30	01.20.57
	159	T47	
	4.58	V 39	01.03.45
		V 36	01.08.21
		V 33	01.14.00
		V 30	01.21.32
	160	T47	
	4.65	V 39	01.03.52
		V 36	01.08.28
		V 33	01.14.08
		V 30	01.21.40
	161	T47	
	4.92	V 39	01.04.17
		V 36	01.08.55
		V 33	01.14.37
		V 30	01.22.13
	162	T47	





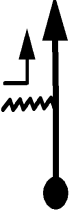
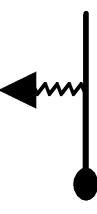

EQUIPE BICHO DO MATO		Pág: 027	
	4.94	V 39	01.04.18
		V 36	01.08.57
		V 33	01.14.39
		V 30	01.22.15
	163	T47	
	5.04	V 18	01.04.28
		V 15	01.09.07
		V 12	01.14.50
		V 9	01.22.27
	164	T48	
	5.32	V 18	01.05.24
		V 15	01.10.14
		V 12	01.16.14
		V 9	01.24.19
	165	T48	
	5.48	N 2'	01.05.56
		N 2'	01.10.53
		N 2'	01.17.02
		N 2'	01.25.23
	166	T49	
	5.48	V 39	01.07.56
		V 36	01.12.53
		V 33	01.19.02
		V 30	01.27.23
	167	T50	
	5.78	V 39	01.08.23
		V 36	01.13.23
		V 33	01.19.35
		V 30	01.27.59
	168	T50	
	6.26	V 39	01.09.08
		V 36	01.14.11
		V 33	01.20.27
		V 30	01.28.57
	169	T50	

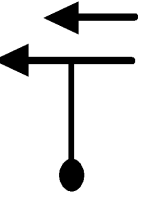

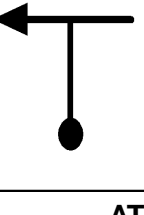

EQUIPE BICHO DO MATO		Pág: 028	
	6.42	V 39	01.09.22
		V 36	01.14.27
		V 33	01.20.45
		V 30	01.29.16
	170	T50	
	7.09	V 39	01.10.24
		V 36	01.15.34
		V 33	01.21.58
		V 30	01.30.36
	171	T50	
	7.24	V 39	01.10.38
		V 36	01.15.49
		V 33	01.22.14
		V 30	01.30.54
	172	T50	
	7.45	V 30	01.10.57
		V 27	01.16.10
		V 24	01.22.37
		V 21	01.31.20
	173	T51	
	7.53	V 30	01.11.07
		V 27	01.16.20
		V 24	01.22.49
		V 21	01.31.33
	174	T51	
	7.58	V 30	01.11.13
		V 27	01.16.27
		V 24	01.22.57
		V 21	01.31.42
	175	T51	
	7.66	N 1'	01.11.23
		N 1'	01.16.38
		N 1'	01.23.09
		N 1'	01.31.56
	176	T52	

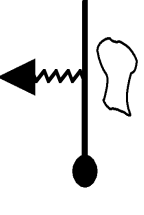
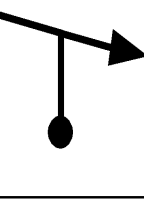
EQUIPE BICHO DO MATO		Pág: 029	
	7.66	V 15	01.12.23
		V 15	01.17.38
		V 15	01.24.09
		V 12	01.32.56
	177	T53	
	7.85	V 39	01.13.08
		V 36	01.18.23
		V 33	01.24.54
		V 30	01.33.53
	178	T54	
	7.94	V 39	01.13.17
		V 36	01.18.32
		V 33	01.25.04
		V 30	01.34.03
	179	T54	
	8.44	V 39	01.14.03
		V 36	01.19.22
		V 33	01.25.59
		V 30	01.35.03
	180	T54	
	8.69	V 39	01.14.26
		V 36	01.19.47
		V 33	01.26.26
		V 30	01.35.33
	181	T54	
	8.77	V 39	01.14.33
		V 36	01.19.55
		V 33	01.26.35
		V 30	01.35.43
	182	T54	

EQUIPE BICHO DO MATO		Pág: 030	
	8.89		
	0.00		
		N 20'	01.14.44
		N 18'	01.20.07
		N 15'	01.26.48
	N 15'	01.35.57	
183	T55		
	0.00		
		V 33	01.34.44
		V 33	01.38.07
		V 33	01.41.48
		V 30	01.50.57
184	T56		
	0.59		
		V 15	01.35.49
		V 15	01.39.12
		V 15	01.42.52
		V 12	01.52.08
185	T57		
	0.70		
		V 15	01.36.15
		V 15	01.39.38
		V 15	01.43.19
		V 12	01.52.41
186	T57		
	0.74		
		V 33	01.36.25
		V 30	01.39.48
		V 27	01.43.28
		V 24	01.52.53
187	T58		
	0.84		
		V 33	01.36.36
		V 30	01.40.00
		V 27	01.43.42
		V 24	01.53.08
188	T58		

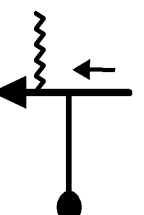
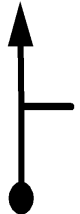
EQUIPE BICHO DO MATO		Pág: 031	
	0.92	V 33	01.36.44
		V 30	01.40.09
		V 27	01.43.52
		V 24	01.53.20
	189	T58	
	0.99	V 33	01.36.52
		V 30	01.40.18
		V 27	01.44.02
		V 24	01.53.31
	190	T58	
	1.04	V 33	01.36.57
		V 30	01.40.24
		V 27	01.44.08
		V 24	01.53.38
	191	T58	
			
	1.17	V 33	01.37.12
		V 30	01.40.39
		V 27	01.44.26
		V 24	01.53.58
	192	T58	
	1.40	V 18	01.37.37
		V 15	01.41.07
		V 12	01.44.56
		V 9	01.54.32
	193	T59	
			
	1.65	V 33	01.38.27
		V 30	01.42.07
		V 27	01.46.11
		V 24	01.56.12
	194	T60	

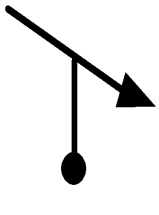
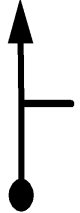
EQUIPE BICHO DO MATO		Pág: 032	
	1.88	V 33	01.38.52
		V 30	01.42.34
		V 27	01.46.42
		V 24	01.56.47
	195	T60	
	1.92	V 18	01.38.56
		V 15	01.42.39
		V 12	01.46.47
		V 9	01.56.53
	196	T61	
	1.99	V 33	01.39.10
		V 30	01.42.56
		V 27	01.47.08
		V 24	01.57.21
	197	T62	
ATOLEIRO			
PELA ESQUERDA			
			
	2.45	V 33	01.40.00
		V 30	01.43.51
		V 27	01.48.10
		V 24	01.58.30
	198	T62	
	2.48	V 33	01.40.04
		V 30	01.43.55
		V 27	01.48.14
		V 24	01.58.34
	199	T62	
	2.56	V 33	01.40.12
		V 30	01.44.04
		V 27	01.48.24
		V 24	01.58.46
	200	T62	

EQUIPE BICHO DO MATO		Pág: 033	
			
	2.68	V 42	01.40.25
		V 39	01.44.19
		V 36	01.48.40
		V 33	01.59.04
	201	T63	
	2.73	V 42	01.40.30
		V 39	01.44.23
		V 36	01.48.45
		V 33	01.59.10
	202	T63	
	2.80	V 42	01.40.36
		V 39	01.44.30
		V 36	01.48.52
		V 33	01.59.17
	203	T63	
	2.86	V 42	01.40.41
		V 39	01.44.35
		V 36	01.48.58
		V 33	01.59.24
	204	T63	
	2.97	V 42	01.40.50
		V 39	01.44.46
		V 36	01.49.09
		V 33	01.59.36
	205	T63	
			
	3.01	V 42	01.40.54
		V 39	01.44.49
		V 36	01.49.13
		V 33	01.59.40
	206	T63	

EQUIPE BICHO DO MATO Pág: 034	
	3.39
	V 36 01.41.26
	V 33 01.45.24
	V 30 01.49.51
	V 27 02.00.22
207 T64	
	3.92
	V 27 01.42.19
	V 24 01.46.22
	V 21 01.50.55
	V 18 02.01.32
208 T65	
CUIDADO DESCE	
	4.00
	V 27 01.42.30
	V 24 01.46.34
	V 21 01.51.09
	V 18 02.01.48
	209 T65
	4.09
	V 27 01.42.42
	V 24 01.46.48
	V 21 01.51.24
	V 18 02.02.06
210 T65	
BAMP	
	4.11
	V 18 01.42.45
	V 15 01.46.51
	V 12 01.51.27
	V 9 02.02.10
211 T66	
	4.30
	V 42 01.43.23
	V 39 01.47.36
	V 36 01.52.24
	V 33 02.03.26
212 T67	

EQUIPE BICHO DO MATO Pág: 035	
	4.69
	V 42 01.43.56
	V 39 01.48.12
	V 36 01.53.03
	V 33 02.04.09
213 T67	
	4.73
	V 42 01.43.59
	V 39 01.48.16
	V 36 01.53.07
	V 33 02.04.13
214 T67	
BAMP	
	4.80
	D 3' 01.44.05
	D 3' 01.48.22
	D 3' 01.53.14
	D 3' 02.04.21
215 T68	
	4.99
	216 T68
	5.04
	V 48 01.47.05
	V 45 01.51.22
	V 42 01.56.14
	V 39 02.07.21
217 T69	
BAMP	
	5.31
	V 48 01.47.26
	V 45 01.51.44
	V 42 01.56.38
	V 39 02.07.46
218 T69	

EQUIPE BICHO DO MATO Pág: 036	
	5.34
	V 48 01.47.28
	V 45 01.51.46
	V 42 01.56.40
	V 39 02.07.49
219 T69	
	5.47
	V 48 01.47.38
	V 45 01.51.57
	V 42 01.56.51
	V 39 02.08.01
220 T69	
BAMP	
	5.53
	V 36 01.47.42
	V 33 01.52.02
	V 30 01.56.56
	V 27 02.08.06
221 T70	
ENTRE NO MATO	
	5.57
	V 36 01.47.46
	V 33 01.52.06
	V 30 01.57.01
	V 27 02.08.11
222 T70	
PELA ESQUERDA	
	5.81
	V 36 01.48.10
	V 33 01.52.32
	V 30 01.57.30
	V 27 02.08.43
223 T70	
	6.04
	V 36 01.48.33
	V 33 01.52.57
	V 30 01.57.58
	V 27 02.09.14
224 T70	

EQUIPE BICHO DO MATO		Pág: 037	
	6.11	V 36	01.48.40
		V 33	01.53.05
		V 30	01.58.06
		V 27	02.09.23
		225	T70
		6.13	V 36
		V 33	01.53.07
		V 30	01.58.08
		V 27	02.09.26
		226	T70
		6.31	V 36
		V 33	01.53.27
		V 30	01.58.30
		V 27	02.09.50
		227	T70
		6.38	V 36
		V 33	01.53.34
		V 30	01.58.38
		V 27	02.09.59
		228	T70
		6.48	V 36
		V 33	01.53.45
		V 30	01.58.50
		V 27	02.10.13
		229	T70
		6.55	V 42
		V 39	01.53.53
		V 36	01.58.59
		V 33	02.10.22
		230	T71
		6.86	V 42
		V 39	01.54.21
		V 36	01.59.30
		V 33	02.10.56
		231	T71

EQUIPE BICHO DO MATO		Pág: 038	
	7.00	V 42	01.50.03
		V 39	01.54.34
		V 36	01.59.44
		V 33	02.11.11
		232	T71
	7.15	V 42	01.50.16
		V 39	01.54.48
		V 36	01.59.59
		V 33	02.11.28
		233	T71
		7.30	V 42
		V 39	01.55.02
		V 36	02.00.14
		V 33	02.11.44
		234	T71
		7.45	V 42
		V 39	01.55.16
		V 36	02.00.29
		V 33	02.12.00
		235	T71
	CUIDADO		
CUIDADO			
	7.47	V 21	01.50.43
		V 18	01.55.18
		V 15	02.00.31
		V 12	02.12.02
		236	T72
		7.69	V 42
		V 39	01.56.02
		V 36	02.01.24
		V 33	02.13.08
		237	T73

EQUIPE BICHO DO MATO		Pág: 039	
	7.82	V 42	01.51.32
		V 39	01.56.14
		V 36	02.01.37
		V 33	02.13.23
		238	T73
	7.96	V 42	01.51.44
		V 39	01.56.27
		V 36	02.01.51
		V 33	02.13.38
		239	T73
	7.99	V 42	01.51.46
		V 39	01.56.29
		V 36	02.01.54
		V 33	02.13.41
		240	T73
		8.03	V 42
		V 39	01.56.33
		V 36	02.01.58
		V 33	02.13.46
		241	T73
		9.12	
	0.00		
		V 36	01.53.23
		V 33	01.58.14
		V 30	02.03.47
		V 27	02.15.44
	242	T74	

EQUIPE BICHO DO MATO		Pág: 040	
	0.41	V 36	01.54.04
		V 33	01.58.58
		V 30	02.04.36
		V 27	02.16.39
	243	T74	
	0.64	V 36	01.54.27
		V 33	01.59.24
		V 30	02.05.03
		V 27	02.17.10
	244	T74	
	1.24	V 36	01.55.27
		V 33	02.00.29
		V 30	02.06.15
		V 27	02.18.30
	245	T74	
☠☠			
	1.50	V 42	01.55.53
		V 39	02.00.57
		V 36	02.06.47
		V 33	02.19.04
	246	T75	
	1.53	V 42	01.55.56
		V 39	02.01.00
		V 36	02.06.50
		V 33	02.19.08
	247	T75	
CUIDADO			
CUIDADO			
☠☠☠			
	1.89	V 21	01.56.27
		V 18	02.01.33
		V 15	02.07.26
		V 12	02.19.47
	248	T76	

EQUIPE BICHO DO MATO		Pág: 041	
	2.10	V 42	01.57.03
		V 39	02.02.15
		V 36	02.08.16
		V 33	02.20.50
	249	T77	
	2.37	V 42	01.57.26
		V 39	02.02.40
		V 36	02.08.43
		V 33	02.21.19
	250	T77	
	2.40	V 42	01.57.28
		V 39	02.02.43
		V 36	02.08.46
		V 33	02.21.23
	251	T77	
	2.44	V 42	01.57.32
		V 39	02.02.47
		V 36	02.08.50
		V 33	02.21.27
	252	T77	
	3.01	V 42	01.58.21
		V 39	02.03.39
		V 36	02.09.47
		V 33	02.22.29
	253	T77	
	3.32	V 42	01.58.47
		V 39	02.04.08
		V 36	02.10.18
		V 33	02.23.03
	254	T77	
	3.47	V 42	01.59.00
		V 39	02.04.22
		V 36	02.10.33
		V 33	02.23.19
	255	T77	

EQUIPE BICHO DO MATO		Pág: 042	
COSTEAR			
ASFALTO			
	4.06	D 3'	01.59.51
		D 3'	02.05.16
		D 3'	02.11.32
		D 3'	02.24.24
	256	T78	
	4.17		
	257	T78	
	4.34	V 36	02.02.51
		V 33	02.08.16
		V 30	02.14.32
		V 27	02.27.24
	258	T79	
VALO			
☠			
	4.37	V 36	02.02.54
		V 33	02.08.20
		V 30	02.14.36
		V 27	02.27.28
	259	T79	
☠☠			
	4.40	V 36	02.02.57
		V 33	02.08.23
		V 30	02.14.39
		V 27	02.27.32
	260	T79	
	4.57	V 36	02.03.14
		V 33	02.08.41
		V 30	02.15.00
		V 27	02.27.55
	261	T79	

EQUIPE BICHO DO MATO		Pág: 043	
	4.61	V 36	02.03.18
		V 33	02.08.46
		V 30	02.15.04
		V 27	02.28.00
		262	T79
	4.64	V 36	02.03.21
		V 33	02.08.49
		V 30	02.15.08
		V 27	02.28.04
		263	T79
	4.68	V 36	02.03.25
		V 33	02.08.53
		V 30	02.15.13
		V 27	02.28.09
		264	T79
	4.84	V 36	02.03.41
		V 33	02.09.11
		V 30	02.15.32
		V 27	02.28.31
		265	T79
	5.04	V 36	02.04.01
		V 33	02.09.33
		V 30	02.15.56
		V 27	02.28.57
		266	T79
	5.08	V 36	02.04.05
		V 33	02.09.37
		V 30	02.16.01
		V 27	02.29.03
		267	T79
	5.12	V 42	02.04.09
		V 39	02.09.41
		V 36	02.16.06
		V 33	02.29.08
		268	T80









EQUIPE BICHO DO MATO		Pág: 044	
	5.32	V 42	02.04.26
		V 39	02.10.00
		V 36	02.16.26
		V 33	02.29.30
		269	T80
	5.46	V 42	02.04.38
		V 39	02.10.13
		V 36	02.16.40
		V 33	02.29.45
		270	T80
	5.61	V 42	02.04.51
		V 39	02.10.27
		V 36	02.16.55
		V 33	02.30.01
		271	T80
CUIDADO			
CUIDADO			
	5.64	V 21	02.04.53
		V 18	02.10.29
		V 15	02.16.58
		V 12	02.30.05
		272	T81
	5.86	V 42	02.05.31
		V 39	02.11.13
		V 36	02.17.50
		V 33	02.31.11
		273	T82
	5.99	V 42	02.05.42
		V 39	02.11.25
		V 36	02.18.03
		V 33	02.31.25
		274	T82



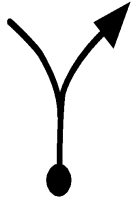

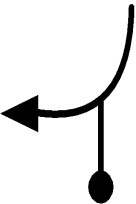

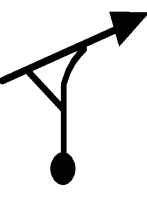
EQUIPE BICHO DO MATO		Pág: 045	
	6.13	V 42	02.05.54
		V 39	02.11.38
		V 36	02.18.17
		V 33	02.31.40
		275	T82
	6.16	V 42	02.05.57
		V 39	02.11.41
		V 36	02.18.20
		V 33	02.31.43
		276	T82
	6.20	V 42	02.06.00
		V 39	02.11.45
		V 36	02.18.24
		V 33	02.31.48
		277	T82
	6.76	V 42	02.06.48
		V 39	02.12.36
		V 36	02.19.20
		V 33	02.32.49
		278	T82
	7.08	V 42	02.07.16
		V 39	02.13.06
		V 36	02.19.52
		V 33	02.33.24
		279	T82
	7.22	V 42	02.07.28
		V 39	02.13.19
		V 36	02.20.06
		V 33	02.33.39
		280	T82
	7.50	N 2'	02.07.52
		N 2'	02.13.45
		N 2'	02.20.34
		N 2'	02.34.09
		281	T83





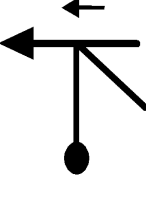

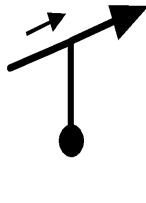

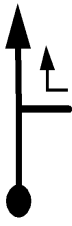
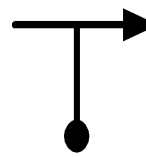
EQUIPE BICHO DO MATO		Pág: 046	
	7.50	V 27	02.09.52
		V 24	02.15.45
		V 21	02.22.34
		V 18	02.36.09
	282	T84	
	7.80	V 27	02.10.32
		V 24	02.16.30
		V 21	02.23.26
		V 18	02.37.09
	283	T84	
	8.68	V 27	02.12.29
		V 24	02.18.42
		V 21	02.25.57
		V 18	02.40.05
	284	T84	
	8.74	D 5'	02.12.37
		D 5'	02.18.51
		D 5'	02.26.07
		D 5'	02.40.17
	285	T85	
	9.14		
	286	T85	
	9.71		
	287	T85	
	9.75		
	0.00	V 15	02.17.37
		V 15	02.23.51
		V 15	02.31.07
		V 12	02.45.17
	288	T86	

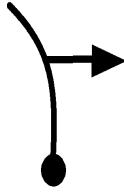
EQUIPE BICHO DO MATO		Pág: 047	
	0.05	V 15	02.17.49
		V 15	02.24.03
		V 15	02.31.19
		V 12	02.45.32
	289	T86	
	0.10	V 15	02.18.01
		V 15	02.24.15
		V 15	02.31.31
		V 12	02.45.47
	290	T86	
AÇUDE			
	0.12	V 39	02.18.06
		V 36	02.24.20
		V 33	02.31.36
		V 30	02.45.53
	291	T87	
	0.23	V 39	02.18.16
		V 36	02.24.31
		V 33	02.31.48
		V 30	02.46.07
	292	T87	
	0.78	V 39	02.19.07
		V 36	02.25.26
		V 33	02.32.48
		V 30	02.47.13
	293	T87	
	0.82	V 39	02.19.10
		V 36	02.25.30
		V 33	02.32.52
		V 30	02.47.17
	294	T87	

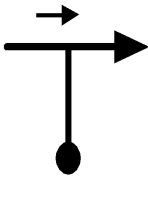
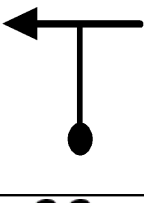
EQUIPE BICHO DO MATO		Pág: 048	
	0.91	V 39	02.19.19
		V 36	02.25.39
		V 33	02.33.02
		V 30	02.47.28
	295	T87	
	1.22	V 39	02.19.47
		V 36	02.26.10
		V 33	02.33.36
		V 30	02.48.05
	296	T87	
	1.49	V 39	02.20.12
		V 36	02.26.37
		V 33	02.34.05
		V 30	02.48.38
	297	T87	
	1.64	V 39	02.20.26
		V 36	02.26.52
		V 33	02.34.22
		V 30	02.48.56
	298	T87	
	1.76	V 24	02.20.37
		V 21	02.27.04
		V 18	02.34.35
		V 15	02.49.10
	299	T88	
	1.96	N 1'	02.21.07
		N 1'	02.27.38
		N 1'	02.35.15
		N 1'	02.49.58
	300	T89	

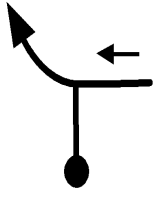
EQUIPE BICHO DO MATO		Pág: 049	
			
	1.96		
	V 39	02.22.07	
	V 36	02.28.38	
	V 33	02.36.15	
	V 30	02.50.58	
	301	T90	
	1.99		
	V 39	02.22.10	
	V 36	02.28.41	
	V 33	02.36.18	
	V 30	02.51.02	
	302	T90	
	2.09		
	V 39	02.22.19	
	V 36	02.28.51	
	V 33	02.36.29	
	V 30	02.51.14	
	303	T90	
	2.40		
	V 39	02.22.48	
	V 36	02.29.22	
	V 33	02.37.03	
	V 30	02.51.51	
	304	T90	
	2.66		
	V 39	02.23.12	
	V 36	02.29.48	
	V 33	02.37.31	
	V 30	02.52.22	
	305	T90	
	2.81		
	V 39	02.23.25	
	V 36	02.30.03	
	V 33	02.37.47	
	V 30	02.52.40	
	306	T90	
			
	2.88		
	V 33	02.23.32	
	V 30	02.30.10	
	V 27	02.37.55	
	V 24	02.52.49	
	307	T91	





EQUIPE BICHO DO MATO		Pág: 050	
	3.01		
	V 33	02.23.46	
	V 30	02.30.25	
	V 27	02.38.12	
	V 24	02.53.08	
	308	T91	
			
	3.23		
	V 33	02.24.10	
	V 30	02.30.52	
	V 27	02.38.42	
	V 24	02.53.41	
	309	T91	
			
	3.33		
	V 33	02.24.21	
	V 30	02.31.04	
	V 27	02.38.55	
	V 24	02.53.56	
	310	T91	
	3.47		
	V 33	02.24.36	
	V 30	02.31.21	
	V 27	02.39.14	
	V 24	02.54.17	
	311	T91	
			
	3.62		
	V 33	02.24.53	
	V 30	02.31.39	
	V 27	02.39.34	
	V 24	02.54.40	
	312	T91	
	3.65		
	V 33	02.24.56	
	V 30	02.31.42	
	V 27	02.39.38	
	V 24	02.54.44	
	313	T91	





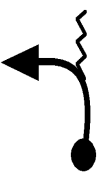
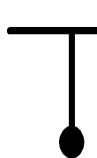

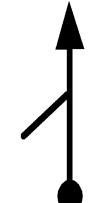
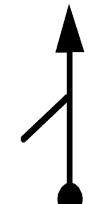

EQUIPE BICHO DO MATO		Pág: 051	
	3.82		
	V 33	02.25.14	
	V 30	02.32.03	
	V 27	02.40.00	
	V 24	02.55.10	
	314	T91	
			
	3.96		
	V 33	02.25.30	
	V 30	02.32.19	
	V 27	02.40.19	
	V 24	02.55.31	
	315	T91	
	3.99		
	V 33	02.25.33	
	V 30	02.32.23	
	V 27	02.40.23	
	V 24	02.55.35	
	316	T91	
			
	4.06		
	V 33	02.25.41	
	V 30	02.32.31	
	V 27	02.40.32	
	V 24	02.55.46	
	317	T91	
	4.20		
	V 33	02.25.56	
	V 30	02.32.48	
	V 27	02.40.51	
	V 24	02.56.07	
	318	T91	
			
	4.36		
	V 33	02.26.13	
	V 30	02.33.07	
	V 27	02.41.12	
	V 24	02.56.31	
	319	T91	

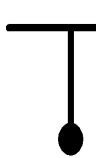







EQUIPE BICHO DO MATO		Pág: 052	
	4.39		
	V 33	02.26.17	
	V 30	02.33.11	
	V 27	02.41.16	
	V 24	02.56.35	
320	T91		
	4.56		
	N 2'	02.26.35	
	N 2'	02.33.31	
	N 2'	02.41.39	
	N 2'	02.57.01	
321	T92		
	4.56		
	V 36	02.28.35	
	V 33	02.35.31	
	V 30	02.43.39	
	V 27	02.59.01	
322	T93		
	4.67		
	V 36	02.28.46	
	V 33	02.35.43	
	V 30	02.43.52	
	V 27	02.59.15	
323	T93		
	4.94		
	V 36	02.29.13	
	V 33	02.36.13	
	V 30	02.44.25	
	V 27	02.59.51	
324	T93		
	4.96		
	V 36	02.29.15	
	V 33	02.36.15	
	V 30	02.44.27	
	V 27	02.59.54	
325	T93		
	5.09		
	V 24	02.29.28	
	V 21	02.36.29	
	V 18	02.44.43	
	V 15	03.00.11	
326	T94		

EQUIPE BICHO DO MATO		Pág: 053	
	5.31		
	V 33	02.30.01	
	V 30	02.37.07	
	V 27	02.45.27	
	V 24	03.01.04	
327	T95		
	5.36		
	V 33	02.30.07	
	V 30	02.37.13	
	V 27	02.45.33	
	V 24	03.01.12	
328	T95		
	5.37		
	V 33	02.30.08	
	V 30	02.37.14	
	V 27	02.45.35	
	V 24	03.01.13	
329	T95		
	5.47		
	V 24	02.30.19	
	V 21	02.37.26	
	V 18	02.45.48	
	V 15	03.01.28	
330	T96		
	5.62		
	V 33	02.30.41	
	V 30	02.37.52	
	V 27	02.46.18	
	V 24	03.02.04	
331	T97		
	5.97		
	V 33	02.31.19	
	V 30	02.38.34	
	V 27	02.47.05	
	V 24	03.02.57	
332	T97		

EQUIPE BICHO DO MATO		Pág: 054	
	6.02		
	V 33	02.31.25	
	V 30	02.38.40	
	V 27	02.47.11	
	V 24	03.03.04	
333	T97		
	6.18		
	V 33	02.31.42	
	V 30	02.38.59	
	V 27	02.47.33	
	V 24	03.03.28	
334	T97		
	6.28		
	V 33	02.31.53	
	V 30	02.39.11	
	V 27	02.47.46	
	V 24	03.03.43	
335	T97		
	6.34		
	V 33	02.32.00	
	V 30	02.39.18	
	V 27	02.47.54	
	V 24	03.03.52	
336	T97		
	6.50		
	V 33	02.32.17	
	V 30	02.39.38	
	V 27	02.48.15	
	V 24	03.04.16	
337	T97		
	6.55		
	V 33	02.32.23	
	V 30	02.39.44	
	V 27	02.48.22	
	V 24	03.04.24	
338	T97		

EQUIPE BICHO DO MATO		Pág: 055	
	6.68	V 33	02.32.37
		V 30	02.39.59
		V 27	02.48.39
		V 24	03.04.43
	339	T97	
	6.73	V 33	02.32.42
		V 30	02.40.05
		V 27	02.48.46
		V 24	03.04.51
	340	T97	
			
	6.93	V 33	02.33.04
		V 30	02.40.29
		V 27	02.49.13
		V 24	03.05.21
	341	T97	
			
	7.03	V 33	02.33.15
		V 30	02.40.41
		V 27	02.49.26
		V 24	03.05.36
	342	T97	
	7.08	V 33	02.33.20
		V 30	02.40.47
		V 27	02.49.33
		V 24	03.05.43
	343	T97	
	7.13	V 33	02.33.26
		V 30	02.40.53
		V 27	02.49.39
		V 24	03.05.51
	344	T97	

EQUIPE BICHO DO MATO		Pág: 056	
	7.16	V 33	02.33.29
		V 30	02.40.57
		V 27	02.49.43
		V 24	03.05.55
	345	T97	
			
	7.25	V 33	02.33.39
		V 30	02.41.08
		V 27	02.49.55
		V 24	03.06.09
	346	T97	
	7.28	V 27	02.33.42
		V 24	02.41.11
		V 21	02.49.59
		V 18	03.06.13
	347	T98	
	7.73	V 27	02.34.42
		V 24	02.42.19
		V 21	02.51.16
		V 18	03.07.43
	348	T98	
			
	7.77	V 33	02.34.48
		V 30	02.42.25
		V 27	02.51.23
		V 24	03.07.51
	349	T99	
			
	7.82	V 33	02.34.53
		V 30	02.42.31
		V 27	02.51.30
		V 24	03.07.59
	350	T99	

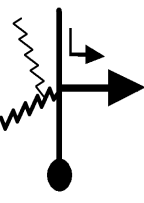
EQUIPE BICHO DO MATO		Pág: 057	
	7.98	V 33	02.35.10
		V 30	02.42.50
		V 27	02.51.51
		V 24	03.08.23
	351	T99	
	8.03	N 2'	02.35.16
		N 2'	02.42.56
		N 2'	02.51.58
		N 2'	03.08.30
	352	T100	
	8.03	V 33	02.37.16
		V 30	02.44.56
		V 27	02.53.58
		V 24	03.10.30
	353	T101	
			
	8.12	V 33	02.37.26
		V 30	02.45.07
		V 27	02.54.10
		V 24	03.10.44
	354	T101	
			
	8.21	V 33	02.37.36
		V 30	02.45.17
		V 27	02.54.22
		V 24	03.10.57
	355	T101	
			
	8.24	V 33	02.37.39
		V 30	02.45.21
		V 27	02.54.26
		V 24	03.11.02
	356	T101	

EQUIPE BICHO DO MATO		Pág: 058	
	8.56	V 33	02.38.14
		V 30	02.45.59
		V 27	02.55.09
		V 24	03.11.50
		357	T101
☠☠☠☠			
	9.01	V 21	02.39.03
		V 18	02.46.53
		V 15	02.56.09
		V 12	03.12.57
		358	T102
	9.20		
	0.00	V 39	02.39.35
		V 36	02.47.31
		V 33	02.56.54
		V 30	03.13.54
	359	T103	
	0.61	V 39	02.40.32
		V 36	02.48.32
		V 33	02.58.01
		V 30	03.15.07
		360	T103
	0.69	V 39	02.40.39
		V 36	02.48.40
		V 33	02.58.09
		V 30	03.15.17
		361	T103

EQUIPE BICHO DO MATO		Pág: 059	
	0.71	V 39	02.40.41
		V 36	02.48.42
		V 33	02.58.12
		V 30	03.15.19
		362	T103
	0.76	V 39	02.40.46
		V 36	02.48.47
		V 33	02.58.17
		V 30	03.15.25
		363	T103
	0.84	V 39	02.40.53
		V 36	02.48.55
		V 33	02.58.26
		V 30	03.15.35
		364	T103
	1.04	V 36	02.41.11
		V 33	02.49.15
		V 30	02.58.48
		V 27	03.15.59
		365	T104
☠☠☠☠			
	1.11	V 36	02.41.18
		V 33	02.49.23
		V 30	02.58.56
		V 27	03.16.08
		366	T104
☠☠☠☠			
	1.87	V 21	02.42.34
		V 18	02.50.46
		V 15	03.00.27
		V 12	03.17.50
		367	T105

EQUIPE BICHO DO MATO		Pág: 060	
	2.07	V 39	02.43.09
		V 36	02.51.26
		V 33	03.01.15
		V 30	03.18.50
		368	T106
	2.15	N 1'	02.43.16
		N 1'	02.51.34
		N 1'	03.01.24
		N 1'	03.18.59
		369	T107
	2.15	V 39	02.44.16
		V 36	02.52.34
		V 33	03.02.24
		V 30	03.19.59
		370	T108
	2.37	V 39	02.44.36
		V 36	02.52.56
		V 33	03.02.48
		V 30	03.20.26
		371	T108
	2.48	V 21	02.44.47
		V 18	02.53.07
		V 15	03.03.00
		V 12	03.20.39
		372	T109
ARVORE			
☠			
	2.55	V 21	02.44.59
		V 18	02.53.21
		V 15	03.03.17
		V 12	03.21.00
		373	T109

EQUIPE BICHO DO MATO		Pág: 061	
	2.70	V 27	02.45.24
		V 24	02.53.51
		V 21	03.03.53
		V 18	03.21.45
		374	T110
	2.71	V 27	02.45.26
		V 24	02.53.52
		V 21	03.03.54
		V 18	03.21.47
		375	T110
	2.77	V 27	02.45.34
		V 24	02.54.01
		V 21	03.04.05
		V 18	03.21.59
		376	T110
	2.86	V 27	02.45.46
		V 24	02.54.15
		V 21	03.04.20
		V 18	03.22.17
		377	T110
	2.99	V 27	02.46.03
		V 24	02.54.34
		V 21	03.04.42
		V 18	03.22.43
		378	T110
	3.04	V 33	02.46.10
		V 30	02.54.42
		V 27	03.04.51
		V 24	03.22.53
		379	T111



EQUIPE BICHO DO MATO		Pág: 062	
	3.07	V 33	02.46.13
		V 30	02.54.46
		V 27	03.04.55
		V 24	03.22.57
		380	T111
	3.17	V 33	02.46.24
		V 30	02.54.58
		V 27	03.05.08
		V 24	03.23.12
		381	T111
	3.24	V 33	02.46.31
		V 30	02.55.06
		V 27	03.05.18
		V 24	03.23.23
		382	T111
	3.38	V 33	02.46.47
		V 30	02.55.23
		V 27	03.05.36
		V 24	03.23.44
		383	T111
	3.46	V 33	02.46.55
		V 30	02.55.32
		V 27	03.05.47
		V 24	03.23.56
		384	T111
	3.76	V 33	02.47.28
		V 30	02.56.08
		V 27	03.06.27
		V 24	03.24.41
		385	T111

EQUIPE BICHO DO MATO		Pág: 063	
	3.88	V 33	02.47.41
		V 30	02.56.23
		V 27	03.06.43
		V 24	03.24.59
		386	T111
	3.99	V 33	02.47.53
		V 30	02.56.36
		V 27	03.06.58
		V 24	03.25.15
		387	T111
	4.05	V 33	02.48.00
		V 30	02.56.43
		V 27	03.07.06
		V 24	03.25.24
		388	T111
	4.10	V 33	02.48.05
		V 30	02.56.49
		V 27	03.07.12
		V 24	03.25.32
		389	T111
	4.16	V 21	02.48.12
		V 18	02.56.56
		V 15	03.07.20
		V 12	03.25.41
		390	T112
	4.20	V 21	02.48.19
		V 18	02.57.04
		V 15	03.07.30
		V 12	03.25.53
		391	T112

EQUIPE BICHO DO MATO Pág: 064	
	4.23
	V 21 02.48.24
	V 18 02.57.10
	V 15 03.07.37
	V 12 03.26.02
392	T112
PELA ESQUERDA	
ATOLEIRO	
	4.29
	V 21 02.48.34
	V 18 02.57.22
	V 15 03.07.52
	V 12 03.26.20
393	T112
	4.52
	V 33 02.49.13
	V 30 02.58.08
	V 27 03.08.47
	V 24 03.27.29
394	T113
	4.57
	V 33 02.49.19
	V 30 02.58.14
	V 27 03.08.53
	V 24 03.27.36
395	T113
	4.64
	V 33 02.49.27
	V 30 02.58.23
	V 27 03.09.03
	V 24 03.27.47
396	T113
	4.77
	V 33 02.49.41
	V 30 02.58.38
	V 27 03.09.20
	V 24 03.28.06
397	T113

EQUIPE BICHO DO MATO Pág: 065	
	4.84
	V 33 02.49.48
	V 30 02.58.47
	V 27 03.09.29
	V 24 03.28.17
398	T113
	4.98
	V 33 02.50.04
	V 30 02.59.04
	V 27 03.09.48
	V 24 03.28.38
399	T113
	5.22
	V 33 02.50.30
	V 30 02.59.32
	V 27 03.10.20
	V 24 03.29.14
400	T113
	5.31
	V 33 02.50.40
	V 30 02.59.43
	V 27 03.10.32
	V 24 03.29.27
401	T113
	5.40
	V 33 02.50.49
	V 30 02.59.54
	V 27 03.10.44
	V 24 03.29.41
402	T113
	5.95
	V 33 02.51.49
	V 30 03.01.00
	V 27 03.11.57
	V 24 03.31.03
403	T113
	6.21
	V 33 02.52.18
	V 30 03.01.31
	V 27 03.12.32
	V 24 03.31.42
404	T113

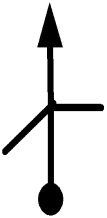
EQUIPE BICHO DO MATO Pág: 066	
	6.23
	V 21 02.52.20
	V 18 03.01.34
	V 15 03.12.35
	V 12 03.31.45
405	T114
	6.41
	V 39 02.52.51
	V 36 03.02.10
	V 33 03.13.18
	V 30 03.32.39
406	T115
	7.03
	N 2' 02.53.48
	N 2' 03.03.12
	N 2' 03.14.26
	N 2' 03.33.54
407	T116
	7.03
	V 15 02.55.48
	V 15 03.05.12
	V 15 03.16.26
	V 12 03.35.54
408	T117
	7.22
	V 30 02.56.34
	V 30 03.05.57
	V 30 03.17.11
	V 27 03.36.51
409	T118
	7.30
	V 30 02.56.43
	V 30 03.06.07
	V 30 03.17.21
	V 27 03.37.01
410	T118
	7.81
	V 30 02.57.44
	V 30 03.07.08
	V 30 03.18.22
	V 27 03.38.09
411	T118

	8.06	
	V 30	02.58.14
	V 30	03.07.38
	V 30	03.18.52
	V 27	03.38.43
412	T118	
	8.14	
	V 30	02.58.24
	V 30	03.07.48
	V 30	03.19.02
	V 27	03.38.53
413	T118	
	8.25	
	V 30	02.58.37
	V 30	03.08.01
	V 30	03.19.15
	V 27	03.39.08
414	T118	

FIM DE PROVA !!www.t15.com.br**Tempo de Prova**

MÉDIA A 02:58:37

MÉDIA B 03:08:01

MÉDIA C 03:19:15

MÉDIA D 03:39:08

FIM