

INICIO

MÉDIA A

MÉDIA B

MÉDIA C

XIII ENDURO DO CARVÃO
04 DE JUNHO DE 2022



IMPORTANTE

CUIDADO

ATENÇÃO

MUITA ATENÇÃO

Tempo de Prova

MÉDIA A 03:02:45

MÉDIA B 03:07:30

MÉDIA C 03:08:24



AFERIÇÃO

ZERAR NA PLACA

0.00

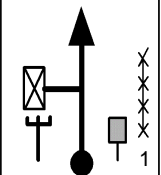

AFER

0.26

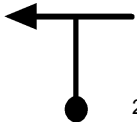

AFER

0.93

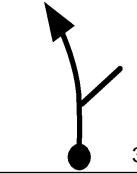

AFER

1.16

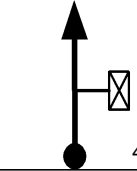

AFER

AFERIR NA PLACA

1.313

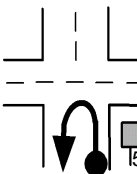

AFER

AFER

RETORNE COM CUIDADO

MOTOS CONTRA

1.50

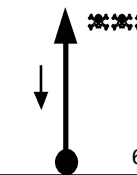

0.00

AFER



INÍCIO DE PROVA

INICIO DE PROVA

BOA SORTE!!

0.00

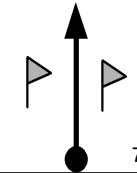

24 00.00.00

24 00.00.00

24 00.00.00

V T1

0.03

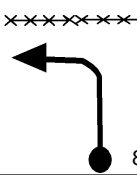

24

24

24 00.00.04

V T1

0.05

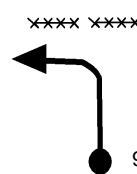

24

24

24 00.00.08

V T1

0.17

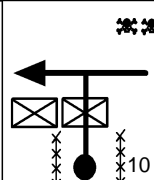

24

24

24 00.00.26

V T1

0.20

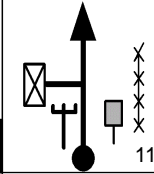

36 00.00.30

33 00.00.30

30 00.00.30

0.00

V T2

0.26

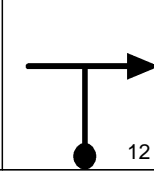

36

33

30 00.01.01

V T2

SUBA

0.31

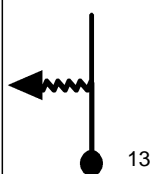

36 00.01.01

30 00.01.04

27 00.01.07

0.31

V T3

COSTEAR TRILHO

0.33

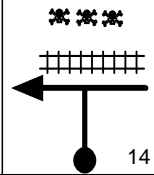

36

30

27 00.01.10

0.33

V T3

ATRAVESSE O TRILHO

DESÇA

0.67

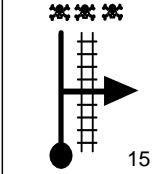

15 00.01.37

12 00.01.47

9 00.01.55

0.67

V T4

0.71

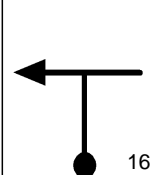

39 00.01.47

33 00.01.59

30 00.02.11

0.71

V T5

CUIDADO - EROSÕES

BUMP

1.06

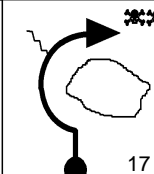

22 00.02.19

19 00.02.37

16 00.02.53

1.06

V T6

1.11

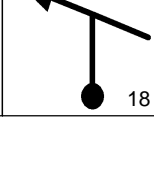

42 00.02.27

36 00.02.47

33 00.03.04

1.11

V T7

04 DE JUNHO DE 2022		Pág: 004	
1.17		42	
		36	
		33	00.03.11
		V	T7
1.29		42	
		36	
		33	00.03.24
		V	T7
NO MATO			
1.48		42	
		36	
		33	00.03.45
		V	T7
1.68		39	00.03.16
		33	00.03.44
		30	00.04.07
		V	T8
BUMP			
1.92		39	
		33	
		30	00.04.35
		V	T8
2.04		39	
		33	
		30	00.04.50
		V	T8
NO MATO			
2.09		36	00.03.54
		30	00.04.28
		27	00.04.56
		V	T9
2.23		36	
		30	
		27	00.05.14
		V	T9
SUBA			
2.51		39	00.04.36
		36	00.05.19
		33	00.05.52
		V	T10
2.56		39	
		36	
		33	00.05.57
		V	T10

04 DE JUNHO DE 2022		Pág: 005	
2.63		33	00.04.47
		30	00.05.31
		27	00.06.05
		V	T11
2.68		33	
		30	
		27	00.06.12
		V	T11
2.77		33	
		30	
		27	00.06.24
		V	T11
2.89		33	
		30	
		27	00.06.40
		V	T11
DESCE			
3.04		21	00.05.32
		18	00.06.20
		15	00.07.00
		V	T12
3.16		30	00.05.52
		27	00.06.44
		24	00.07.28
		V	T13
3.30		24	00.06.09
		21	00.07.03
		18	00.07.49
		V	T14
BUMP			
3.32		24	
		21	
		18	00.07.53
		V	T14
DESCE			
3.42		21	00.06.27
		18	00.07.23
		15	00.08.13
		V	T15
3.54		36	00.06.48
		33	00.07.47
		30	00.08.42
		V	T16

04 DE JUNHO DE 2022		Pág: 006	
3.56		2'	00.06.50
		2'	00.07.49
		2'	00.08.45
		N	T17
CRUZAR TRILHO			
3.56		36	00.08.50
		33	00.09.49
		30	00.10.45
		V	T18
3.60		39	00.08.54
		36	00.09.54
		33	00.10.49
		V	T19
0.00			
0.30		39	
		36	
		33	00.11.22
		V	T19
0.33		39	
		36	
		33	00.11.25
		V	T19
COSTEAR O TRILHO			
0.46		39	
		36	
		33	00.11.40
		V	T19
0.77		42	00.10.05
		39	00.11.11
		36	00.12.13
		V	T20
0.89		42	
		39	
		36	00.12.25
		V	T20
1.00		42	
		39	
		36	00.12.36
		V	T20
1.07		42	
		39	
		36	00.12.43
		V	T20

04 DE JUNHO DE 2022		Pág: 007	
1.39		42	
		39	
		36	00.13.15
		V	T20
1.41		2'	00.10.59
		1'30s	00.12.10
		1'	00.13.17
		N	T21
1.41		39	00.12.59
		36	00.13.40
		33	00.14.17
		V	T22
1.75		39	
		36	
		33	00.14.54
		V	T22
2.03		39	
		36	
		33	00.15.25
		V	T22
COSTEAR CERCA			
2.06		30	00.13.59
		27	00.14.45
		24	00.15.28
		V	T23
COSTEAR A CERCA			
2.12		36	00.14.07
		33	00.14.53
		30	00.15.37
		V	T24
2.23		36	
		33	
		30	00.15.50
		V	T24
2.25		36	
		33	
		30	00.15.53
		V	T24
2.30		36	
		33	
		30	00.15.59
		V	T24

04 DE JUNHO DE 2022		Pág: 008	
2.35		30	00.14.30
		27	00.15.18
		24	00.16.05
		V	T25
2.49		30	
		27	
		24	00.16.26
		V	T25
2.58		42	00.14.57
		39	00.15.49
		36	00.16.39
		V	T26
2.69		42	
		39	
		36	00.16.50
		V	T26
2.76		42	
		39	
		36	00.16.57
		V	T26
3.07		42	
		39	
		36	00.17.28
		V	T26
3.09		1'30s	00.15.41
		1'	00.16.36
		1'	00.17.30
		N	T27
3.09		39	00.17.11
		36	00.17.36
		33	00.18.30
		V	T28
SUBA			
3.32		24	00.17.32
		21	00.17.59
		18	00.18.55
		V	T29

04 DE JUNHO DE 2022		Pág: 009	
3.36		24	
		21	
		18	00.19.03
		V	T29
DESCÇA			
3.41		24	
		21	
		18	00.19.13
		V	T29
3.43		30s	00.17.49
		30s	00.18.17
		30s	00.19.17
		N	T30
NA GERAL			
BUMP			
3.43		24	00.18.19
		21	00.18.47
		18	00.19.47
		V	T31
DESCÇA E			
CRUZE O TRILHO			
3.46		24	
		21	
		18	00.19.53
		V	T31
4.60		36	00.21.14
		33	00.22.08
		30	00.23.41
		V	T32
4.74		39	00.21.28
		36	00.22.23
		33	00.23.58
		V	T33
4.86		39	
		36	
		33	00.24.11
		V	T33
5.15		39	
		36	
		33	00.24.43
		V	T33

04 DE JUNHO DE 2022		Pág: 010	
5.29		39 36 33 00.24.58	V T33
5.48		39 36 33 00.25.19	V T33
5.53		39 36 33 00.25.24	V T33
5.63		39 36 33 00.25.35	V T33
PRESTE ATENÇÃO			
TRILHA ESCONDIDA			
5.72		27 00.22.59 24 00.24.01 21 00.25.45	V T34
5.74		27 24 21 00.25.49	V T34
5.83		27 24 21 00.26.04	V T34
5.85		27 24 21 00.26.07	V T34
5.91		30 00.23.24 27 00.24.30 24 00.26.18	V T35
BUMP			
6.01		30 27 24 00.26.33	V T35



04 DE JUNHO DE 2022		Pág: 011	
6.07		30 27 24 00.26.42	V T35
6.09		30 27 24 00.26.45	V T35
6.15		21 00.23.53 18 00.25.02 15 00.26.54	V T36
6.20		21 18 15 00.27.06	V T36
6.24		21 18 15 00.27.15	V T36
6.28		30 00.24.15 27 00.25.28 24 00.27.25	V T37
6.33		30 27 24 00.27.32	V T37
6.37		30 27 24 00.27.38	V T37
6.51		39 00.24.43 36 00.25.58 33 00.27.59	V T38
6.68		39 36 33 00.28.18	V T38
SUBA			

04 DE JUNHO DE 2022		Pág: 012	
6.94		39 36 33 00.28.46	V T38
NO MATO			
BUMP			
6.97		39 36 33 00.28.50	V T38
7.11		30 00.25.38 27 00.26.58 24 00.29.05	V T39
7.13		30 27 24 00.29.08	V T39
7.18		30 27 24 00.29.15	V T39
7.21		30 27 24 00.29.20	V T39
7.36		39 00.26.08 36 00.27.32 33 00.29.42	V T40
7.39		3'30s 00.26.11 3' 00.27.35 2'30s 00.29.46	N T41
7.39		39 00.29.41 36 00.30.35 33 00.32.16	V T42
PELO ACOSTAMENTO			
7.53		39 00.29.54 36 00.30.49 33 00.32.31	V T43
0.00			V T43

04 DE JUNHO DE 2022		Pág: 013	
0.15		39	
		36	
		33	00.32.47
		V	T43
0.26		39	
		36	
		33	00.32.59
		V	T43
CUIDADO AO CRUZAR			
O ASFALTO			
0.41		21	00.30.32
		18	00.31.30
		15	00.33.16
		V	T44
0.48		21	
		18	
		15	00.33.32
		V	T44
0.59		21	
		18	
		15	00.33.59
		V	T44
0.70		39	00.31.21
		36	00.32.28
		33	00.34.25
		V	T45
0.74		39	
		36	
		33	00.34.30
		V	T45
CUIDADO - ROÇA			
1.05		39	
		36	
		33	00.35.03
		V	T45
NO MATO			
1.30		36	00.32.17
		33	00.33.28
		30	00.35.31
		V	T46
COSTEAR ROÇA			

04 DE JUNHO DE 2022		Pág: 014	
1.37		39	00.32.24
		36	00.33.35
		33	00.35.39
		V	T47
1.56		39	
		36	
		33	00.36.00
		V	T47
1.58		42	00.32.43
		36	00.33.56
		33	00.36.02
		V	T48
1.80		42	
		36	
		33	00.36.26
		V	T48
1.93		42	
		36	
		33	00.36.40
		V	T48
2.30		42	
		36	
		33	00.37.21
		V	T48
2.33		42	
		36	
		33	00.37.24
		V	T48
2.55		27	00.34.06
		21	00.35.33
		18	00.37.48
		V	T49
2.65		27	
		21	
		18	00.38.08
		V	T49

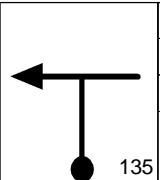
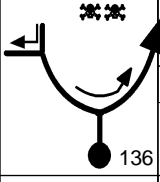
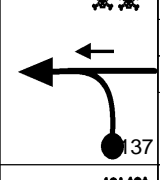
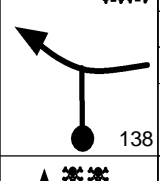
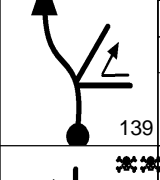
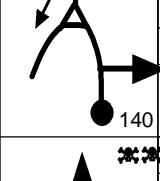
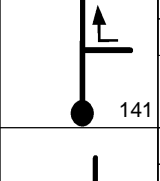
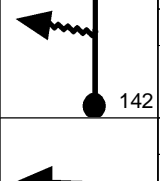
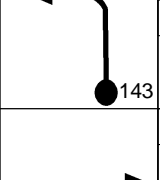
04 DE JUNHO DE 2022		Pág: 015	
2.69		42	00.34.25
		36	00.35.57
		33	00.38.16
		V	T50
2.72		42	
		36	
		33	00.38.19
		V	T50
2.74		42	
		36	
		33	00.38.21
		V	T50
COSTEAR OS EUCALIPTOS			
2.85		42	
		36	
		33	00.38.33
		V	T50
3.13		27	00.35.03
		24	00.36.41
		21	00.39.04
		V	T51
3.20		27	00.35.12
		21	00.36.52
		18	00.39.16
		V	T52
3.31		27	
		21	
		18	00.39.38
		V	T52
3.35		42	00.35.32
		36	00.37.18
		33	00.39.46
		V	T53
3.37		33	00.35.34
		27	00.37.20
		24	00.39.48
		V	T54
3.61		39	00.36.00
		33	00.37.52
		30	00.40.24
		V	T55

04 DE JUNHO DE 2022		Pág: 016	
3.63		39 33 30 00.40.26	V T55
3.86		42 00.36.23 36 00.38.19 33 00.40.54	V T56
4.22		42 36 33 00.41.33	V T56
4.26		42 36 33 00.41.38	V T56
4.48		42 36 33 00.42.02	V T56
4.60		42 36 33 00.42.15	V T56
4.65		42 36 33 00.42.20	V T56
4.67		33 00.37.32 27 00.39.40 24 00.42.22	V T57
4.91		33 27 24 00.42.58	V T57
4.93		39 00.38.01 33 00.40.15 30 00.43.01	V T58
NÃO ERRE!!			

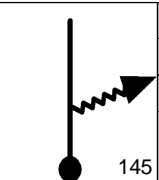
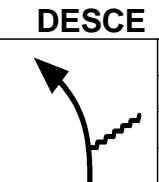
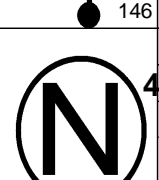
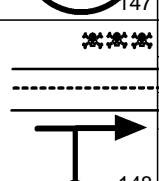
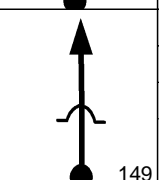
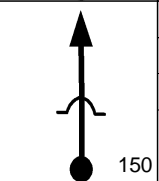
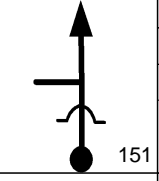
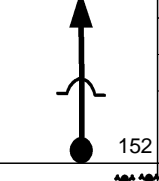
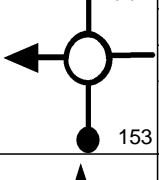
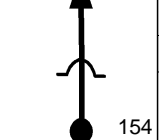
04 DE JUNHO DE 2022		Pág: 017	
5.25		33 00.38.30 27 00.40.49 24 00.43.40	V T59
DESCE			
5.30		33 27 24 00.43.47	V T59
5.49		5' 00.38.56 4'30s 00.41.21 4' 00.44.16	N T60
5.49		45 00.43.56 45 00.45.51 45 00.48.16	V T61
5.93		45 45 45 00.48.51	V T61
6.82		45 45 45 00.50.02	V T61
7.72		45 45 45 00.51.14	V T61
7.88		45 45 45 00.51.27	V T61
8.00		45 45 45 00.51.37	V T61
8.22		45 45 45 00.51.54	V T61

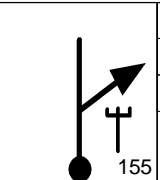
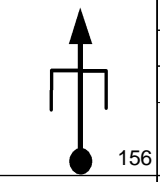
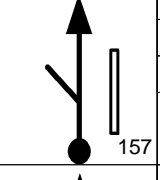
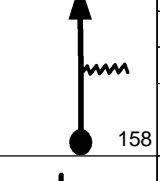
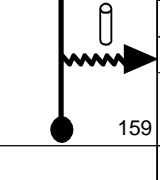
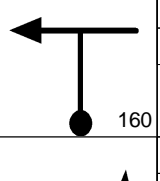
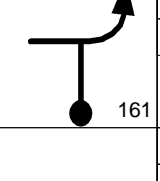
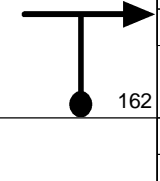
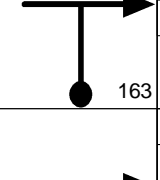
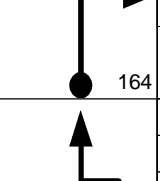
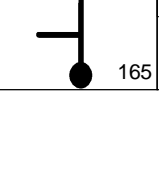
04 DE JUNHO DE 2022		Pág: 018	
9.58		45 45 45 00.53.43	V T61
9.69		42 00.49.32 42 00.51.27 42 00.53.52	V T62
10.00		42 00.49.59 42 00.51.54 42 00.54.18	V T63
0.03		42 42 42 00.54.21	V T63
0.07		24 00.50.05 21 00.52.00 18 00.54.24	V T64
0.08		24 21 18 00.54.26	V T64
0.19		30 00.50.23 27 00.52.21 24 00.54.48	V T65
0.30		30 27 24 00.55.05	V T65
0.40		33 00.50.48 30 00.52.49 27 00.55.20	V T66
0.59		33 30 27 00.55.45	V T66
0.62		33 30 27 00.55.49	V T66

04 DE JUNHO DE 2022		Pág: 019	
0.72		27	00.51.23
		24	00.53.27
		21	00.56.02
		V	T67
0.85		27	
		24	
		21	00.56.25
		V	T67
0.95		30	00.51.54
		27	00.54.02
		24	00.56.42
		V	T68
0.96		30	
		27	
		24	00.56.43
		V	T68
1.08		18	00.52.09
		15	00.54.19
		12	00.57.01
		V	T69
DEGRAU			
1.21		18	
		15	
		12	00.57.40
		V	T69
1.26		18	
		15	
		12	00.57.55
		V	T69
1.29		18	
		15	
		12	00.58.04
		V	T69
1.32		2'	00.52.57
		1'30s	00.55.16
		1'	00.58.13
		N	T70
1.32		42	00.54.57
		36	00.56.46
		33	00.59.13
		V	T71

04 DE JUNHO DE 2022		Pág: 020	
1.60		42	
		36	
		33	00.59.44
		V	T71
2.02		42	
		36	
		33	01.00.30
		V	T71
2.45		30	00.56.34
		27	00.58.39
		24	01.01.17
		V	T72
2.46		30	
		27	
		24	01.01.18
		V	T72
2.58		30	
		27	
		24	01.01.36
		V	T72
2.61		36	00.56.53
		33	00.59.01
		30	01.01.41
		V	T73
2.78		36	
		33	
		30	01.02.01
		V	T73
2.81		36	
		33	
		30	01.02.05
		V	T73
2.84		39	00.57.16
		36	00.59.26
		33	01.02.08
		V	T74

04 DE JUNHO DE 2022		Pág: 021	
2.93		36	00.57.25
		33	00.59.35
		30	01.02.18
		V	T75
3.03		36	
		33	
		30	01.02.30
		V	T75
3.07		36	
		33	
		30	01.02.35
		V	T75
3.09		36	
		33	
		30	01.02.37
		V	T75
3.18		36	
		33	
		30	01.02.48
		V	T75
3.28		36	
		33	
		30	01.03.00
		V	T75
3.51		36	
		33	
		30	01.03.28
		V	T75
3.64		3'	00.58.36
		2'30s	01.00.52
		2'30s	01.03.43
		N	T76
3.64		39	01.01.36
		39	01.03.22
		39	01.06.13
		V	T77
3.93		39	
		39	
		39	01.06.40
		V	T77
4.08		30	01.02.16
		27	01.04.03
		24	01.06.54
		V	T78

04 DE JUNHO DE 2022		Pág: 022	
4.32		30	
		27	
		24	01.07.30
		V	T78
4.36		30	
		27	
		24	01.07.36
		V	T78
ATENÇÃO			
4.45		30	
		27	
		24	01.07.49
		V	T78
4.57		30	
		27	
		24	01.08.07
		V	T78
4.61		36	01.03.20
		33	01.05.14
		30	01.08.13
		V	T79
4.76		36	
		33	
		30	01.08.31
		V	T79
4.88		39	01.03.47
		36	01.05.43
		33	01.08.46
		V	T80
5.17		39	
		36	
		33	01.09.17
		V	T80
ATENÇÃO			
5.30		33	01.04.26
		30	01.06.25
		27	01.09.32
		V	T81
5.33		33	
		30	
		27	01.09.36
		V	T81





04 DE JUNHO DE 2022		Pág: 023	
5.37		33	
		30	
		27	01.09.41
		V	T81
5.46		33	
		30	
		27	01.09.53
		V	T81
SUBA			
5.61		39	01.04.59
		36	01.07.02
		33	01.10.13
		V	T82
5.69		39	
		36	
		33	01.10.22
		V	T82
5.76		39	
		36	
		33	01.10.29
		V	T82
5.79		39	
		36	
		33	01.10.33
		V	T82
5.90		39	
		36	
		33	01.10.45
		V	T82
6.08		30	01.05.43
		27	01.07.49
		24	01.11.04
		V	T83
6.16		30	
		27	
		24	01.11.16
		V	T83
6.19		30	
		27	
		24	01.11.21
		V	T83





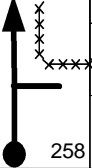

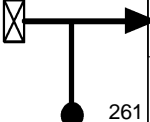
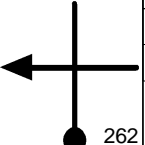
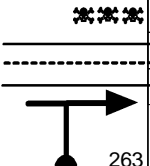

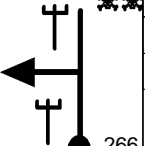
04 DE JUNHO DE 2022		Pág: 024	
6.28		27	01.06.07
		24	01.08.16
		21	01.11.34
		V	T84
6.30		27	
		24	
		21	01.11.38
		V	T84
6.41		36	01.06.24
		33	01.08.35
		30	01.11.56
		V	T85
6.65		2'30s	01.06.48
		2'	01.09.02
		2'	01.12.25
		N	T86
6.65		36	01.09.18
		33	01.11.02
		30	01.14.25
		V	T87
6.70		36	
		33	
		30	01.14.31
		V	T87
6.92		33	01.09.45
		30	01.11.31
		27	01.14.58
		V	T88
7.28		33	
		30	
		27	01.15.46
		V	T88
7.52		33	
		30	
		27	01.16.18
		V	T88
7.60		33	
		30	
		27	01.16.28
		V	T88
7.78		33	
		30	
		27	01.16.52
		V	T88



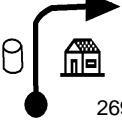

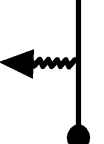

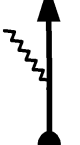
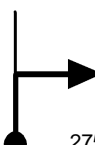
04 DE JUNHO DE 2022		Pág: 025	
7.81		30 01.11.22 27 01.13.18 24 01.16.56	V T89
7.87		30 27 24 01.17.05	V T89
7.89		30 27 24 01.17.08	V T89
7.93		30 27 24 01.17.14	V T89
7.95		36 01.11.39 33 01.13.36 30 01.17.17	V T90
8.14		36 33 30 01.17.40	V T90
8.21		36 33 30 01.17.49	V T90
8.43		36 33 30 01.18.15	V T90
8.56		36 33 30 01.18.31	V T90
8.65		36 33 30 01.18.41	V T90
8.71		30 01.12.55 27 01.14.59 24 01.18.49	V T91



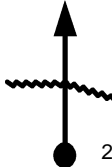

04 DE JUNHO DE 2022		Pág: 026	
8.80		30 27 24 01.19.02	V T91
8.84		30 27 24 01.19.08	V T91
8.90		30 27 24 01.19.17	V T91
8.94		30 27 24 01.19.23	V T91
9.12		39 01.13.44 33 01.15.54 30 01.19.50	V T92
9.13		39 33 30 01.19.51	V T92
9.24		39 33 30 01.20.04	V T92
9.42		39 33 30 01.20.26	V T92
9.61		30 01.14.29 27 01.16.48 24 01.20.49	V T93

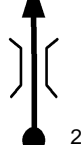
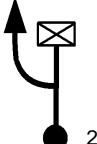

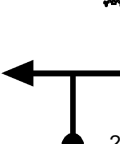
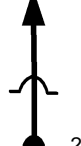
04 DE JUNHO DE 2022		Pág: 027	
9.64		39 01.14.33 33 01.16.52 30 01.20.53	V T94
9.84		39 33 30 01.21.17	V T94
9.86		39 33 30 01.21.20	V T94
10.05		39 01.15.11 33 01.17.36 30 01.21.43	V T95
0.00			V T95
0.16		39 33 30 01.22.02	V T95
0.19		3' 01.15.28 2' 01.17.57 1' 01.22.05	N T96
NA GERAL			
0.19		36 01.18.28 33 01.19.57 30 01.23.05	V T97
0.25		36 33 30 01.23.13	V T97
0.28		36 33 30 01.23.16	V T97
0.55		36 33 30 01.23.49	V T97

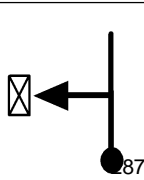

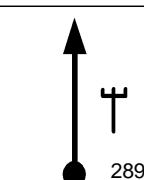
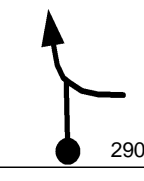
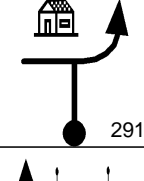
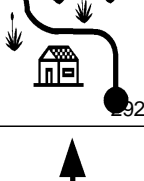
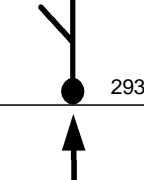
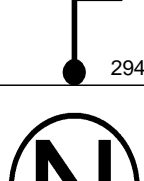
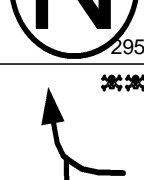
04 DE JUNHO DE 2022		Pág: 028	
0.70		36	
		33	
		30	01.24.07
	257	V	T97
0.77		30	01.19.26
		27	01.21.00
		24	01.24.15
		258	V
0.93		30s	01.19.46
		30s	01.21.22
		30s	01.24.39
		259	N
RESPEITE OS MORADORES			
0.93		36	01.20.16
		36	01.21.52
		36	01.25.09
		260	V
1.30		36	
		36	
		36	01.25.46
		261	V
1.48		36	
		36	
		36	01.26.04
		262	V
SIGA PELO ACOSTAMENTO			
2.51		39	01.22.54
		39	01.24.30
		39	01.27.47
		263	V
2.86		39	
		39	
		39	01.28.19
		264	V
3.26		39	
		39	
		39	01.28.56
		265	V
CUIDADO AO CRUZAR			
3.35		39	
		39	
		39	01.29.04
		266	V

04 DE JUNHO DE 2022		Pág: 029	
3.75		39	
		39	
		39	01.29.41
		267	V
3.94		39	
		39	
		39	01.29.59
		268	V
CUIDADO - BUEIRO			
4.05		45	01.25.16
		42	01.26.52
		39	01.30.09
		269	V
NO MATO			
4.63		24	01.26.02
		21	01.27.41
		18	01.31.03
		270	V
4.80		24	
		21	
		18	01.31.37
		271	V
4.83		24	
		21	
		18	01.31.43
		272	V
COSTEAR ROÇA			
4.88		42	01.26.40
		36	01.28.24
		33	01.31.53
		273	V
5.14		42	
		36	
		33	01.32.21
		274	V
5.19		30	01.27.06
		27	01.28.55
		24	01.32.26
		275	V
BUMP			
0.02		30	
		27	
		24	01.32.29
		276	V

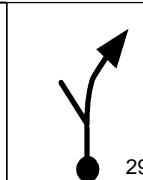
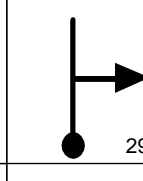
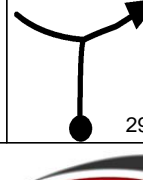
04 DE JUNHO DE 2022		Pág: 030	
NO MATO - BUMP			
TOCO DE ÁRVORE			
0.14		24	01.27.23
		18	01.29.14
		15	01.32.47
		277	V
DESÇA			
0.45		24	
		18	
		15	01.34.02
		278	V
0.57		27	01.28.27
		24	01.30.40
		21	01.34.31
		279	V
0.79		27	
		24	
		21	01.35.08
		280	V
0.84		27	
		24	
		21	01.35.17
		281	V
0.88		39	01.29.09
		36	01.31.26
		33	01.35.24
		282	V
1.84		39	
		36	
		33	01.37.08
		283	V
1.86		3'	01.30.39
		3'	01.33.04
		2'	01.37.11
		284	N
NA GERAL			
1.86		42	01.33.39
		42	01.36.04
		42	01.39.11
		285	V
2.39		42	
		42	
		42	01.39.56
		286	V

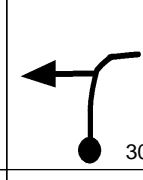
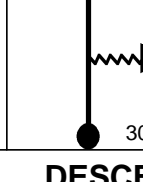
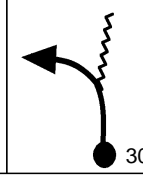
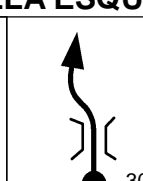
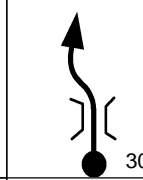
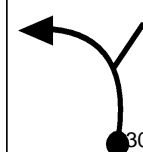
04 DE JUNHO DE 2022		Pág: 031	
2.62		42 42 42	01.40.16
		V	T110
2.67		11' 10' 10'	01.34.49 01.37.14 01.40.20
		N	T111
APOIO			
2.67		27 24 21	01.45.49 01.47.14 01.50.20
0.00		V	T112
0.04		27 24 21	01.50.27
		V	T112
0.09		27 24 21	01.50.36
		V	T112
0.12		27 24 21	01.50.41
		V	T112
0.20		39 36 33	01.46.15 01.47.44 01.50.54
		V	T113
0.95		39 36 33	01.52.16
		V	T113
1.19		1' 1' 1'	01.47.47 01.49.23 01.52.42
		N	T114
1.19		** 39 39 39	01.48.47 01.50.23 01.53.42
		V	T115

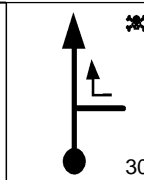
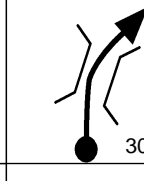
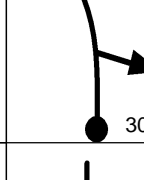
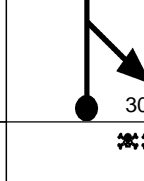
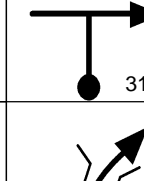
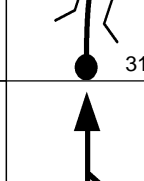
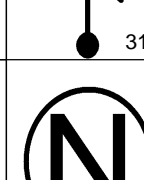
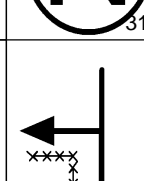
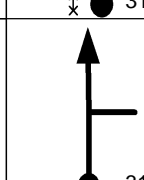
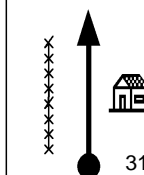
04 DE JUNHO DE 2022		Pág: 032	
1.75		39 39 39	01.54.34
		V	T115
1.77		36 36 36	01.49.40 01.51.16 01.54.36
		V	T116
2.15		39 39 39	01.50.18 01.51.54 01.55.14
		V	T117
			
2.49		39 39 39	01.55.45
		V	T117
2.53		21 18 15	01.50.53 01.52.29 01.55.49
		V	T118
DESCE			
2.54		21 18 15	01.55.51
		V	T118
PELA ESQUERDA			
2.62		30 24 21	01.51.09 01.52.47 01.56.11
		V	T119
2.82		30 24 21	01.56.45
		V	T119
2.93		30 24 21	01.57.04
		V	T119

04 DE JUNHO DE 2022		Pág: 033	
2.94		** 30 24 21	01.57.05
		V	T119
3.01		30 24 21	01.57.17
		V	T119
3.07		27 24 21	01.52.03 01.53.55 01.57.28
		V	T120
3.11		27 24 21	01.57.35
		V	T120
3.20		** 30 24 21	01.52.20 01.54.14 01.57.50
		V	T121
3.26		30 24 21	01.58.00
		V	T121
3.31		39 36 33	01.52.33 01.54.31 01.58.09
		V	T122
3.68		3' 2' 2'	01.53.07 01.55.08 01.58.49
		N	T123
3.68		21 21 21	01.56.07 01.57.08 02.00.49
		V	T124
3.69		21 21 21	02.00.51
		V	T124
3.80		21 21 21	02.01.10
		V	T124

04 DE JUNHO DE 2022		Pág: 034	
3.87		21	
		21	
		21	02.01.22
		V	T124
CUIDADO - EST GERAL			
4.03		39	01.57.07
		36	01.58.08
		33	02.01.49
		V	T125
4.34		42	01.57.36
		36	01.58.39
		33	02.02.23
		V	T126
4.70		42	
		36	
		33	02.03.02
		V	T126
4.80		24	01.58.15
		21	01.59.25
		18	02.03.13
		V	T127
4.86		24	
		21	
		18	02.03.25
		V	T127
4.98		24	
		21	
		18	02.03.49
		V	T127
5.03		24	
		21	
		18	02.03.59
		V	T127
5.12		24	
		21	
		18	02.04.17
		V	T127
5.18		36	01.59.12
		30	02.00.30
		27	02.04.29
		V	T128

04 DE JUNHO DE 2022		Pág: 035	
5.43		36	
		30	
		27	02.05.03
		V	T128
5.49		36	
		30	
		27	02.05.11
		V	T128
5.51		39	01.59.45
		36	02.01.10
		33	02.05.13
		V	T129
5.55		39	
		36	
		33	02.05.18
		V	T129
5.62		39	
		36	
		33	02.05.25
		V	T129
5.65		39	
		36	
		33	02.05.28
		V	T129
5.68		39	
		36	
		33	02.05.32
		V	T129
6.00		39	
		36	
		33	02.06.07
		V	T129
6.04		39	
		36	
		33	02.06.11
		V	T129
6.47		39	
		36	
		33	02.06.58
		V	T129
6.49		36	02.01.16
		33	02.02.48
		30	02.07.00
		V	T130

04 DE JUNHO DE 2022		Pág: 036	
6.64		36	
		33	
		30	02.07.18
		V	T130
6.77		39	02.01.44
		33	02.03.18
		30	02.07.34
		V	T131
6.88		39	
		33	
		30	02.07.47
		V	T131
7.19		39	02.02.23
		36	02.04.04
		33	02.08.24
		V	T132
7.42		3'	02.02.44
		2'	02.04.27
		1'	02.08.49
		N	T133
7.42		39	02.05.44
		33	02.06.27
		30	02.09.49
		V	T134
7.52		39	
		33	
		30	02.10.01
		V	T134
7.66		39	
		33	
		30	02.10.18
		V	T134
7.68		39	
		33	
		30	02.10.20
		V	T134
7.71		39	
		33	
		30	02.10.24
		V	T134
BUMP			

04 DE JUNHO DE 2022		Pág: 037	
7.76		39 33 30 02.10.30	V T134
7.83		39 33 30 02.10.38	V T134
7.94		39 33 30 02.10.52	V T134
7.96		39 33 30 02.10.54	V T134
8.00		39 33 30 02.10.59	V T134
8.26		27 02.07.01 24 02.07.59 21 02.11.30	V T135
8.46		36 02.07.28 33 02.08.29 30 02.12.04	V T136
8.52		36 33 30 02.12.11	V T136
8.61		36 33 30 02.12.22	V T136
8.65		2' 02.07.47 2' 02.08.49 30 02.12.27	N T137
8.65		39 02.09.47 36 02.10.49 33 02.13.57	V T138

04 DE JUNHO DE 2022		Pág: 038	
8.72		27 02.09.54 24 02.10.56 21 02.14.05	V T139
NO MATO			
8.77		27 24 21 02.14.13	V T139
8.94		36 02.10.23 30 02.11.29 27 02.14.42	V T140
8.99		36 30 27 02.14.49	V T140
9.04		33 02.10.33 30 02.11.41 27 02.14.56	V T141
9.22		33 30 27 02.15.20	V T141
9.29		33 30 27 02.15.29	V T141
9.65		39 02.11.39 36 02.12.55 33 02.16.17	V T142
9.67		39 36 33 02.16.19	V T142

04 DE JUNHO DE 2022		Pág: 039	
9.70		39 36 33 02.16.23	V T142
9.78		39 36 33 02.16.31	V T142
9.81		39 36 33 02.16.35	V T142
9.87		39 36 33 02.16.41	V T142
9.95		39 36 33 02.16.50	V T142
10.10		39 02.12.21 36 02.13.40 33 02.17.06	V T143
0.00		V T143	
0.15		39 36 33 02.17.23	V T143
0.19		39 36 33 02.17.27	V T143
0.26		39 36 33 02.17.35	V T143
0.28		39 36 33 02.17.37	V T143
0.31		39 36 33 02.17.40	V T143

04 DE JUNHO DE 2022		Pág: 040	
0.62		39 36 33 02.18.14	V T143
0.68		39 36 33 02.18.20	V T143
1.11		39 36 33 02.19.07	V T143
1.12		39 36 33 02.19.08	V T143
1.19		39 36 33 02.19.16	V T143
1.30		2' 02.14.21 2' 02.15.50 1' 02.19.28	N T144
1.30		39 02.16.21 36 02.17.50 33 02.20.28	V T145
1.46		36 02.16.36 30 02.18.06 27 02.20.45	V T146
1.65		36 30 27 02.21.11	V T146
1.71		39 02.17.01 33 02.18.36 30 02.21.19	V T147
1.89		39 33 30 02.21.40	V T147

04 DE JUNHO DE 2022		Pág: 041	
1.96		39 33 30 02.21.49	V T147
2.08		36 02.17.35 33 02.19.16 30 02.22.03	V T148
2.27		36 33 30 02.22.26	V T148
2.33		21 02.18.00 18 02.19.43 15 02.22.33	V T149
2.36		33 02.18.05 30 02.19.49 27 02.22.40	V T150
2.44		33 30 27 02.22.51	V T150
EROSÕES			
2.64		21 02.18.36 18 02.20.23 15 02.23.18	V T151
CUIDADO - CERCA			
2.68		21 18 15 02.23.27	V T151
NÃO ERRE			
2.74		39 02.18.53 33 02.20.43 30 02.23.42	V T152
2.93		33 02.19.10 30 02.21.04 27 02.24.04	V T153





04 DE JUNHO DE 2022		Pág: 042	
3.14		21 02.19.33 18 02.21.29 15 02.24.32	V T154
CUIDADO - CERCA			
3.18		21 18 15 02.24.42	V T154
3.23		39 02.19.49 33 02.21.47 30 02.24.54	V T155
3.28		39 33 30 02.25.00	V T155
3.67		3' 02.20.29 2' 02.22.35 2' 02.25.47	N T156
DESÇA - BUMP			
3.67		21 02.23.29 18 02.24.35 15 02.27.47	V T157
3.71		36 02.23.36 33 02.24.43 30 02.27.56	V T158
4.02		36 33 30 02.28.34	V T158
4.18		36 33 30 02.28.53	V T158
4.25		36 33 30 02.29.01	V T158





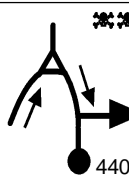
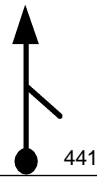
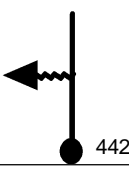
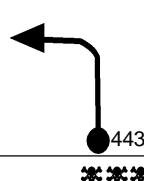
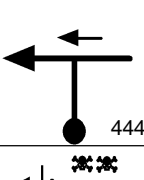

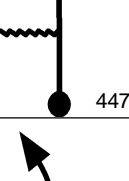
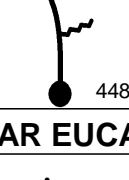
04 DE JUNHO DE 2022		Pág: 043	
4.57		36	
		33	
		30	02.29.40
		V	T158
4.61		39	02.25.06
		33	02.26.21
		30	02.29.44
		V	T159
4.87		39	
		33	
		30	02.30.16
		V	T159
4.93		39	
		33	
		30	02.30.23
		V	T159
5.07		33	02.25.48
		30	02.27.11
		27	02.30.40
		V	T160
5.18		36	02.26.00
		33	02.27.24
		30	02.30.54
		V	T161
5.28		39	02.26.10
		36	02.27.35
		33	02.31.06
		V	T162
5.53		39	
		36	
		33	02.31.34
		V	T162
5.74		2'	02.26.53
		3'	02.28.21
		2'	02.31.57
		N	T163
5.74		21	02.28.53
		18	02.31.21
		15	02.33.57
		V	T164



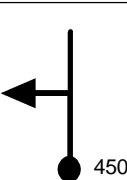
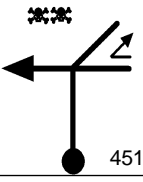

04 DE JUNHO DE 2022		Pág: 044	
5.94		42	02.29.27
		42	02.32.01
		42	02.34.45
		V	T165
6.53		42	
		42	
		42	02.35.35
		V	T165
6.81		42	
		42	
		42	02.35.59
		V	T165
7.24		42	
		42	
		42	02.36.36
		V	T165
CUIDADO AO CRUZAR			
7.35		39	02.31.28
		33	02.34.02
		30	02.36.45
		V	T166
7.49		39	
		33	
		30	02.37.02
		V	T166
7.81		39	
		33	
		30	02.37.41
		V	T166
8.05		39	
		33	
		30	02.38.09
		V	T166
8.11		39	
		33	
		30	02.38.17
		V	T166
8.13		39	
		33	
		30	02.38.19
		V	T166

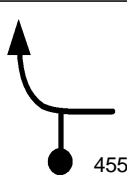
04 DE JUNHO DE 2022		Pág: 045	
8.15		39	
		33	
		30	02.38.21
		V	T166
COSTEAR EUCALIPTOS			
8.26		39	
		33	
		30	02.38.35
		V	T166
8.55		27	02.33.19
		24	02.36.13
		21	02.39.09
		V	T167
8.62		42	02.33.28
		36	02.36.23
		33	02.39.21
		V	T168
8.84		42	
		36	
		33	02.39.45
		V	T168
8.86		42	
		36	
		33	02.39.48
		V	T168
ATENÇÃO			
9.22		42	
		36	
		33	02.40.27
		V	T168
9.28		24	02.34.25
		21	02.37.29
		18	02.40.33
		V	T169
9.32		24	
		21	
		18	02.40.41
		V	T169
9.43		42	02.34.47
		36	02.37.55
		33	02.41.03
		V	T170

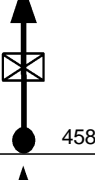
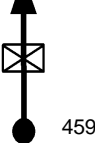
04 DE JUNHO DE 2022		Pág: 046	
9.55		42 36 33 02.41.16	V T170
9.60		42 36 33 02.41.22	V T170
9.63		30 02.35.04 27 02.38.15 24 02.41.25	V T171
9.86		30 27 24 02.42.00	V T171
9.88		39 02.35.34 33 02.38.48 30 02.42.03	V T172
10.12		42 02.35.56 36 02.39.15 33 02.42.31	V T173
0.00			
0.06		42 36 33 02.42.38	V T173
0.08		42 36 33 02.42.40	V T173
0.10		42 36 33 02.42.42	V T173
COSTEAR EUCALIPTOS			
0.20		42 36 33 02.42.53	V T173

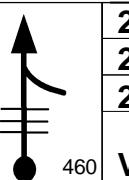
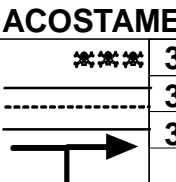

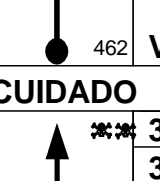
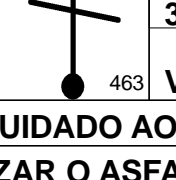
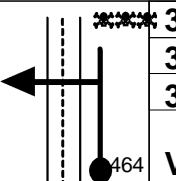
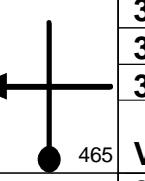
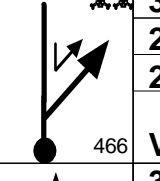
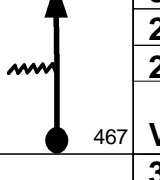



04 DE JUNHO DE 2022		Pág: 047	
0.50		27 02.36.39 24 02.40.05 21 02.43.26	V T174
0.56		42 02.36.47 36 02.40.14 33 02.43.36	V T175
0.78		42 36 33 02.44.00	V T175
COSTEAR ROÇA			
0.80		36 02.37.08 33 02.40.38 30 02.44.02	V T176
0.99		36 33 30 02.44.25	V T176
1.06		39 02.37.34 36 02.41.06 33 02.44.34	V T177
1.32		39 36 33 02.45.02	V T177
1.66		4' 02.38.29 4' 02.42.06 2' 02.45.39	N T178
1.66		21 02.42.29 21 02.46.06 21 02.47.39	V T179
1.78		21 21 21 02.48.00	V T179







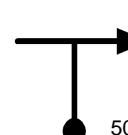
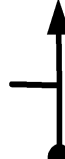

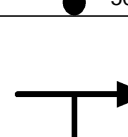
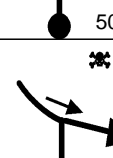
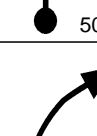
04 DE JUNHO DE 2022		Pág: 048	
1.88		21 21 21 02.48.17	V T179
PELO ACOSTAMENTO			
1.96		39 02.43.21 39 02.46.57 39 02.48.31	V T180
CUIDADO			
2.09		39 39 39 02.48.43	V T180
CUIDADO			
2.19		39 39 39 02.48.52	V T180
CUIDADO AO			
CRUZAR O ASFALTO			
2.37		39 39 39 02.49.08	V T180
2.51		39 39 39 02.49.21	V T180
2.54		30 02.44.14 27 02.47.51 24 02.49.24	V T181
2.69		30 27 24 02.49.47	V T181
2.71		30 27 24 02.49.50	V T181



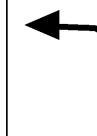

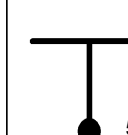
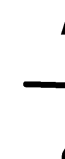

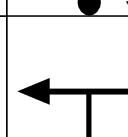
04 DE JUNHO DE 2022		Pág: 049	
2.77		30 27 24 02.49.59	V T181
2.80		30 27 24 02.50.03	V T181
2.84		*** 39 02.44.50 36 02.48.31 33 02.50.09	V T182
2.87		39 36 33 02.50.12	V T182
2.94		39 36 33 02.50.20	V T182
DESCE			
3.00		39 36 33 02.50.27	V T182
3.03		39 36 33 02.50.30	V T182
3.29		39 36 33 02.50.58	V T182
3.32		39 36 33 02.51.01	V T182
3.47		*** 33 02.45.48 30 02.49.34 27 02.51.18	V T183

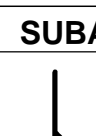

04 DE JUNHO DE 2022		Pág: 050	
3.62		33 30 27 02.51.38	V T183
3.64		33 30 27 02.51.40	V T183
3.70		*** 33 30 27 02.51.48	V T183
3.72		33 30 27 02.51.51	V T183
3.78		30 02.46.22 27 02.50.11 24 02.51.59	V T184
3.84		30 27 24 02.52.08	V T184
3.88		30 27 24 02.52.14	V T184
SALTE!!			
3.95		30 27 24 02.52.25	V T184
3.96		2' 02.46.44 2' 02.50.35 1' 02.52.26	N T185

04 DE JUNHO DE 2022		Pág: 051	
3.96		30 02.48.44 27 02.52.35 24 02.53.26	V T186
4.09		27 02.48.59 24 02.52.52 21 02.53.46	V T187
4.11		27 24 21 02.53.49	V T187
SIGA BUMP			
4.13		27 24 21 02.53.52	V T187
SUBA			
4.23		*** 27 24 21 02.54.10	V T187
4.49		33 02.49.53 30 02.53.52 27 02.54.54	V T188
0.00			V T188
0.12		33 30 27 02.55.10	V T188
0.25		33 30 27 02.55.28	V T188
0.32		*** 33 30 27 02.55.37	V T188
0.38		33 02.50.34 27 02.54.38 24 02.55.45	V T189

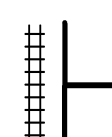
04 DE JUNHO DE 2022		Pág: 052	
0.57		36	02.50.55
		33	02.55.03
		30	02.56.13
		V	T190
0.66		39	02.51.04
		36	02.55.13
		33	02.56.24
		V	T191
0.80		39	
		36	
		33	02.56.39
		V	T191
0.84		39	
		36	
		33	02.56.44
		V	T191
0.97		39	
		36	
		33	02.56.58
		V	T191
1.21		39	
		36	
		33	02.57.24
		V	T191
SUBA			
1.41		39	
		36	
		33	02.57.46
		V	T191
1.59		39	
		36	
		33	02.58.06
		V	T191
1.84		39	
		36	
		33	02.58.33
		V	T191
1.89		30	02.52.57
		27	02.57.16
		24	02.58.38
		V	T192

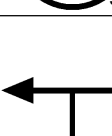
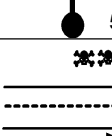
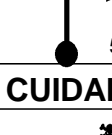
04 DE JUNHO DE 2022		Pág: 053	
2.08		30	
		27	
		24	02.59.07
		V	T192
2.17		39	02.53.31
		36	02.57.54
		33	02.59.20
		V	T193
2.31		39	
		36	
		33	02.59.36
		V	T193
2.36		39	
		36	
		33	02.59.41
		V	T193
2.49		39	
		36	
		33	02.59.55
		V	T193
2.72		39	
		36	
		33	03.00.20
		V	T193
SUBA			
2.92		39	
		36	
		33	03.00.42
		V	T193
3.11		39	
		36	
		33	03.01.03
		V	T193
3.23		2'	02.55.09
		2'	02.59.40
		1'	03.01.16
		N	T194
3.23		39	02.57.09
		36	03.01.40
		33	03.02.16
		V	T195

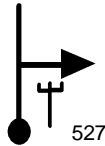
04 DE JUNHO DE 2022		Pág: 054	
3.29		21	02.57.14
		18	03.01.46
		15	03.02.22
		V	T196
EROSÕES			
3.31		39	02.57.18
		36	03.01.50
		33	03.02.27
		V	T197
SUBA			
3.70		18	02.57.54
		15	03.02.29
		13	03.03.10
		V	T198
CRUZE O TRILHO			
3.73		36	02.58.00
		33	03.02.36
		30	03.03.18
		V	T199
DESCE			
4.08		36	
		33	
		30	03.04.00
		V	T199
4.11		1'	02.58.38
		1'	03.03.17
		1'	03.04.04
		N	T200
4.11		39	02.59.38
		36	03.04.17
		33	03.05.04
		V	T201
4.29		39	
		36	
		33	03.05.23
		V	T201
CUIDADO			
4.51		39	
		36	
		33	03.05.47
		V	T201

4.64		30	03.00.27
		27	03.05.10
		24	03.06.02
		V	T202
4.68		2'	03.00.32
		2'	03.05.16
		2'	03.06.08
		N	T203

ENTREGUE O GPS

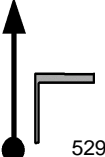
4.68		30	03.02.32
		27	03.07.16
		24	03.08.08
		V	T204

VÁ TRANQUILO...

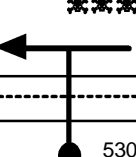
4.70		30	
		27	
		24	03.08.11
		V	T204

QUASE CHEGANDO

4.73		30	
		27	
		24	03.08.15
		V	T204

VOCÊ CHEGOU!!

SINTA-SE À VONTADE

EM NOSSA SEDE!!

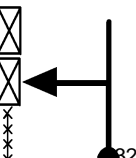
4.79		30	03.02.45
		27	03.07.30
		24	03.08.24
		V	T204

FIM DE PROVA !!



www.t15.com.br

A EQUIPE TRILHEIROS DO CARVÃO
AGRADECE A SUA PRESENÇA NESSE
XIII ENDURO DO CARVÃO.
ESPERAMOS VOCÊ EM 2023

www.trilheirosdocarvao.com.br

Tempo de Prova

MÉDIA A 03:02:45

MÉDIA B 03:07:30

MÉDIA C 03:08:24

FIM