

INICIO

MEDIA A

MEDIA B

MEDIA C

BICHOMATO2022
29 OUTUBRO 2022



IMPORTANTE



Tempo de Prova

MEDIA A 02:34:18

MEDIA B 02:41:25

MEDIA C 02:49:48



AFERIÇÃO

INICIO DE AFERIÇÃO

ZERAR NA PLACA

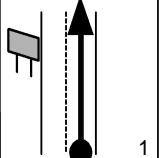
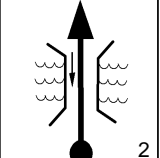
0.00		1	AFER
0.00		2	AFER

0.40



3

AFER

0.44



4

AFER

0.63

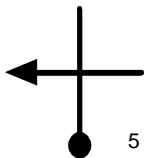

5

AFER

0.70

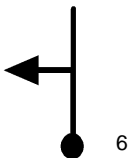

6

AFER

0.89



7

AFER

0.93



8

AFER

1.12

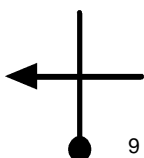

9

AFER

1.19

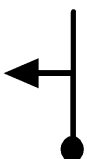

10

AFER

1.38



11

AFER

1.41



12

AFER

FINAL DE AFERIÇÃO

1.80 NA PLACA

1.80
0.00

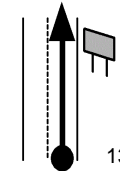

13

AFER



INÍCIO DE PROVA

INICIO DE PROVA

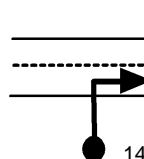
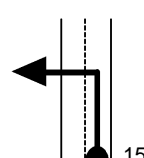
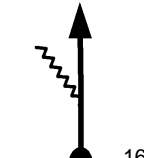
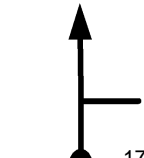
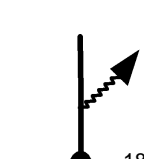
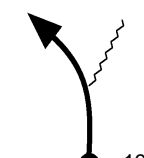
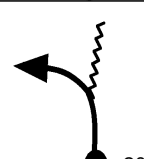
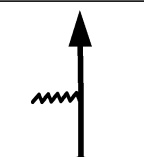
0.00		24	00.00.00
		24	00.00.00
		24	00.00.00
V	T1		
0.33		48	00.00.50
		45	00.00.50
		42	00.00.50
V	T2		
1.42		48	
		45	
		42	00.02.23
V	T2		
1.50		48	
		45	
		42	00.02.30
V	T2		
1.62		48	
		45	
		42	00.02.40
V	T2		
2.03		48	
		45	
		42	00.03.15
V	T2		
2.26		48	
		45	
		42	00.03.35
V	T2		
2.58		48	
		45	
		42	00.04.02
V	T2		

29 OUTUBRO 2022		Pág: 004	
2.65		48	
		45	
		42	00.04.08
V	T2		
2.94		48	
		45	
		42	00.04.33
V	T2		
3.13		48	
		45	
		42	00.04.50
V	T2		
3.15		48	
		45	
		42	00.04.51
V	T2		
3.19		48	00.04.24
		45	00.04.38
		42	00.04.55
V	T3		
0.00			
0.55		48	
		45	
		42	00.05.42
V	T3		
0.74		48	
		45	
		42	00.05.58
V	T3		
1.03		48	
		45	
		42	00.06.23
V	T3		
VALO			
1.06		48	
		45	
		42	00.06.25
V	T3		
1.10		48	
		45	
		42	00.06.29
V	T3		







29 OUTUBRO 2022		Pág: 005	
1.31		27	00.06.02
		30	00.06.23
		30	00.06.47
V	T4		
1.58		27	
		30	
		30	00.07.19
V	T4		
CUIDADO			
1.62		27	
		30	
		30	00.07.24
V	T4		
PLACA			
2.06		36	00.07.42
		33	00.07.53
		30	00.08.17
V	T5		
2.19		36	
		33	
		30	00.08.33
V	T5		
2.34		36	
		33	
		30	00.08.51
V	T5		
2.58		48	00.08.34
		45	00.08.50
		43	00.09.19
V	T6		
2.79		48	
		45	
		43	00.09.37
V	T6		
3.08		48	
		45	
		43	00.10.01
V	T6		
3.47		48	
		45	
		43	00.10.34
V	T6		



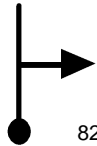
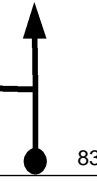
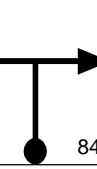

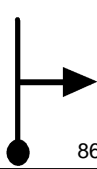
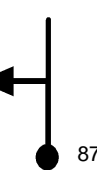
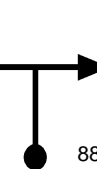

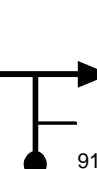
29 OUTUBRO 2022		Pág: 006	
3.50		48	
		45	
		43	00.10.36
V	T6		
4.06		48	
		45	
		43	00.11.23
V	T6		
4.25		48	
		45	
		43	00.11.39
V	T6		
4.54		48	
		45	
		43	00.12.03
V	T6		
4.79		2'	00.11.20
		2'	00.11.47
		2'	00.12.24
N	T7		
4.79		27	00.13.20
		27	00.13.47
		27	00.14.24
V	T8		
5.07		27	
		27	
		27	00.15.02
V	T8		
5.92		27	
		27	
		27	00.16.55
V	T8		
6.00		27	
		27	
		27	00.17.06
V	T8		
INÍCIO DESLOCAMENTO			
6.06		4'	00.16.09
		4'	00.16.36
		4'	00.17.14
D	T9		



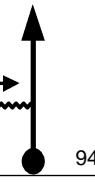
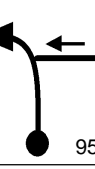
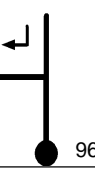



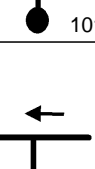

29 OUTUBRO 2022		Pág: 007	
FINAL DESLOCAMENTO			
7.08 0.00		15	00.20.09
		15	00.20.36
		15	00.21.14
V	T10		
0.05		15	
		15	
		15	00.21.26
V	T10		
0.10		15	
		15	
		15	00.21.38
V	T10		
AÇUDE			
0.12		15	
		15	
		15	00.21.42
V	T10		
AÇUDE			
0.16		39	00.20.48
		36	00.21.14
		33	00.21.52
V	T11		
0.23		39	
		36	
		33	00.22.00
V	T11		
0.80		39	
		36	
		33	00.23.02
V	T11		
0.83		39	
		36	
		33	00.23.05
V	T11		

29 OUTUBRO 2022		Pág: 008	
0.92		39	
		36	
		33	00.23.15
V	T11		
1.24		3'	00.22.27
		3'	00.23.02
		3'	00.23.50
N	T12		
1.24		39	00.25.27
		36	00.26.02
		33	00.26.50
V	T13		
1.47		39	
		36	
		33	00.27.15
V	T13		
1.49		39	
		36	
		33	00.27.17
V	T13		
1.53		33	00.25.54
		30	00.26.31
		27	00.27.22
V	T14		
1.69		33	
		30	
		27	00.27.43
V	T14		
1.79		39	00.26.23
		36	00.27.03
		33	00.27.56
V	T15		
1.81		39	
		36	
		33	00.27.58
V	T15		
1.85		39	
		36	
		33	00.28.03
V	T15		
1.89		39	
		36	
		33	00.28.07
V	T15		

29 OUTUBRO 2022		Pág: 009	
1.95		30	00.26.37
		27	00.27.19
		24	00.28.14
V	T16		
2.26		39	00.27.14
		36	00.28.00
		33	00.29.00
V	T17		
2.36		39	
		36	
		33	00.29.11
V	T17		
2.58		39	
		36	
		33	00.29.35
V	T17		
2.60		39	
		36	
		33	00.29.37
V	T17		
2.65		39	
		36	
		33	00.29.43
V	T17		
2.69		39	
		36	
		33	00.29.47
V	T17		
2.75		39	
		36	
		33	00.29.54
V	T17		
3.05		39	
		36	
		33	00.30.26
V	T17		
3.10		30	00.28.32
		27	00.29.24
		21	00.30.32
V	T18		
3.20		36	00.28.44
		33	00.29.37
		30	00.30.49
V	T19		

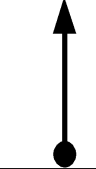
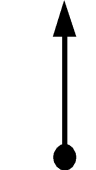
29 OUTUBRO 2022		Pág: 010	
3.28		36 33 30 00.30.58	V T19
3.30		36 33 30 00.31.01	V T19
3.46		36 33 30 00.31.20	V T19
3.60		36 33 30 00.31.37	V T19
3.68		36 33 30 00.31.46	V T19
3.71		39 00.29.35 36 00.30.33 33 00.31.50	V T20
3.85		39 36 33 00.32.05	V T20
3.96		39 36 33 00.32.17	V T20
4.00		39 36 33 00.32.22	V T20
4.25		39 36 33 00.32.49	V T20
4.32		39 36 33 00.32.57	V T20







29 OUTUBRO 2022		Pág: 011	
4.48		39 36 33 00.33.14	V T20
4.64		39 36 33 00.33.32	V T20
4.74		39 36 33 00.33.42	V T20
4.97		39 36 33 00.34.08	V T20
4.99		39 36 33 00.34.10	V T20
5.03		39 36 33 00.34.14	V T20
5.07		27 00.31.41 24 00.32.49 21 00.34.18	V T21
CUIDADO			
5.13		27 24 21 00.34.29	V T21
5.17		27 24 21 00.34.36	V T21
5.27		39 00.32.07 36 00.33.19 33 00.34.53	V T22



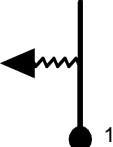

29 OUTUBRO 2022		Pág: 012	
5.30		39 36 33 00.34.56	V T22
5.71		2'30s 00.32.48 2'30s 00.34.03 2'30s 00.35.41	N T23
5.71		27 00.35.18 24 00.36.33 21 00.38.11	V T24
5.81		27 24 21 00.38.28	V T24
6.00		33 00.35.56 30 00.37.16 27 00.39.00	V T25
6.40		36 00.36.40 33 00.38.04 30 00.39.54	V T26
6.84		33 00.37.24 30 00.38.52 27 00.40.47	V T27
ATENÇÃO TRONCO			
CABEÇA			
7.01		24 00.37.43 21 00.39.13 18 00.41.09	V T28
7.19		30s 00.38.10 30s 00.39.44 30s 00.41.45	N T29
7.19		57 00.38.40 54 00.40.14 51 00.42.15	V T30



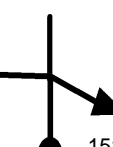
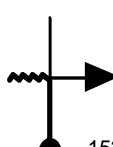
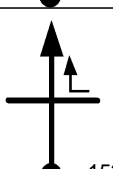

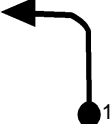
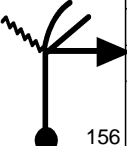
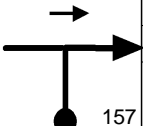

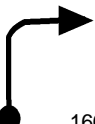
29 OUTUBRO 2022		Pág: 013	
7.44		57	
		54	
		51	00.42.33
		V	T30
7.76		57	
		54	
		51	00.42.55
		V	T30
7.84		57	
		54	
		51	00.43.01
		V	T30
7.87		36	00.39.23
		33	00.40.59
		30	00.43.03
		V	T31
7.98		36	
		33	
		30	00.43.16
		V	T31
8.01		36	
		33	
		30	00.43.20
		V	T31
8.08		36	
		33	
		30	00.43.28
		V	T31
8.12		36	
		33	
		30	00.43.33
		V	T31
8.21		36	
		33	
		30	00.43.44
		V	T31

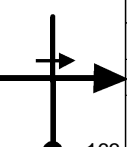
29 OUTUBRO 2022		Pág: 014	
8.27		27	00.40.03
		24	00.41.43
		21	00.43.51
		V	T32
8.33		27	
		24	
		21	00.44.02
		V	T32
8.41		27	
		24	
		21	00.44.15
		V	T32
8.46		27	
		24	
		21	00.44.24
		V	T32
8.51		27	
		24	
		21	00.44.32
		V	T32
8.57		36	00.40.43
		33	00.42.28
		30	00.44.43
		V	T33
8.65		36	
		33	
		30	00.44.52
		V	T33
8.67		36	
		33	
		30	00.44.55
		V	T33
8.77		36	
		33	
		30	00.45.07
		V	T33
8.87		36	
		33	
		30	00.45.19
		V	T33
9.00		36	
		33	
		30	00.45.34
		V	T33

29 OUTUBRO 2022		Pág: 015	
9.02		27	00.41.28
		24	00.43.17
		21	00.45.37
		V	T34
9.13		36	00.41.42
		33	00.43.33
		30	00.45.56
		V	T35
9.34		45	00.42.03
		42	00.43.56
		39	00.46.21
		V	T36
9.38		45	
		42	
		39	00.46.24
		V	T36
9.55		45	
		42	
		39	00.46.40
		V	T36
10.01		2'	00.42.57
		2'	00.44.53
		2'	00.47.23
		N	T37
10.01		57	00.44.57
		54	00.46.53
		51	00.49.23
		0.00	T38
0.32		57	
		54	
		51	00.49.45
		V	T38
0.42		57	
		54	
		51	00.49.52
		V	T38
1.31		57	
		54	
		51	00.50.55
		V	T38
1.34		57	
		54	
		51	00.50.57
		V	T38

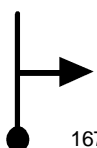
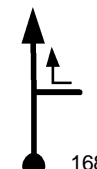
29 OUTUBRO 2022		Pág: 016	
1.49		30s 00.46.31	
		30s 00.48.33	
		30s 00.51.08	
N T39			
PERIGO MORTE			
1.49		18 00.47.01	
		15 00.49.03	
		15 00.51.38	
V T40			
2.20		36 00.49.23	
		33 00.51.53	
		30 00.54.28	
V T41			
2.30		36	
		33	
		30 00.54.40	
V T41			
2.31		36	
		33	
		30 00.54.41	
V T41			
2.33		36	
		33	
		30 00.54.44	
V T41			
2.40		36	
		33	
		30 00.54.52	
V T41			
3.00		39 00.50.43	
		36 00.53.20	
		33 00.56.04	
V T42			
3.76		39	
		36	
		33 00.57.27	
V T42			
3.92		39	
		36	
		33 00.57.44	
V T42			

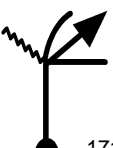
29 OUTUBRO 2022		Pág: 017	
PERIGO			
4.20		39	
		36	
		33 00.58.15	
V T42			
4.25		39	
		36	
		33 00.58.20	
V T42			
4.30		27 00.52.43	
		24 00.55.30	
		21 00.58.26	
V T43			
4.47		27	
		24	
		21 00.58.55	
V T43			
4.59		27	
		24	
		21 00.59.16	
V T43			
BAMP			
4.82		33 00.53.52	
		30 00.56.48	
		27 00.59.55	
V T44			
5.09		33	
		30	
		27 01.00.31	
V T44			
COSTEAR ROÇA			
5.18		33	
		30	
		27 01.00.43	
V T44			
5.31		1' 00.54.46	
		1' 00.57.47	
		1' 01.01.00	
N T45			
5.31		39 00.55.46	
		36 00.58.47	
		33 01.02.00	
V T46			

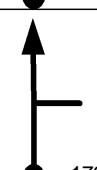
29 OUTUBRO 2022		Pág: 018	
PERIGO			
5.59		39	
		36	
		33 01.02.31	
V T46			
5.69		39	
		36	
		33 01.02.42	
V T46			
5.73		39	
		36	
		33 01.02.46	
V T46			
5.93		27 00.56.43	
		24 00.59.49	
		21 01.03.08	
V T47			
6.07		27	
		24	
		21 01.03.32	
V T47			
6.20		27	
		24	
		21 01.03.54	
V T47			
CUIDADO			
MOTO			
6.26		39 00.57.27	
		36 01.00.39	
		33 01.04.05	
V T48			
6.38		39	
		36	
		33 01.04.18	
V T48			
6.41		39	
		36	
		33 01.04.21	
V T48			
6.61		27 00.57.59	
		24 01.01.14	
		21 01.04.43	
V T49			

6.94		2'	00.58.43
		2'	01.02.03
		2'	01.05.39
		N	T50

6.94		27	01.00.43
		24	01.04.03
		21	01.07.39
		V	T51

6.96		27	
		24	
		21	01.07.43
		V	T51

PELA DIREITA

7.22		27	
		24	
		21	01.08.27
		V	T51

7.74		27	
		24	
		21	01.09.56
		V	T51

7.85		39	01.02.45
		36	01.06.20
		33	01.10.15
		V	T52



7.87		39	
		36	
		33	01.10.18
		V	T52

CUIDADO EROSAO

8.16		33	01.03.13
		30	01.06.51
		27	01.10.49
		V	T53

8.36		33	
		30	
		27	01.11.16
		V	T53

8.38		33	
		30	
		27	01.11.18
		V	T53

8.51		33	
		30	
		27	01.11.36
		V	T53

8.71		33	
		30	
		27	01.12.02
		V	T53

EROSAÇÃO

8.84		33	
		30	
		27	01.12.20
		V	T53

9.03		33	
		30	
		27	01.12.45
		V	T53

9.06		33	
		30	
		27	01.12.49
		V	T53

9.13		33	
		30	
		27	01.12.58
		V	T53

9.50		33	
		30	
		27	01.13.48
		V	T53

APOIO

FINAL PRIMEIRA ETAPA

9.54		15'	01.05.44
		15'	01.09.36
		15'	01.13.53
		N	T54

INICIO SEGUNDA ETAPA

9.54		18	01.20.44
		18	01.24.36
		18	01.28.53
0.00		V	T55

0.07		18	
		18	
		18	01.29.07
		V	T55

0.14		57	01.21.12
		54	01.25.04
		51	01.29.21
		V	T56

0.43		57	
		54	
		51	01.29.42
		V	T56

1.00		57	
		54	
		51	01.30.22
		V	T56

1.98		57	
		54	
		51	01.31.31
		V	T56

RIO



2.02		57	
		54	
		51	01.31.34
		V	T56



2.17		57	
		54	
		51	01.31.44
		V	T56

2.22		42	01.23.23
		39	01.27.23
		36	01.31.48
		V	T57

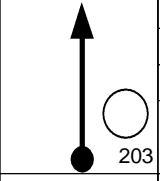
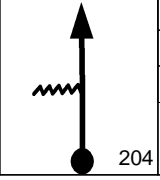
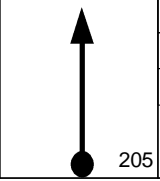
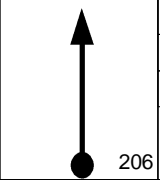
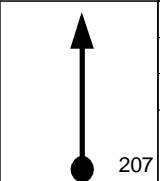
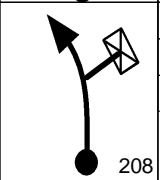
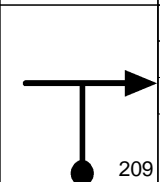
2.31		42	
		39	
		36	01.31.57
		V	T57

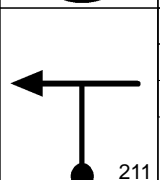
2.43		42	
		39	
		36	01.32.09
		V	T57

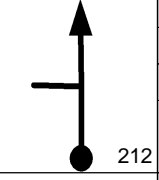
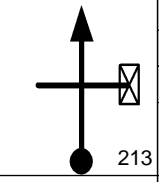
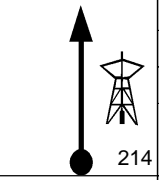
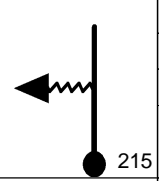
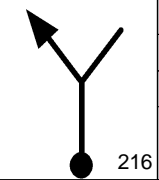
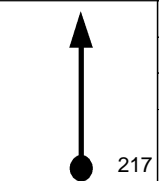
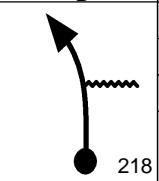
29 OUTUBRO 2022		Pág: 022	
CUIDADO			
PEDRA			
2.87		36 01.24.19	
		33 01.28.23	
		30 01.32.53	
	V	T58	
3.22		36	
		33	
		30 01.33.35	
	V	T58	
PELA ESQUERDA			
3.28		36	
		33	
		30 01.33.42	
	V	T58	
PELA ESQUERDA			
3.41		36	
		33	
		30 01.33.58	
	V	T58	
PELA ESQUERDA			
3.49		36	
		33	
		30 01.34.07	
	V	T58	
4.08		36	
		33	
		30 01.35.18	
	V	T58	
4.20		36	
		33	
		30 01.35.33	
	V	T58	
4.34		2' 01.26.46	
		2' 01.31.03	
		2' 01.35.49	
	N	T59	
4.34		39 01.28.46	
		39 01.33.03	
		39 01.37.49	
	V	T60	

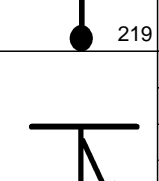
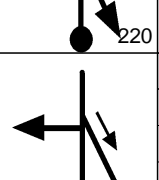
29 OUTUBRO 2022		Pág: 023	
5.06		39	
		39	
		39 01.38.56	
	V	T60	
5.18		39	
		39	
		39 01.39.07	
	V	T60	
6.07		39	
		39	
		39 01.40.29	
	V	T60	
6.33		30 01.31.50	
		27 01.36.07	
		24 01.40.53	
	V	T61	
6.40		30	
		27	
		24 01.41.04	
	V	T61	
6.83		36 01.32.50	
		33 01.37.14	
		30 01.42.08	
	V	T62	
7.44		39 01.33.51	
		36 01.38.20	
		33 01.43.21	
	V	T63	
NÃO ERRE			
7.46		39	
		36	
		33 01.43.23	
	V	T63	
7.65		27 01.34.10	
		24 01.38.41	
		21 01.43.44	
	V	T64	
7.83		39 01.34.34	
		36 01.39.08	
		33 01.44.15	
	V	T65	

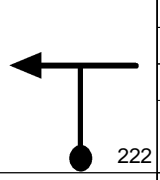
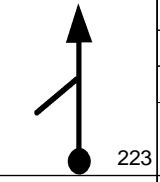
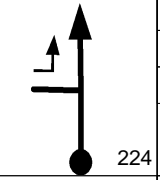
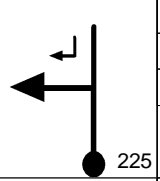
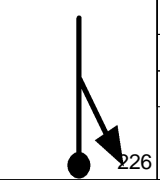
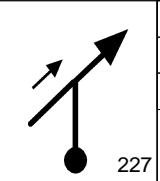
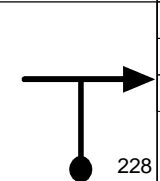
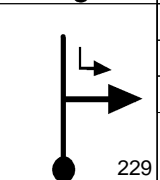
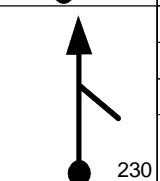
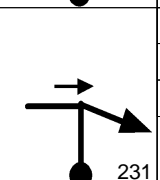
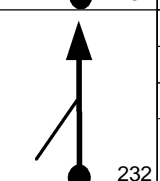
29 OUTUBRO 2022		Pág: 024	
7.97		39	
		36	
		33 01.44.30	
	V	T65	
8.13		39	
		36	
		33 01.44.48	
	V	T65	
8.19		39	
		36	
		33 01.44.54	
	V	T65	
8.47		39	
		36	
		33 01.45.25	
	V	T65	
8.54		39	
		36	
		33 01.45.32	
	V	T65	
8.69		39	
		36	
		33 01.45.49	
	V	T65	
8.71		39	
		36	
		33 01.45.51	
	V	T65	
8.83		39	
		36	
		33 01.46.04	
	V	T65	
8.91		39	
		36	
		33 01.46.13	
	V	T65	
9.14		30 01.36.35	
		27 01.41.19	
		24 01.46.38	
	V	T66	
9.18		30	
		27	
		24 01.46.44	
	V	T66	



29 OUTUBRO 2022		Pág: 025	
9.54		39 01.37.23 36 01.42.13 33 01.47.38	V T67
9.56		39 36 33 01.47.40	V T67
9.68		39 36 33 01.47.53	V T67
9.76		39 36 33 01.48.02	V T67
9.99		39 36 33 01.48.27	V T67
10.02		39 01.38.07 36 01.43.01 33 01.48.30	V T68
0.00			V T68
0.27		39 36 33 01.49.00	V T68
0.34		39 36 33 01.49.07	V T68
0.48		39 36 33 01.49.23	V T68



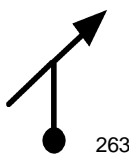
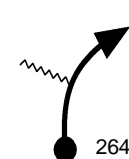
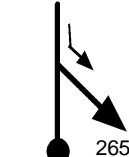
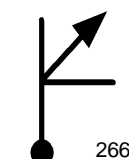
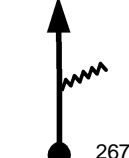
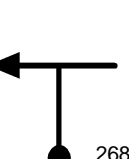
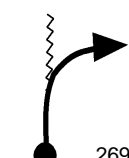
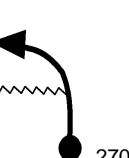
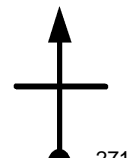
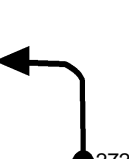

29 OUTUBRO 2022		Pág: 026	
0.51		39 36 33 01.49.26	V T68
0.55		39 36 33 01.49.30	V T68
0.58		21 01.39.01 18 01.43.59 15 01.49.34	V T69
0.62		21 18 15 01.49.43	V T69
0.64		21 18 15 01.49.48	V T69
0.70		2'30s 01.39.21 2'30s 01.44.23 2'30s 01.50.02	N T70
0.70		21 01.41.51 18 01.46.53 15 01.52.32	V T71
CUIDADO			
VALO			
1.14		21 18 15 01.54.18	V T71
1.23		39 01.43.22 36 01.48.39 33 01.54.40	V T72
1.40		39 36 33 01.54.58	V T72

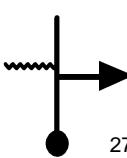
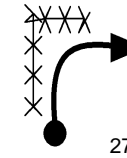
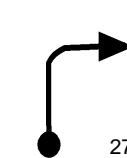
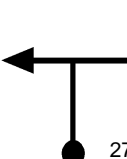
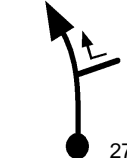
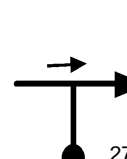
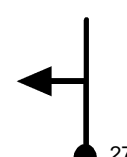
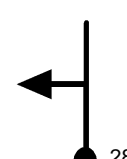
29 OUTUBRO 2022		Pág: 027	
1.67		39 36 33 01.55.28	V T72
1.79		39 36 33 01.55.41	V T72
1.99		36 01.44.32 36 01.49.55 36 01.56.02	V T73
2.08		36 36 36 01.56.11	V T73
2.12		36 36 36 01.56.15	V T73
2.48		36 45 01.45.21 42 01.50.44 39 01.56.51	V T74
2.57		45 42 39 01.57.00	V T74
2.66		45 42 39 01.57.08	V T74
2.87		45 42 39 01.57.27	V T74
2.97		45 42 39 01.57.37	V T74
3.30		30s 01.46.27 30s 01.51.54 30s 01.58.07	N T75

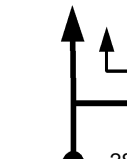
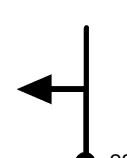
CUIDADO

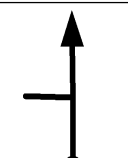
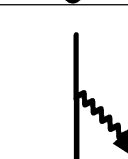
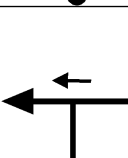
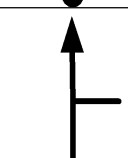
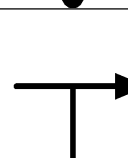
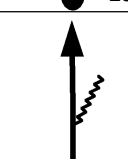
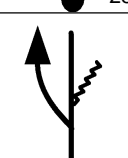
3.30		39 01.46.57	
		36 01.52.24	
		33 01.58.37	
		V	T76
3.61		39	
		36	
		33 01.59.11	
		V	T76
4.13		39	
		36	
		33 02.00.08	
		V	T76
4.49		45 01.48.47	
		42 01.54.23	
		39 02.00.47	
		V	T77
4.68		45	
		42	
		39 02.01.04	
		V	T77
4.88		45	
		42	
		39 02.01.23	
		V	T77
4.89		39 01.49.19	
		36 01.54.57	
		33 02.01.24	
		V	T78
5.08		39	
		36	
		33 02.01.45	
		V	T78
5.28		39	
		36	
		33 02.02.06	
		V	T78
5.34		39	
		36	
		33 02.02.13	
		V	T78

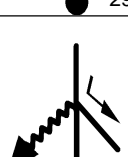
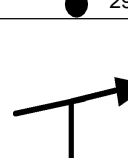









5.39		39	
		36	
		33 02.02.18	
		V	T78
5.45		39	
		36	
		33 02.02.25	
		V	T78
5.61		39	
		36	
		33 02.02.42	
		V	T78
5.78		48 01.50.41	
		45 01.56.26	
		42 02.03.01	
		V	T79
6.03		48	
		45	
		42 02.03.22	
		V	T79
6.18		48	
		45	
		42 02.03.35	
		V	T79
6.20		39 01.51.12	
		36 01.57.00	
		33 02.03.37	
		V	T80
6.23		39	
		36	
		33 02.03.40	
		V	T80
6.35		39	
		36	
		33 02.03.53	
		V	T80
6.44		39	
		36	
		33 02.04.03	
		V	T80
6.47		39	
		36	
		33 02.04.06	
		V	T80



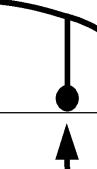

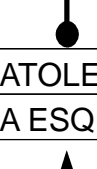

6.49		39	
		36	
		33 02.04.09	
		V	T80
6.61		39	
		36	
		33 02.04.22	
		V	T80
6.77		39	
		36	
		33 02.04.39	
		V	T80
6.80		39	
		36	
		33 02.04.42	
		V	T80
6.82		56 01.52.10	
		53 01.58.02	
		50 02.04.45	
		V	T81
6.91		56	
		53	
		50 02.04.51	
		V	T81
7.36		39 01.52.44	
		36 01.58.38	
		33 02.05.23	
		V	T82
7.56		39	
		36	
		33 02.05.45	
		V	T82
7.74 0.00		33 01.53.19	
		30 01.59.16	
		27 02.06.05	
		V	T83
0.17		33	
		30	
		27 02.06.28	
		V	T83
0.24		33	
		30	
		27 02.06.37	
		V	T83



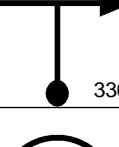

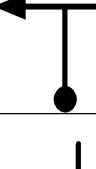
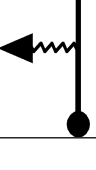
29 OUTUBRO 2022		Pág: 031	
0.38		33	
		30	
		27	02.06.56
		V	T83
0.42		33	
		30	
		27	02.07.01
		V	T83
0.77		48	01.54.43
		45	02.00.49
		42	02.07.48
		V	T84
0.85		48	
		45	
		42	02.07.54
		V	T84
1.01		48	
		45	
		42	02.08.08
		V	T84
1.16		48	
		45	
		42	02.08.21
		V	T84
1.18		48	
		45	
		42	02.08.23
		V	T84
1.27		48	
		45	
		42	02.08.30
		V	T84
1.30		48	
		45	
		42	02.08.33
		V	T84

29 OUTUBRO 2022		Pág: 032	
1.33		2'30s	01.55.25
		2'30s	02.01.34
		2'30s	02.08.36
		N	T85
1.33		33	01.57.55
		30	02.04.04
		27	02.11.06
		V	T86
1.38		33	
		30	
		27	02.11.12
		V	T86
1.40		33	
		30	
		27	02.11.15
		V	T86
1.54		33	
		30	
		27	02.11.34
		V	T86
1.85		39	01.58.52
		36	02.05.06
		33	02.12.15
		V	T87
2.30		42	01.59.34
		39	02.05.51
		36	02.13.04
		V	T88
2.36		42	
		39	
		36	02.13.10
		V	T88
2.50		42	
		39	
		36	02.13.24
		V	T88
2.66		42	
		39	
		36	02.13.40
		V	T88
2.75		42	
		39	
		36	02.13.49
		V	T88

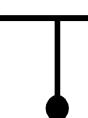
29 OUTUBRO 2022		Pág: 033	
2.78		42	
		39	
		36	02.13.52
		V	T88
2.87		42	
		39	
		36	02.14.01
		V	T88
2.96		42	
		39	
		36	02.14.10
		V	T88
2.98		48	02.00.32
		45	02.06.54
		42	02.14.12
		V	T89
3.03		48	
		45	
		42	02.14.16
		V	T89
3.08		48	
		45	
		42	02.14.21
		V	T89
3.44		27	02.01.06
		30	02.07.31
		30	02.14.51
		V	T90
3.54		30s	02.01.20
		30s	02.07.43
		30s	02.15.03
		N	T91
CUIDADO			
3.54		27	02.01.50
		27	02.08.13
		27	02.15.33
		V	T92
3.74		45	02.02.16
		42	02.08.39
		49	02.16.00
		V	T93

29 OUTUBRO 2022		Pág: 034	
3.88		45 42 49 02.16.10	V T93
4.07		45 42 49 02.16.24	V T93
4.12		45 42 49 02.16.28	V T93
4.43		45 42 49 02.16.51	V T93
4.54		45 42 49 02.16.59	V T93
4.67		45 42 49 02.17.08	V T93
4.99		33 02.03.56 30 02.10.26 27 02.17.32	V T94
0.00			V T94
ATOLEIRO			
PELA ESQUERDA			
0.20		33 30 27 02.17.59	V T94
0.28		33 30 27 02.18.09	V T94
0.57		33 30 27 02.18.48	V T94

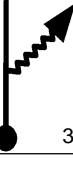
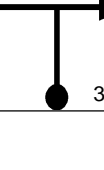
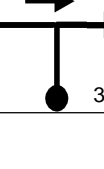
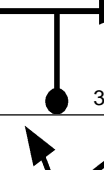
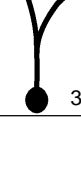
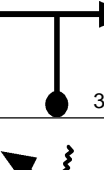
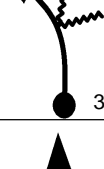
29 OUTUBRO 2022		Pág: 035	
0.81		33 30 27 02.19.20	V T94
0.84		36 02.05.28 39 02.12.07 39 02.19.24	V T95
1.00		3' 02.05.44 3' 02.12.22 3' 02.19.39	N T96
1.00		36 02.08.44 39 02.15.22 39 02.22.39	V T97
CUIDADO			
PERIGO			
2.35		36 39 39 02.24.43	V T97
3.13		39 02.12.17 36 02.18.39 33 02.25.55	V T98
3.20		39 36 33 02.26.03	V T98
3.28		39 36 33 02.26.12	V T98
3.40		39 36 33 02.26.25	V T98
3.41		39 36 33 02.26.26	V T98

29 OUTUBRO 2022		Pág: 036	
3.60		39 36 33 02.26.47	V T98
3.74		39 36 33 02.27.02	V T98
3.86		39 36 33 02.27.15	V T98
3.90		39 36 33 02.27.19	V T98
3.98		39 36 33 02.27.28	V T98
4.00		39 36 33 02.27.30	V T98
4.18		39 36 33 02.27.50	V T98
4.82		42 02.14.53 42 02.21.28 42 02.29.00	V T99
4.89		42 42 42 02.29.06	V T99
4.94		42 42 42 02.29.10	V T99
4.98		42 42 42 02.29.13	V T99

5.52		2'	02.15.53
		2'	02.22.28
		2'	02.30.00
		N	T100

CUIDADO

PERIGO

5.52		42	02.17.53
		42	02.24.28
		42	02.32.00
		V	T101

5.80		42	
		42	
		42	02.32.24
V	T101		

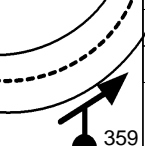
6.30		42	
		42	
		42	02.33.06
V	T101		



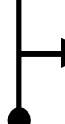

6.72		42	
		42	
		42	02.33.42
V	T101		

6.74		42	
		42	
		42	02.33.44
V	T101		

6.87		42	
		42	
		42	02.33.55
V	T101		

6.99		36	02.19.59
		33	02.26.34
		30	02.34.06
V	T102		

7.43		36	
		33	
		30	02.34.58
		V	T102

7.46		36	
		33	
		30	02.35.02
		V	T102

INICIO DESLOCAMENTO

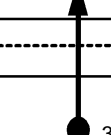
7.54		3'	02.20.54
		3'	02.27.34
		3'	02.35.12
		D	T103

FIM DESLOCAMENTO

BAMP

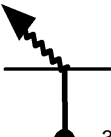
7.67		27	02.23.54
		24	02.30.34
		21	02.38.12
V	T104		

7.98		42	02.24.35
		39	02.31.20
		36	02.39.05
		V	T105

8.03		42	
		39	
		36	02.39.10
V	T105		

VALO

8.25		33	02.24.58
		30	02.31.45
		27	02.39.32
V	T106		

8.46		48	02.25.21
		45	02.32.10
		42	02.40.00
V	T107		

8.84		48	
		45	
		42	02.40.32
		V	T107

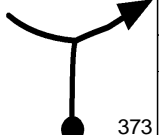
8.88		48	
		45	
		42	02.40.36
V	T107		

8.93		48	
		45	
		42	02.40.40
		V	T107

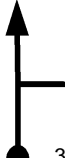
9.32		48	
		45	
		42	02.41.13
		V	T107

9.50		42	02.26.39
		39	02.33.33
		36	02.41.29
		V	T108

0.05		42	
		39	
		36	02.41.34
V	T108		

0.25		42	
		39	
		36	02.41.54
V	T108		

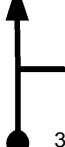
0.29		42	
		39	
		36	02.41.58
V	T108		

0.35		42	
		39	
		36	02.42.04
V	T108		



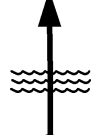



RIO

0.38		33	02.27.12
		30	02.34.08
		27	02.42.07
V	T109		

0.53		33	
		30	
		27	02.42.27
		V	T109

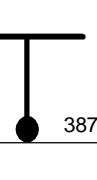
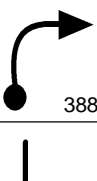
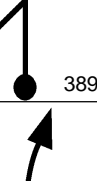
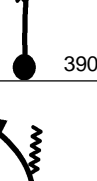
0.64		33	
		30	
		27	02.42.42
V	T109		

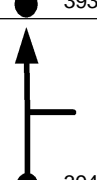
0.75		33	
		30	
		27	02.42.56
		V	T109

29 OUTUBRO 2022		Pág: 040	
0.90		42	02.28.09
		39	02.35.11
		36	02.43.16
		V	T110
1.24		42	
		39	
		36	02.43.50
		V	T110
1.53		48	02.29.03
		45	02.36.09
		42	02.44.19
		V	T111
1.82		48	
		45	
		42	02.44.44
		V	T111
2.21		48	
		45	
		42	02.45.18
		V	T111
2.24		48	
		45	
		42	02.45.20
		V	T111
2.42		48	
		45	
		42	02.45.36
		V	T111
2.66		48	
		45	
		42	02.45.56
		V	T111
2.72		48	
		45	
		42	02.46.01
		V	T111
2.78		48	
		45	
		42	02.46.06
		V	T111
3.11		48	
		45	
		42	02.46.35
		V	T111

29 OUTUBRO 2022		Pág: 041	
3.75		39	02.31.49
		42	02.39.07
		42	02.47.30
		V	T112
5.03		39	
		42	
		42	02.49.19
		V	T112
FIM DE PROVA			
5.36		0h	02.34.18
		0h	02.41.25
		0h	02.49.48
		N	T113
FIM DE PROVA !!			
			
www.t15.com.br			
Tempo de Prova			
MEDIA A 02:34:18			
MEDIA B 02:41:25			
MEDIA C 02:49:48			
FIM			