

INICIO

MÉDIA C

2ª ENDURO DO TAQUARI
22/07/2017



IMPORTANTE

☠	CUIDADO
☠☠	ATENÇÃO
☠☠☠	MUITA ATENÇÃO

Tempo de Prova

MÉDIA C 03:02:43



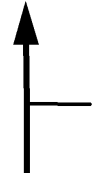

AFERIÇÃO

0.00	
AFER	1
0.10	
AFER	2
0.89	
AFER	3

1.05	
AFER	4

1.37	
AFER	5

1.48	
AFER	6





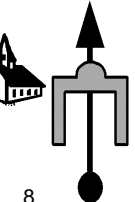

NO POSTE	
1.76	
AFER	7

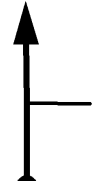

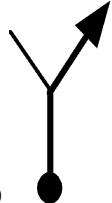
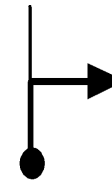
INICIO DE PROVA

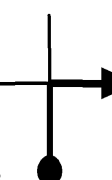
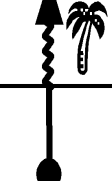
0.00	
V 39 00.00.00	
T1	8

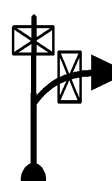
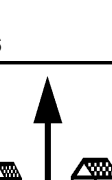
0.10	
V 39 00.00.09	
T1	9

0.89	
V 39 00.01.22	
T1	10
1.05	
V 33 00.01.37	
T2	11
1.39	
V 33 00.02.14	
T2	12
1.59	
V 27 00.02.36	
T3	13
1.86	
V 27 00.03.12	
T3	14
1.87	
V 21 00.03.13	
T4	15
1.98	
0.00	
V 21 00.03.32	
T5	16
0.06	
V 21 00.03.42	
T5	17

entre no mato

siga bamp

0.12



V 18 | 00.03.53

T6

18

0.25



V 27 | 00.04.19

T7

19

0.64

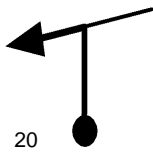

V 27 | 00.05.11

T7

20

0.67

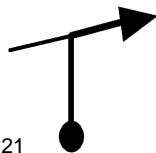

V 27 | 00.05.15

T7

21

baixe a cabeça

0.77



V 27 | 00.05.28

T7

22

1.04

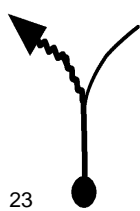

V 27 | 00.06.04

T7

23

1.16

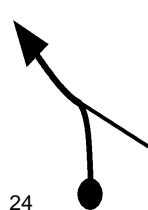

V 27 | 00.06.20

T7

24

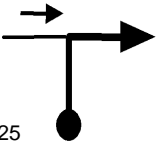
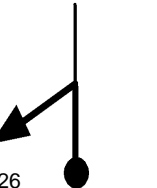
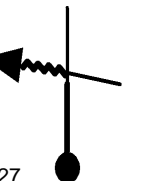
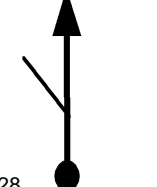
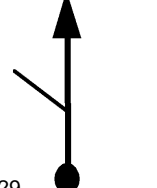
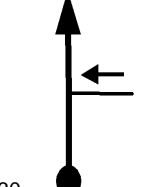
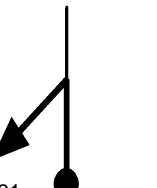
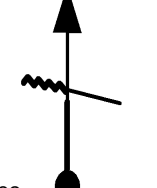
1.23	
V 30 00.06.29	
T8	25
1.29	
V 30 00.06.36	
T8	26
1.34	
V 30 00.06.42	
T8	27
1.36	
V 30 00.06.45	
T8	28
1.59	
V 30 00.07.12	
T8	29
1.64	
V 30 00.07.18	
T8	30
1.71	
V 30 00.07.27	
T8	31
1.76	
V 30 00.07.33	
T8	32

2.00		
V 30	00.08.02	
T8		

2.11		
V 30	00.08.15	
T8		

cuidado

2.24		
N 2'	00.08.30	
T9		

2.24		
V 30	00.10.30	
T10		







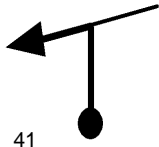

2.28		
V 30	00.10.35	
T10		

2.33		
V 30	00.10.41	
T10		

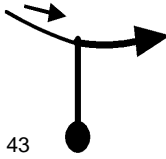
sigla bamp

2.43		
V 30	00.10.53	
T10		

2.44		
V 30	00.10.54	
T10		

2.52	
V 30 00.11.04	
T10	41
2.53	
V 30 00.11.05	
T10	42
2.59	
V 30 00.11.12	
T10	43
2.69	
V 30 00.11.24	
T10	44
2.84	
V 21 00.11.42	
T11	45
3.07	
V 30 00.12.22	
T12	46
3.16	
V 30 00.12.33	
T12	47
3.32	
V 30 00.12.52	
T12	48

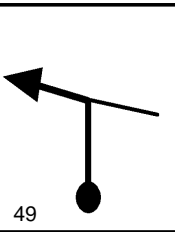
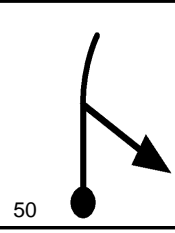
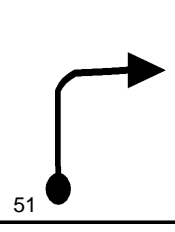
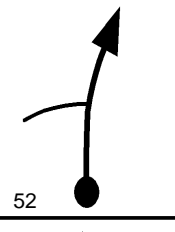
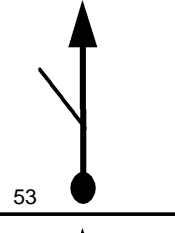
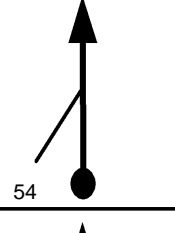
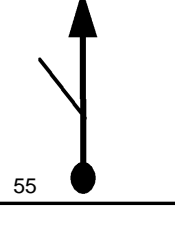
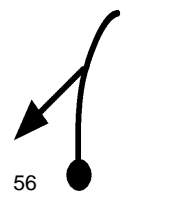
3.45	
V 30 00.13.07	
T12	49
3.55	
V 30 00.13.19	
T12	50
3.81	
V 30 00.13.51	
T12	51
4.28	
V 30 00.14.47	
T12	52
4.43	
V 30 00.15.05	
T12	53
4.55	
V 30 00.15.19	
T12	54
4.72	
V 30 00.15.40	
T12	55
4.80	
V 30 00.15.49	
T12	56

4.86		
V 30	00.15.57	
T12		

4.94		
V 30	00.16.06	
T12		

5.22		
V 30	00.16.40	
T12		



5.28		
V 30	00.16.47	
T12		

5.42		
V 30	00.17.04	
T12		

5.54		
V 30	00.17.18	
T12		

5.61		
V 30	00.17.27	
T12		

entre no mato

5.70

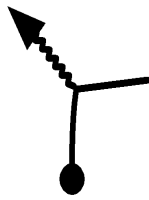

0.00

N 2' 00.17.37

T13

64

0.00



V 24 00.19.37

T14

65

0.16



V 24 00.20.01

T14

66

0.28

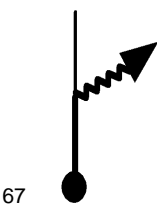

V 12 00.20.19

T15

67

0.32

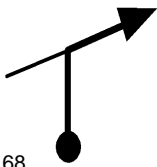

V 12 00.20.31

T15

68

0.38

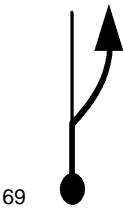

V 12 00.20.49

T15

69



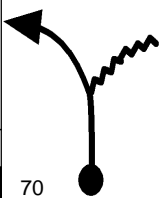

0.50

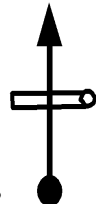
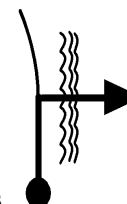
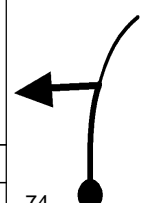

V 24 00.21.25

T16

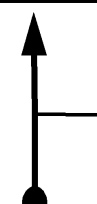
70

0.58		
V 24	00.21.37	
T16		71
BAIXE A CABEÇA		
0.72		
V 24	00.21.58	
T16		72
0.87		
V 24	00.22.21	
T16		73
0.92		
V 24	00.22.28	
T16		74
1.07		
V 24	00.22.51	
T16		75
1.13		
V 27	00.23.00	
T17		76
1.29		
V 27	00.23.21	
T17		77
1.37		
V 27	00.23.32	
T17		78

1.53		
V 27	00.23.53	
T17 79		

ENTRE NO MATO

1.59		
V 24	00.24.01	
T18 80		

1.82		
0.00		
V 18	00.24.36	
T19 81		

CUIDADO

PONTE ESTREITA







0.21		
V 12	00.25.18	
T20 82		



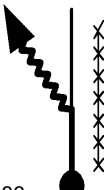

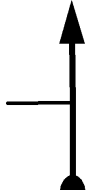
0.67		
V 12	00.27.36	
T20 83		

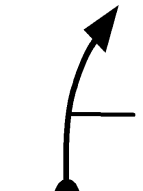
cuidado

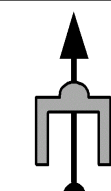
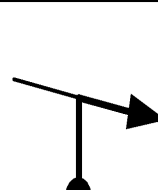
0.73		
V 12	00.27.54	
T20 84		

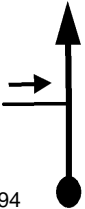
0.81		
V 12	00.28.18	
T20 85		

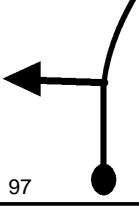
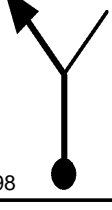
0.84	
V 30 00.28.27	
T21	86
1.04	
V 30 00.28.51	
T21	87
1.22	
N2'30s 00.29.12	
T22	88
1.22	
V 27 00.31.42	
T23	89
1.42	
V 27 00.32.09	
T23	90
1.47	
V 27 00.32.16	
T23	91
1.58	
V 27 00.32.30	
T23	92
1.61	
0.00	
V 39 00.32.34	
T24	93

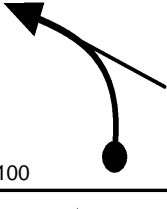
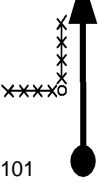
0.97	
V 39 00.34.04	94
T24	
2.18	
V 39 00.35.56	95
T24	
3.15	
V 39 00.37.25	96
T24	
3.91	
V 39 00.38.35	97
T24	
3.93	
V 27 00.38.37	98
T25	
4.12	
V 27 00.39.02	99
T25	
4.27	
V 33 00.39.22	100
T26	
4.48	
V 33 00.39.45	101
T26	

4.77		
V 33	00.40.17	
T26		

entre no mato

4.95		
V 27	00.40.37	
T27		

5.16		
V 27	00.41.05	
T27		

5.22		
N 1'	00.41.13	
T28		

5.22		
V 27	00.42.13	
T29		

5.28		
V 27	00.42.21	
T29		

5.35		
V 27	00.42.30	
T29		

5.38		
V 18	00.42.34	
T30		

5.48		
V 18	00.42.54	
T30 110		
cuidado degrau pedra		
PERIGO		
5.58		
V 18	00.43.14	
T30 111		
5.92		
V 18	00.44.22	
T30 112		
6.18		
V 18	00.45.14	
T30 113		
6.26		
V 27	00.45.30	
T31 114		
6.40		
N 2'	00.45.49	
T32 115		
6.40		
V 30	00.47.49	
T33 116		
6.68		
V 30	00.48.22	
T33 117		

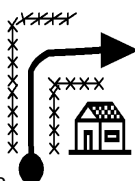
6.71	
V 18 00.48.26	
T34	118

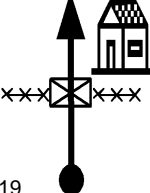
6.87	
V 24 00.48.58	
T35	119

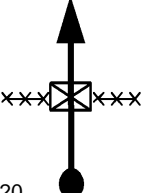

7.60	
V 39 00.50.47	
T36	120

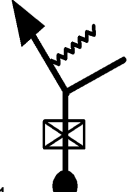

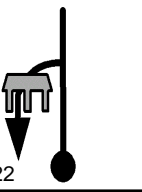

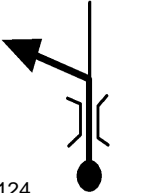

7.96	
V 39 00.51.21	
T36	121

8.74	
V 27 00.52.33	
T37	122

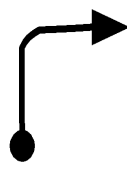
8.77	
V 27 00.52.37	
T37	123

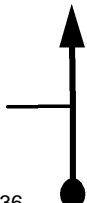
8.80	
V 27 00.52.41	
T37	124

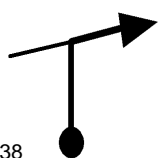
8.96	
V 30 00.53.02	
T38	125
9.01	
V 30 00.53.08	
T38	126
9.04	
V 30 00.53.12	
T38	127
9.40	
V 27 00.53.55	
T39	128
9.48	
V 27 00.54.05	
T39	129
9.74	
V 27 00.54.40	
T39	130
9.76	
V 30 00.54.43	
T40	131
9.90	
V 30 00.55.00	
T40	132

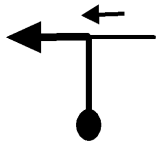
10.05	
V 30 00.55.18	
T40	133
10.09	
V 30 00.55.22	
T40	134
10.22	
V 30 00.55.38	
T40	135
10.27	
V 30 00.55.44	
T40	136
10.49	
V 30 00.56.10	
T40	137
10.51	
N1'30s 00.56.13	
T41	138
10.51	
V 39 00.57.43	
T42	139
10.78	
0.00	
V 39 00.58.08	
T43	140

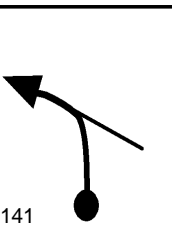
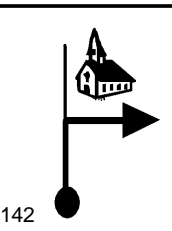
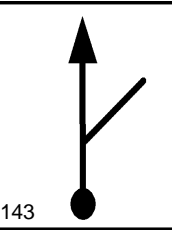
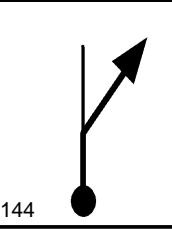
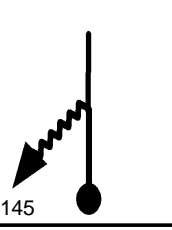
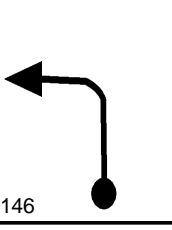
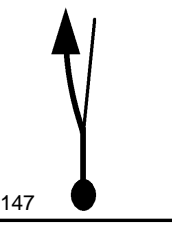
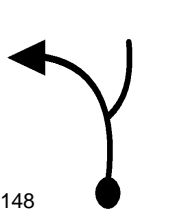
1.22	
V 39 01.00.00	
T43	141
2.17	
V 39 01.01.28	
T43	142
2.65	
V 39 01.02.12	
T43	143
2.90	
V 39 01.02.35	
T43	144
3.47	
V 30 01.03.28	
T44	145
3.94	
V 15 01.04.24	
T45	146
4.51	
V 15 01.06.41	
T45	147
4.53	
V 15 01.06.46	
T45	148

pelo rio	
4.61	
V 15	01.07.05
	T45 149
4.64	
V 15	01.07.12
	T45 150
saia do rio	
4.66	
V 21	01.07.17
	T46 151
4.96	
V 21	01.08.09
	T46 152
5.05	
V 21	01.08.24
	T46 153
5.09	
V 21	01.08.31
	T46 154
5.45	
N 2'	01.09.33
	T47 155
5.45	
V 39	01.11.33
	T48 156

5.96		
V 39	01.12.20	
T48 157		

7.08		
V 39	01.14.03	
T48 158		

7.44		
V 39	01.14.36	
T48 159		







7.88		
V 39	01.15.17	
T48 160		



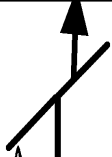

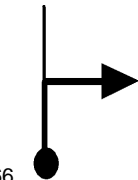
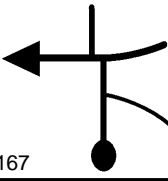
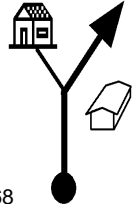
8.76		
V 39	01.16.38	
T48 161		

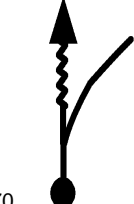
apoyo
zerar no poste

9.13		
0.00		
N 15'	01.17.12	
T49 162		

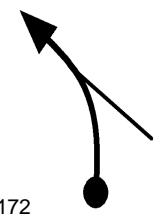
0.00		
V 39	01.32.12	
T50 163		

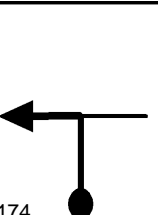
0.03	
V 39 01.32.15	
T50	164
0.88	
V 39 01.33.33	
T50	165
1.58	
V 27 01.34.38	
T51	166
2.17	
V 15 01.35.57	
T52	167
2.28	
V 34 01.36.23	
T53	168
2.49	
V 34 01.36.45	
T53	169
2.86	
V 34 01.37.25	
T53	170
RIO COM PEDRAS	
3.08	
V 15 01.37.48	
T54	171

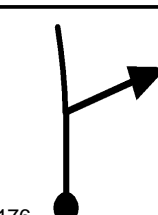
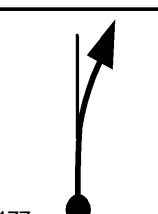
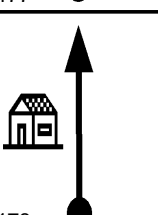
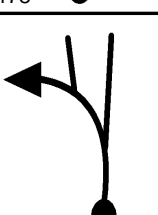
3.29	
V 24 01.38.38	
T55	172
3.41	
V 24 01.38.56	
T55	173
3.46	
N 2' 01.39.04	
T56	174
3.46	
V 39 01.41.04	
T57	175
3.87	
V 39 01.41.42	
T57	176
4.17	
V 18 01.42.09	
T58	177
4.26	
V 18 01.42.27	
T58	178
4.33	
V 24 01.42.41	
T59	179



4.45	
V 24 01.42.59	
T59	180

4.46	
V 21 01.43.01	
T60	181

4.52	
V 21 01.43.11	
T60	182

4.91	
V 15 01.44.18	
T61	183

5.19	
V 15 01.45.25	
T62	184

5.45	
V 15 01.46.28	
T62	185

5.49	
V 15 01.46.37	
T62	186

5.57	
N2'30s 01.46.56	
T63	187

5.57	
V 30 01.49.26	
T64	188

5.84	
V 30 01.49.59	
T64	189

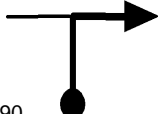
5.98	
V 42 01.50.16	
T65	190

6.71	
V 33 01.51.18	
T66	191



6.79	
V 33 01.51.27	
T66	192





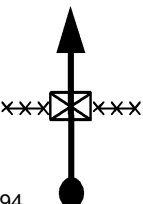

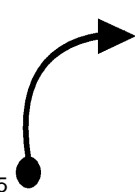

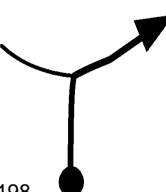
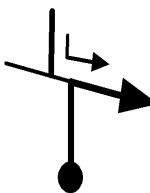
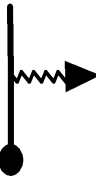
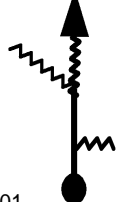
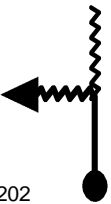
7.04	
V 33 01.51.54	
T66	193





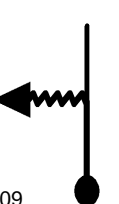

SUBIDA COM MUITA EROSÃO



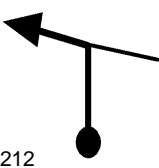



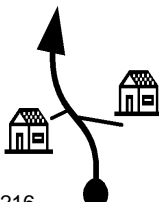

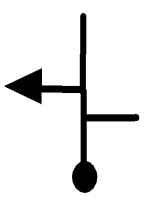
MUITO CUIDADO



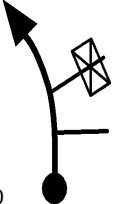
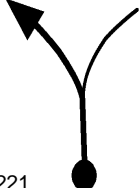
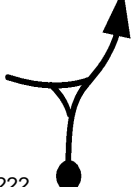



7.20	
V 15 01.52.12	
T67	194

7.50	
V 15 01.53.24	
T67	195
7.99	
N2'30s 01.55.21	
T68	196
7.99	
V 30 01.57.51	
T69	197
8.28	
V 39 01.58.26	
T70	198
9.27	
0.00	
V 39 01.59.57	
T71	199
0.13	
V 24 02.00.09	
T72	200
0.22	
V 12 02.00.23	
T73	201
0.38	
V 24 02.01.11	
T74	202

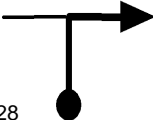
0.64	
V 30 02.01.50	
T75	203
0.88	
V 30 02.02.19	
T75	204
1.05	
V 30 02.02.39	
T75	205
1.33	
V 24 02.03.13	
T76	206
1.73	
V 30 02.04.13	
T77	207
2.02	
V 30 02.04.47	
T77	208
2.19	
V 12 02.05.08	
T78	209
2.31	
V 30 02.05.44	
T79	210

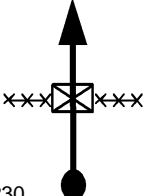
2.40	
V 30 02.05.55	
T79	211
2.75	
V 30 02.06.37	
T79	212
2.88	
N 2' 02.06.52	
T80	213
2.88	
V 27 02.08.52	
T81	214
2.94	
V 27 02.09.00	
T81	215
3.27	
V 39 02.09.44	
T82	216
3.77	
V 39 02.10.30	
T82	217
3.89	
0.00	
V 39 02.10.41	
T83	218

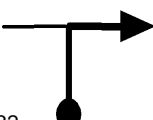
0.11		
V 39	02.10.52	
T83		219
0.77		
V 39	02.11.52	
T83		220
0.97		
V 36	02.12.11	
T84		221
1.43		
V 36	02.12.57	
T84		222
1.48		
V 36	02.13.02	
T84		223
1.84		
V 36	02.13.38	
T84		224
1.99		
V 33	02.13.53	
T85		225
2.08		
V 33	02.14.03	
T85		226

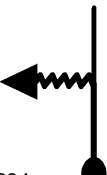
2.44	
V 33 02.14.42	
	T85 227
2.74	
V 33 02.15.15	
	T85 228
2.89	
V 27 02.15.31	
	T86 229
3.05	
V 27 02.15.52	
	T86 230
3.28	
V 27 02.16.23	
	T86 231
3.29	
N 2' 02.16.24	
	T87 232
3.29	
V 39 02.18.24	
	T88 233
3.81	
V 30 02.19.12	
	T89 234

4.45		
V 30	02.20.29	
T89 235		

4.60		
V 30	02.20.47	
T89 236		

4.74		
V 30	02.21.04	
T89 237		

CUIDADO PEDRA

4.76		
V 24	02.21.06	
T90 238		





CUIDADO TOCO



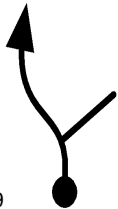

4.77		
V 30	02.21.08	
T91 239		



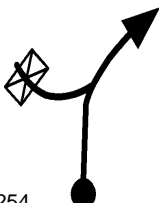
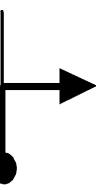
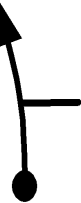

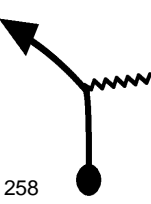
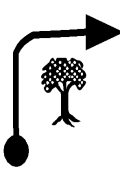

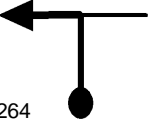

4.91		
V 30	02.21.25	
T91 240		

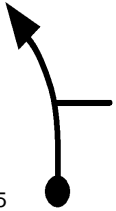
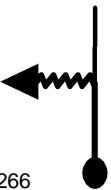

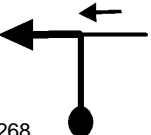
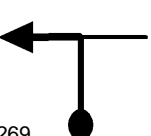
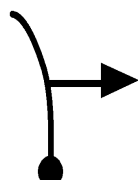

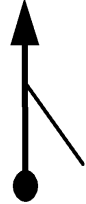
4.96	
V 30 02.21.31	
T91	241
5.06	
V 30 02.21.43	
T91	242
5.22	
V 30 02.22.02	
T91	243
5.30	
V 30 02.22.12	
T91	244
5.90	
V 30 02.23.24	
T91	245
5.96	
0.00	
V 30 02.23.31	
T92	246
0.15	
V 30 02.23.49	
T92	247
0.32	
V 30 02.24.09	
T92	248

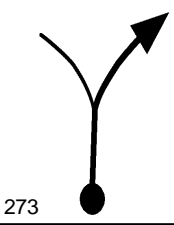
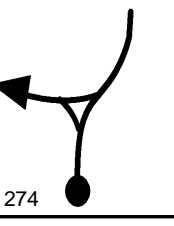
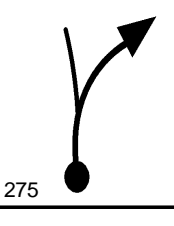
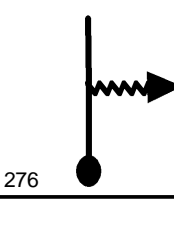
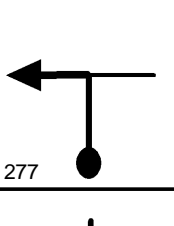
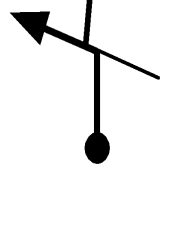
0.46	
V 30 02.24.26	
	T92 249
CUIDADO PEDRA	
0.49	
V 24 02.24.30	
	T93 250
CUIDADO TOCO	
0.50	
V 30 02.24.31	
	T94 251
0.63	
V 30 02.24.47	
	T94 252
0.68	
V 30 02.24.53	
	T94 253
0.78	
V 30 02.25.05	
	T94 254
0.95	
V 30 02.25.25	
	T94 255
1.02	
V 30 02.25.33	
	T94 256

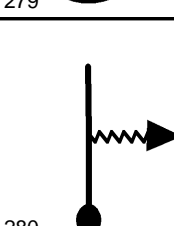
1.62	
V 30 02.26.45	
T94	257
1.68	
V 30 02.26.53	
T94	258
1.74	
V 30 02.27.00	
T94	259
1.84	
N 2' 02.27.12	
T95	260
1.84	
V 39 02.29.12	
T96	261
2.11	
V 39 02.29.37	
T96	262
2.17	
V 39 02.29.42	
T96	263
2.41	
V 39 02.30.04	
T96	264

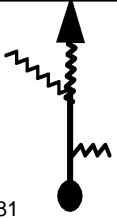
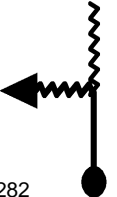
2.47	
V 39 02.30.10	
	T96 265
2.70	
V 30 02.30.31	
	T97 266
2.75	
V 30 02.30.37	
	T97 267
3.01	
V 39 02.31.08	
	T98 268
3.25	
V 39 02.31.31	
	T98 269
3.30	
N1'30s 02.31.35	
	T99 270
3.30	
V 39 02.33.05	
	T100 271
3.87	
V 39 02.33.58	
	T100 272

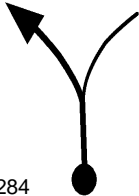
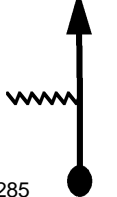
4.02	
V 36 02.34.12	
T101	273
4.47	
V 30 02.34.57	
T102	274
4.50	
V 30 02.35.00	
T102	275
4.72	
V 27 02.35.27	
T103	276
5.28	
V 33 02.36.41	
T104	277
6.10	
0.00	
N1'30s 02.38.11	
T105	278
0.00	
V 39 02.39.41	
T106	279
0.13	
V 24 02.39.53	
T107	280

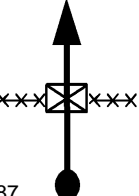
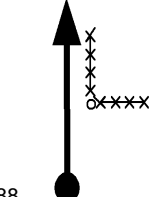
0.23	
V 12 02.40.08	
T108	281
0.39	
V 24 02.40.56	
T109	282
0.65	
0.00	
V 30 02.41.35	
T110	283
0.23	
V 30 02.42.02	
T110	284
0.40	
V 30 02.42.23	
T110	285
0.69	
V 30 02.42.58	
T110	286
1.20	
V 30 02.43.59	
T110	287
1.52	
N 2' 02.44.37	
T111	288

1.52	
V 30 02.46.37	
T112	289

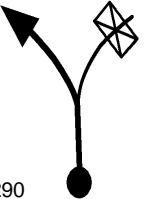
2.01	
V 30 02.47.36	
T112	290

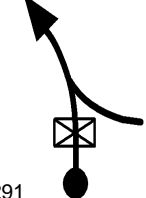
2.09	
V 39 02.47.46	
T113	291

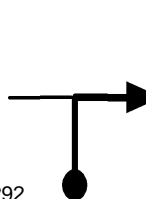
2.17	
V 39 02.47.53	
T113	292

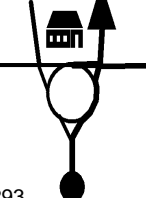
2.72	
V 39 02.48.44	
T113	293

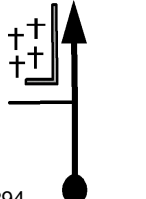
3.07	
V 30 02.49.16	
T114	294

CUIDADO DESCIDA COM EROSÕES

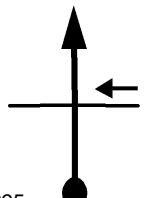
3.46	
V 27 02.50.03	
T115	295

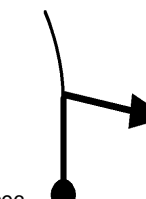
3.52	
V 27 02.50.11	
T115	296

3.60		
V 27	02.50.22	
T115 297		

3.76		
V 27	02.50.43	
T115 298		

3.82		
V 30	02.50.51	
T116 299		





3.96		
V 30	02.51.08	
T116 300		

4.01		
V 30	02.51.14	
T116 301		

4.07		
V 30	02.51.21	
T116 302		

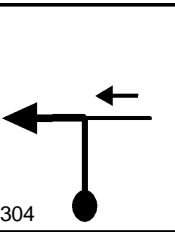
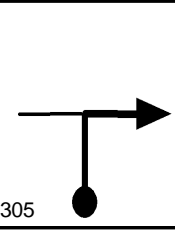
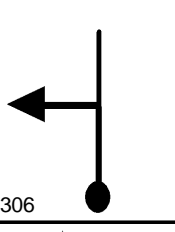
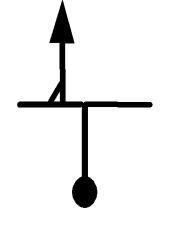
4.14		
V 30	02.51.29	
T116 303		

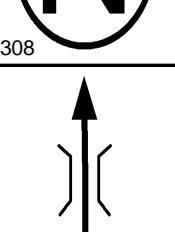
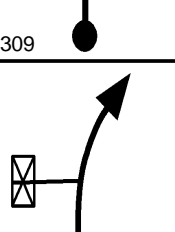
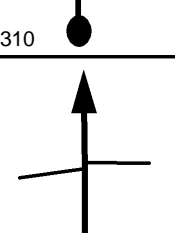
4.32	
V 30 02.51.51	
T116	304
4.38	
V 30 02.51.58	
T116	305
4.45	
V 30 02.52.06	
T116	306
4.58	
0.00	
N 2' 02.52.22	
T117	307
0.00	
V 42 02.54.22	
T118	308
0.44	
V 42 02.55.00	
T118	309
1.29	
V 42 02.56.13	
T118	310
2.84	
V 42 02.58.25	
T118	311

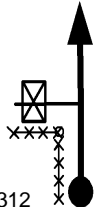
3.78	
V 42	02.59.46
T118 312	

4.88	
V 42	03.01.20
T118 313	

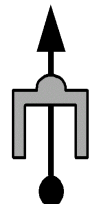
5.85	
V 42	03.02.43
T118 314	

FIM DE PROVA !!



www.t15.com.br

Tempo de Prova

MÉDIA C 03:02:43

FIM