

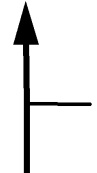

1.05	
AFER	4

1.37	
AFER	5

1.48	
AFER	6

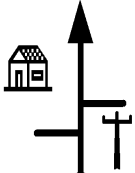

NO POSTE	
1.76	
AFER	7

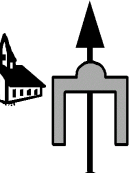

INICIO DE PROVA

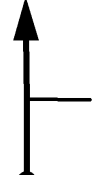
0.00	
V 39	00.00.00
T1	8

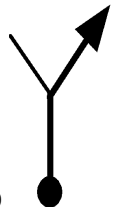
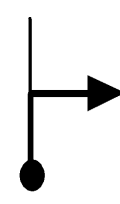
0.10	
V 39	
T1	9

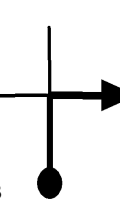
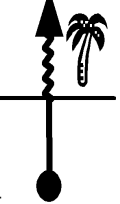
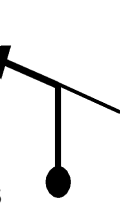
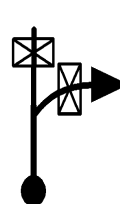
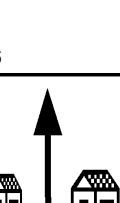
0.89		
V 39	T1 10	
1.05		
V 36	00.01.37 T2 11	
1.39		
V 36	T2 12	
1.59		
V 30	00.02.31 T3 13	
1.86		
V 30	T3 14	
1.87		
V 24	00.03.05 T4 15	
1.98		
0.00		
V 24	00.03.21 T5 16	
0.06		
V 24	T5 17	

entre no mato

siga bamp

0.12



V 21 | 00.03.39

T6

18

0.25



V 30 | 00.04.01

T7

19

0.64

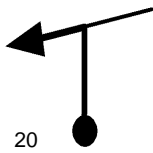

V 30

T7

20

0.67

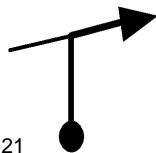

V 30

T7

21

baixe a cabeça

0.77



V 30

T7

22

1.04

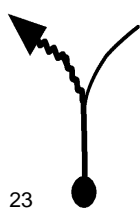

V 30

T7

23



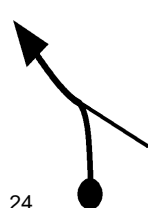

1.16

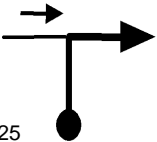

V 30

T7

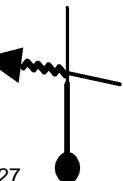
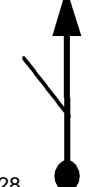
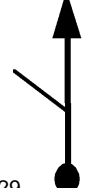
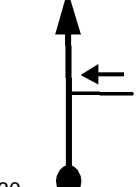
24

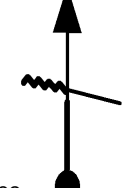
1.23	
V 33	00.05.59
	T8 25
1.29	
V 33	
	T8 26
1.34	
V 33	
	T8 27
1.36	
V 33	
	T8 28
1.59	
V 33	
	T8 29
1.64	
V 33	
	T8 30
1.71	
V 33	
	T8 31
1.76	
V 33	
	T8 32

2.00		
V 33		
	T8 33	

2.11		
V 33		
	T8 34	

cuidado

2.24		
N2'30s	00.07.49	
	T9 35	

2.24		
V 33	00.10.19	
	T10 36	

2.28		
V 33		
	T10 37	

2.33		
V 33		
	T10 38	

sigla bamp

2.43		
V 33		
	T10 39	

2.44		
V 33		
	T10 40	

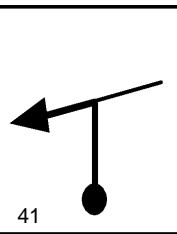
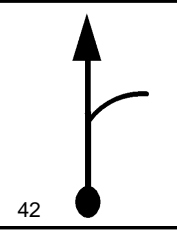
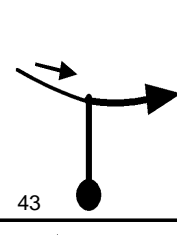
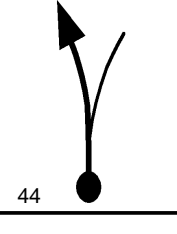
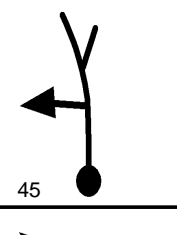
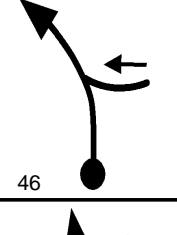
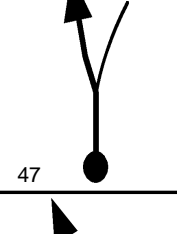
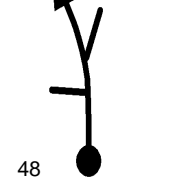
2.52	
V 33	
	T10 41
2.53	
V 33	
	T10 42
2.59	
V 33	
	T10 43
2.69	
V 33	
	T10 44
2.84	
V 24	00.11.25
	T11 45
3.07	
V 33	00.11.59
	T12 46
3.16	
V 33	
	T12 47
3.32	
V 33	
	T12 48

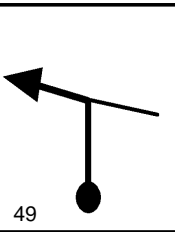
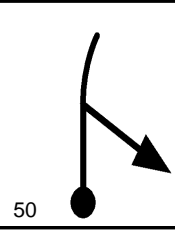
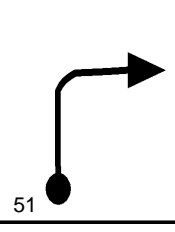
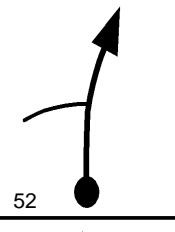
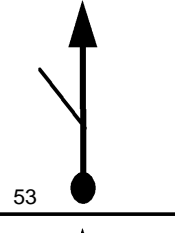
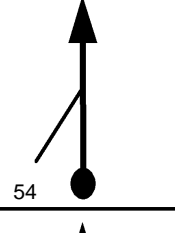
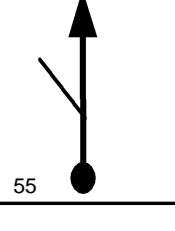
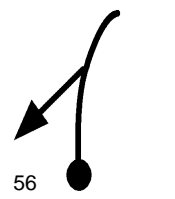
3.45	
V 33	
T12	49
3.55	
V 33	
T12	50
3.81	
V 33	
T12	51
4.28	
V 33	
T12	52
4.43	
V 33	
T12	53
4.55	
V 33	
T12	54
4.72	
V 33	
T12	55
4.80	
V 33	
T12	56

4.86		
V 33		
	T12 57	

4.94		
V 33		
	T12 58	

5.22		
V 33		
	T12 59	



5.28		
V 33		
	T12 60	

5.42		
V 33		
	T12 61	

5.54		
V 33		
	T12 62	

5.61		
V 33		
	T12 63	

entre no mato

5.70

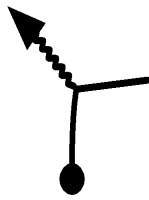

0.00

N2'30s 00.16.46

T13

64

0.00



V 27 00.19.16

T14

65

0.16



V 27

T14

66

0.28

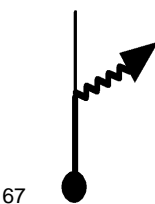

V 15 00.19.53

T15

67

0.32

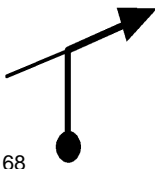

V 15

T15

68

0.38

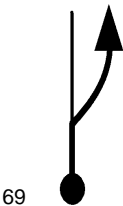

V 15

T15

69



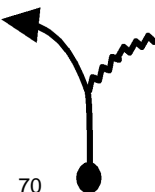

0.50

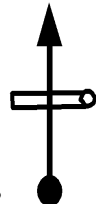
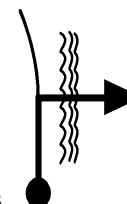
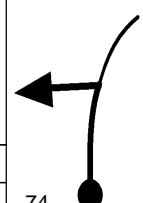

V 27 00.20.46

T16

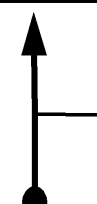
70

0.58		
V 27		
	T16	71
BAIXE A CABEÇA		
0.72		
V 27		
	T16	72
0.87		
V 27		
	T16	73
0.92		
V 27		
	T16	74
1.07		
V 27		
	T16	75
1.13		
V 30	00.22.10	
	T17	76
1.29		
V 30		
	T17	77
1.37		
V 30		
	T17	78

1.53		
V 30		
	T17 79	

ENTRE NO MATO

1.59		
V 27	00.23.05	
	T18 80	

1.82		
0.00		
V 21	00.23.36	
	T19 81	

CUIDADO

PONTE ESTREITA







0.21		
V 15	00.24.12	
	T20 82	



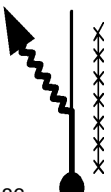

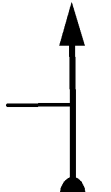
0.67		
V 15		
	T20 83	

cuidado

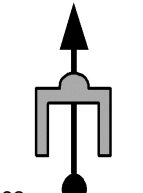
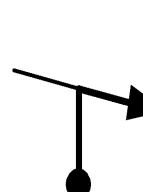
0.73		
V 15		
	T20 84	

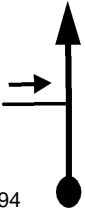
0.81		
V 15		
	T20 85	

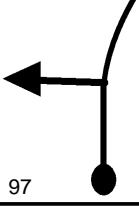
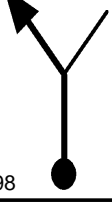
0.84	
V 33 00.26.43	
T21	86
1.04	
V 33	
T21	87
1.22	
N 3' 00.27.25	
T22	88
1.22	
V 30 00.30.25	
T23	89
1.42	
V 30	
T23	90
1.47	
V 30	
T23	91
1.58	
V 30	
T23	92
1.61	
0.00	
V 39 00.31.11	
T24	93

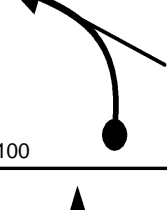
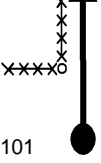
0.97	
V 39	
	T24 94
2.18	
V 39	
	T24 95
3.15	
V 39	
	T24 96
3.91	
V 39	
	T24 97
3.93	
V 30	00.37.14
	T25 98
4.12	
V 30	
	T25 99
4.27	
V 36	00.37.55
	T26 100
4.48	
V 36	
	T26 101

4.77		
V 36		
	T26 102	

entre no mato

4.95		
V 30	00.39.03	
	T27 103	

5.16		
V 30		
	T27 104	

5.22		
N1'30s	00.39.35	
	T28 105	

5.22		
V 27	00.41.05	
	T29 106	

5.28		
V 27		
	T29 107	

5.35		
V 27		
	T29 108	

5.38		
V 21	00.41.27	
	T30 109	

5.48	
V 21	
	T30 110
cuidado degrau pedra	
PERIGO	
5.58	
V 21	
	T30 111
5.92	
V 21	
	T30 112
6.18	
V 21	
	T30 113
6.26	
V 30	00.43.58
	T31 114
6.40	
N2'30s	00.44.14
	T32 115
6.40	
V 33	00.46.44
	T33 116
6.68	
V 33	
	T33 117

6.71		
V 21	00.47.18	
T34 118		

6.87		
V 27	00.47.46	
T35 119		



7.60		
V 39	00.49.23	
T36 120		







7.96		
V 39		
T36 121		

8.74		
V 30	00.51.08	
T37 122		

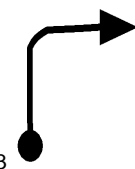



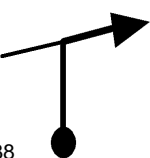

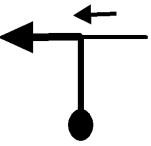
8.77		
V 30		
T37 123		

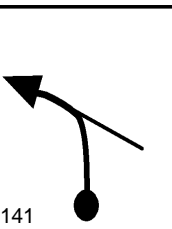
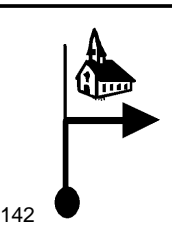
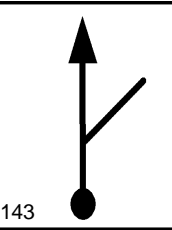
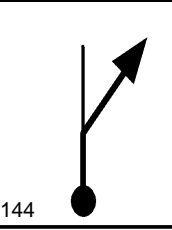
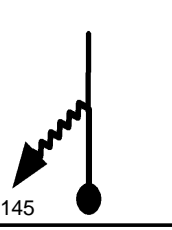
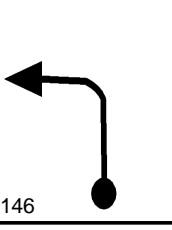
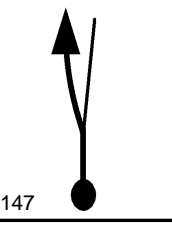
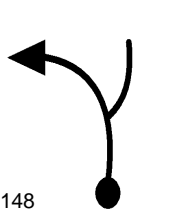
8.80		
V 30		
T37 124		

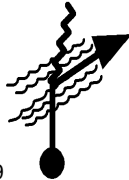
8.96	
V 33 00.51.34	
T38	125
9.01	
V 33	
T38	126
9.04	
V 33	
T38	127
9.40	
V 30 00.52.22	
T39	128
9.48	
V 30	
T39	129
9.74	
V 30	
T39	130
9.76	
V 33 00.53.06	
T40	131
9.90	
V 33	
T40	132

10.05	
V 33	
T40	133
10.09	
V 33	
T40	134
10.22	
V 33	
T40	135
10.27	
V 33	
T40	136
10.49	
V 33	
T40	137
10.51	
N1'30s 00.54.28	
T41	138
10.51	
V 39 00.55.58	
T42	139
10.78	
0.00	
V 39 00.56.22	
T43	140

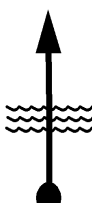
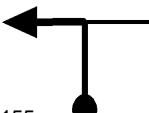
1.22	
V 39	
	T43 141
2.17	
V 39	
	T43 142
2.65	
V 39	
	T43 143
2.90	
V 39	
	T43 144
3.47	
V 33	01.01.43
	T44 145
3.94	
V 15	01.02.34
	T45 146
4.51	
V 15	
	T45 147
4.53	
V 15	
	T45 148

pelo rio	
4.61	
V 15	T45 149
4.64	
V 15	T45 150
saia do rio	
4.66	
V 24 01.05.27	T46 151
4.96	
V 24	T46 152
5.05	
V 24	T46 153
5.09	
V 24	T46 154
5.45	
N2'30s 01.07.25	T47 155
5.45	
V 39 01.09.55	T48 156

5.96		
V 39		
T48 157		

7.08		
V 39		
T48 158		

7.44		
V 39		
T48 159		

7.88		
V 39		
T48 160		

8.76		
V 39		
T48 161		







apoyo

zerar no poste

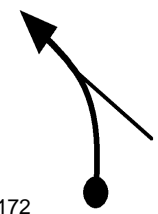
9.13		
0.00		
N 15'	01.15.35	
T49 162		

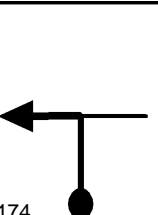
0.00		
V 39	01.30.35	
T50 163		

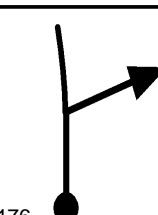
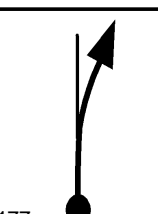
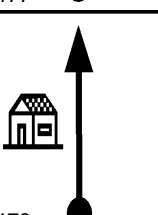
0.03	
V 39	
T50	164
0.88	
V 39	
T50	165
1.58	
V 30	01.33.01
T51	166
2.17	
V 18	01.34.12
T52	167
2.28	
V 37	01.34.34
T53	168
2.49	
V 37	
T53	169
2.86	
V 37	
T53	170
RIO COM PEDRAS	
3.08	
V 18	01.35.51
T54	171

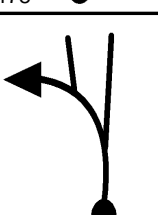
3.29	
V 24 01.36.33	
T55	172
3.41	
V 24	
T55	173
3.46	
N 2' 01.36.59	
T56	174
3.46	
V 39 01.38.59	
T57	175
3.87	
V 39	
T57	176
4.17	
V 18 01.40.04	
T58	177
4.26	
V 18	
T58	178
4.33	
V 27 01.40.36	
T59	179



4.45	
V 27	
T59	180

4.46	
V 24	01.40.54
T60	181

4.52	
V 24	
T60	182

4.91	
V 15	01.42.01
T61	183

5.19	
V 18	01.43.09
T62	184

5.45	
V 18	
T62	185

5.49	
V 18	
T62	186

5.57	
N2'30s 01.44.25	
T63	187

5.57	
V 30 01.46.55	
T64	188

5.84	
V 30	
T64	189

5.98	
V 42 01.47.44	
T65	190

6.71	
V 36 01.48.46	
T66	191



6.79	
V 36	
T66	192







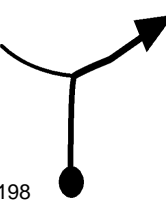
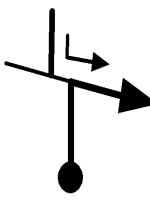
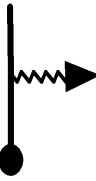
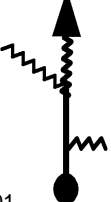
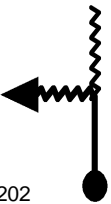

7.04	
V 36	
T66	193

SUBIDA COM MUITA EROSÃO





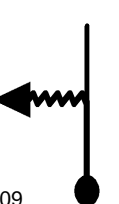



MUITO CUIDADO



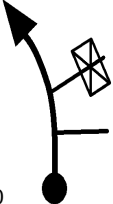
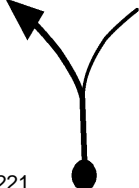
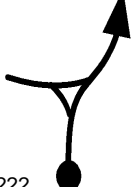



7.20	
V 18 01.49.35	
T67	194

7.50	
V 18	
T67	195
7.99	
N2'30s 01.52.13	
T68	196
7.99	
V 30 01.54.43	
T69	197
8.28	
V 39 01.55.18	
T70	198
9.27	
0.00	
V 39 01.56.49	
T71	199
0.13	
V 27 01.57.01	
T72	200
0.22	
V 15 01.57.13	
T73	201
0.38	
V 27 01.57.52	
T74	202

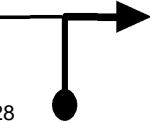
0.64	
V 33 01.58.27	
T75	203
0.88	
V 33	
T75	204
1.05	
V 33	
T75	205
1.33	
V 27 01.59.42	
T76	206
1.73	
V 33 02.00.35	
T77	207
2.02	
V 33	
T77	208
2.19	
V 15 02.01.25	
T78	209
2.31	
V 33 02.01.54	
T79	210

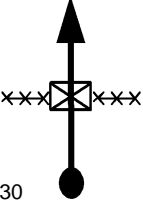
2.40	
V 33	
	T79 211
2.75	
V 33	
	T79 212
2.88	
N 2' 02.02.56	
	T80 213
2.88	
V 27 02.04.56	
	T81 214
2.94	
V 27	
	T81 215
3.27	
V 39 02.05.48	
	T82 216
3.77	
V 39	
	T82 217
3.89	
0.00	
V 39 02.06.46	
	T83 218

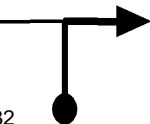
0.11		
V 39		
	T83	219
0.77		
V 39		
	T83	220
0.97		
V 39	02.08.15	
	T84	221
1.43		
V 39		
	T84	222
1.48		
V 39		
	T84	223
1.84		
V 39		
	T84	224
1.99		
V 36	02.09.49	
	T85	225
2.08		
V 36		
	T85	226

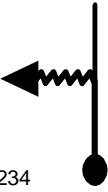
2.44	
V 36	
	T85 227
2.74	
V 36	
	T85 228
2.89	
V 30	02.11.19
	T86 229
3.05	
V 30	
	T86 230
3.28	
V 30	
	T86 231
3.29	
N2'30s	02.12.07
	T87 232
3.29	
V 39	02.14.37
	T88 233
3.81	
V 33	02.15.25
	T89 234

4.45		
V 33		
T89 235		

4.60		
V 33		
T89 236		

4.74		
V 33		
T89 237		

CUIDADO PEDRA

4.76		
V 27	02.17.09	
T90 238		





CUIDADO TOCO



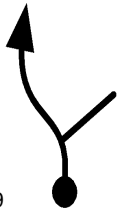

4.77		
V 33	02.17.10	
T91 239		



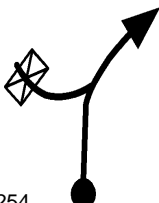
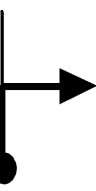
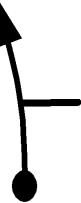

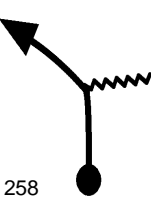
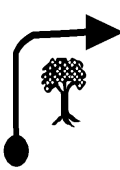



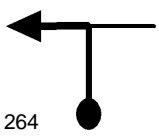

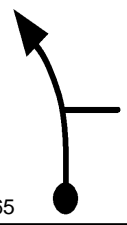
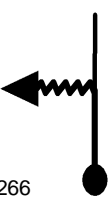
4.91		
V 33		
T91 240		

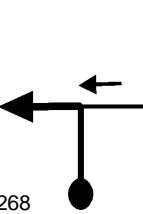
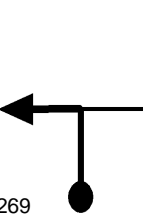
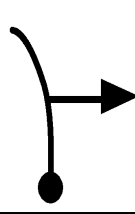

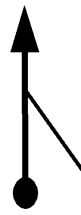
4.96	
V 33	
T91	241
5.06	
V 33	
T91	242
5.22	
V 33	
T91	243
5.30	
V 33	
T91	244
5.90	
V 33	
T91	245
5.96	
0.00	
V 33	02.19.20
T92	246
0.15	
V 33	
T92	247
0.32	
V 33	
T92	248

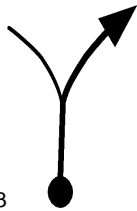
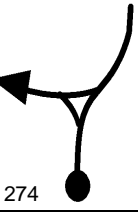
0.46	
V 33	
	T92 249
CUIDADO PEDRA	
0.49	
V 27	02.20.13
	T93 250
CUIDADO TOCO	
0.50	
V 33	02.20.15
	T94 251
0.63	
V 33	
	T94 252
0.68	
V 33	
	T94 253
0.78	
V 33	
	T94 254
0.95	
V 33	
	T94 255
1.02	
V 33	
	T94 256

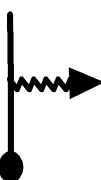
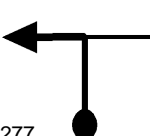
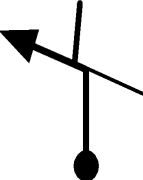
1.62	
V 33	
T94	257
1.68	
V 33	
T94	258
1.74	
V 33	
T94	259
1.84	
N2'30s 02.22.41	
T95	260
1.84	
V 39 02.25.11	
T96	261
2.11	
V 39	
T96	262
2.17	
V 39	
T96	263
2.41	
V 39	
T96	264

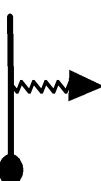
2.47	
V 39	
	T96 265
2.70	
V 33	02.26.30
	T97 266
2.75	
V 33	
	T97 267
3.01	
V 39	02.27.04
	T98 268
3.25	
V 39	
	T98 269
3.30	
N1'30s	02.27.31
	T99 270
3.30	
V 39	02.29.01
	T100 271
3.87	
V 39	
	T100 272

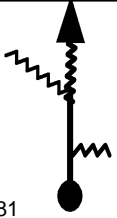
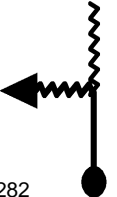
4.02	
V 39 02.30.07	
T101	273
4.47	
V 33 02.30.49	
T102	274
4.50	
V 33	
T102	275
4.72	
V 30 02.31.16	
T103	276
5.28	
V 36 02.32.23	
T104	277
6.10	
0.00	
N 2' 02.33.45	
T105	278
0.00	
V 39 02.35.45	
T106	279
0.13	
V 27 02.35.57	
T107	280

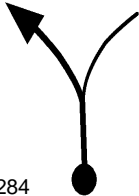
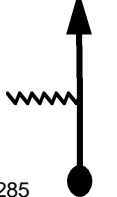
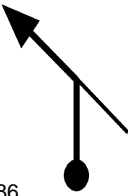
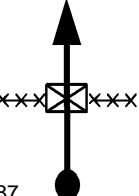
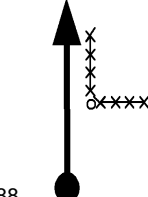
0.23	
V 15 02.36.11	
T108	281
0.39	
V 27 02.36.49	
T109	282
0.65	
0.00	
V 33 02.37.24	
T110	283
0.23	
V 33	
T110	284
0.40	
V 33	
T110	285
0.69	
V 33	
T110	286
1.20	
V 33	
T110	287
1.52	
N 2' 02.40.10	
T111	288

1.52	
V 30 02.42.10	
T112	289

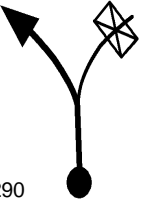
2.01	
V 30	
T112	290

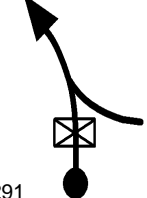
2.09	
V 39 02.43.18	
T113	291

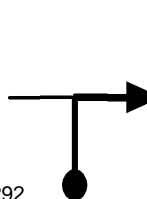
2.17	
V 39	
T113	292

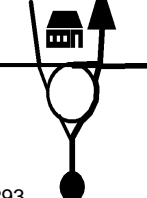
2.72	
V 39	
T113	293

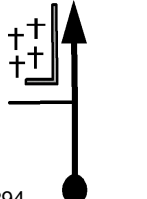
3.07	
V 33 02.44.48	
T114	294

CUIDADO DESCIDA COM EROSÕES

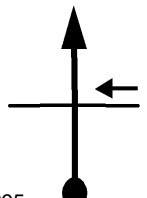
3.46	
V 30 02.45.31	
T115	295

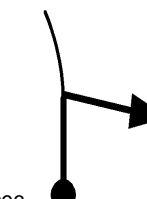
3.52	
V 30	
T115	296

3.60		
V 30		
T115 297		

3.76		
V 30		
T115 298		

3.82		
V 33	02.46.14	
T116 299		





3.96		
V 33		
T116 300		

4.01		
V 33		
T116 301		

4.07		
V 33		
T116 302		

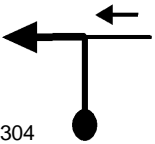
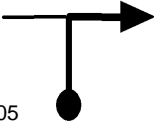
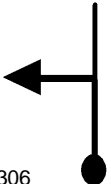
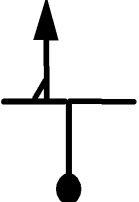
4.14		
V 33		
T116 303		

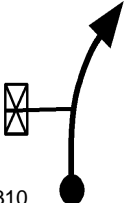
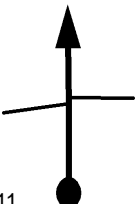
4.32	
V 33	
	T116 304
4.38	
V 33	
	T116 305
4.45	
V 33	
	T116 306
4.58	
0.00	
N 2' 02.47.37	
	T117 307
0.00	
V 42 02.49.37	
	T118 308
0.44	
V 42	
	T118 309
1.29	
V 42	
	T118 310
2.84	
V 42	
	T118 311

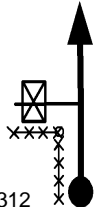
3.78	
V 42	
T118	312

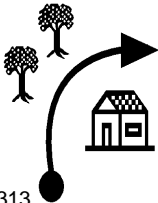
4.88	
V 42	
T118	313

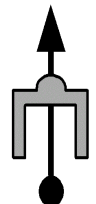
5.85	
V 42	02:57:58
T118	314

FIM DE PROVA !!



www.t15.com.br

Tempo de Prova

MÉDIA B 02:57:58

FIM