

INICIO

MÉDIA A

2ª ENDURO DO TAQUARI
22/07/2017



IMPORTANTE

☠	CUIDADO
☠☠	ATENÇÃO
☠☠☠	MUITA ATENÇÃO

Tempo de Prova

MÉDIA A 02:55:42



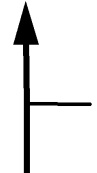

AFERIÇÃO

0.00	
AFER	1
0.10	
AFER	2
0.89	
AFER	3

1.05	
AFER	4

1.37	
AFER	5

1.48	
AFER	6



NO POSTE	
1.76	
AFER	7

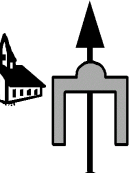

INICIO DE PROVA

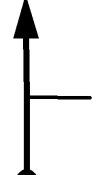
0.00	
V 39	00.00.00
T1	8

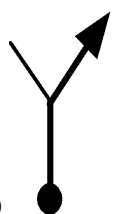
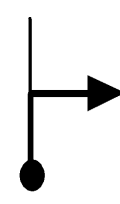
0.10	
V 39	
T1	9

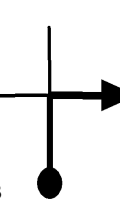
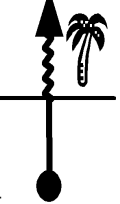
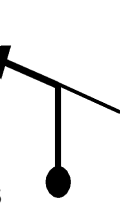
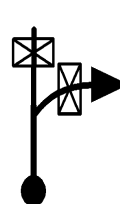
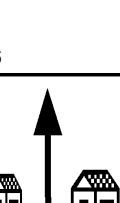
0.89		
V 39	T1 10	
1.05		
V 39	00.01.37 T2 11	
1.39		
V 39	T2 12	
1.59		
V 33	00.02.27 T3 13	
1.86		
V 33	T3 14	
1.87		
V 27	00.02.57 T4 15	
1.98		
0.00		
V 27	00.03.12 T5 16	
0.06		
V 27	T5 17	

entre no mato

siga bamp

0.12



V 24 | 00.03.28

T6

18

0.25



V 33 | 00.03.47

T7

19

0.64

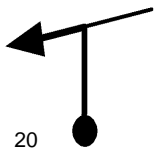

V 33

T7

20

0.67

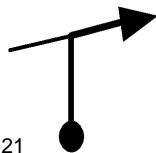

V 33

T7

21

baixe a cabeça

0.77



V 33

T7

22

1.04

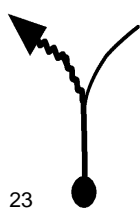

V 33

T7

23



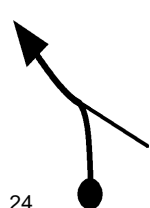

1.16

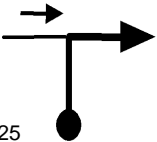

V 33

T7

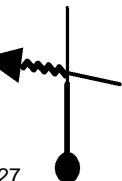
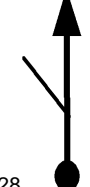
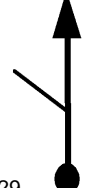
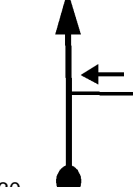
24

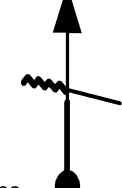
1.23	
V 36	00.05.34
T8	25
1.29	
V 36	
T8	26
1.34	
V 36	
T8	27
1.36	
V 36	
T8	28
1.59	
V 36	
T8	29
1.64	
V 36	
T8	30
1.71	
V 36	
T8	31
1.76	
V 36	
T8	32

2.00		
V 36		
	T8 33	

2.11		
V 36		
	T8 34	

cuidado

2.24		
N 3'	00.07.15	
	T9 35	

2.24		
V 36	00.10.15	
	T10 36	

2.28		
V 36		
	T10 37	







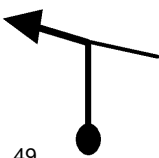

2.33		
V 36		
	T10 38	

sigla bamp

2.43		
V 36		
	T10 39	

2.44		
V 36		
	T10 40	

2.52	
V 36	
	T10 41
2.53	
V 36	
	T10 42
2.59	
V 36	
	T10 43
2.69	
V 36	
	T10 44
2.84	
V 27	00.11.15
	T11 45
3.07	
V 36	00.11.46
	T12 46
3.16	
V 36	
	T12 47
3.32	
V 36	
	T12 48

3.45	
V 36	
T12	49
3.55	
V 36	
T12	50
3.81	
V 36	
T12	51
4.28	
V 36	
T12	52
4.43	
V 36	
T12	53
4.55	
V 36	
T12	54
4.72	
V 36	
T12	55
4.80	
V 36	
T12	56

4.86		
V 36		
	T12 57	

4.94		
V 36		
	T12 58	

5.22		
V 36		
	T12 59	



5.28		
V 36		
	T12 60	

5.42		
V 36		
	T12 61	

5.54		
V 36		
	T12 62	

5.61		
V 36		
	T12 63	

entre no mato

5.70

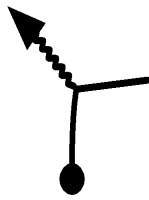

0.00

N 3' 00.16.09

T13

64

0.00



V 30 00.19.09

T14

65

0.16



V 30

T14

66

0.28

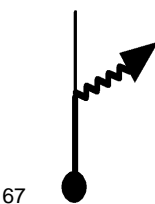

V 18 00.19.43

T15

67

0.32

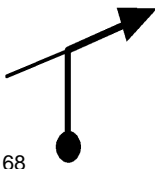

V 18

T15

68

0.38

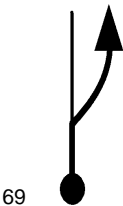

V 18

T15

69



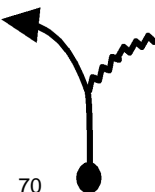

0.50

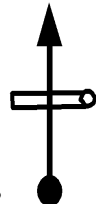
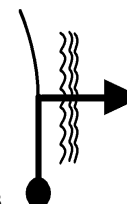
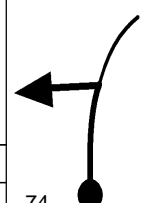

V 30 00.20.27

T16

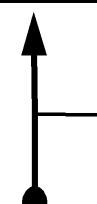
70

0.58		
V 30		
	T16	71
BAIXE A CABEÇA		
0.72		
V 30		
	T16	72
0.87		
V 30		
	T16	73
0.92		
V 30		
	T16	74
1.07		
V 30		
	T16	75
1.13		
V 33	00.21.42	
	T17	76
1.29		
V 33		
	T17	77
1.37		
V 33		
	T17	78

1.53		
V 33		
	T17 79	

ENTRE NO MATO

1.59		
V 30	00.22.32	
	T18 80	

1.82		
0.00		
V 24	00.23.00	
	T19 81	

CUIDADO

PONTE ESTREITA







0.21		
V 18	00.23.32	
	T20 82	



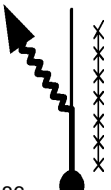

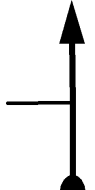

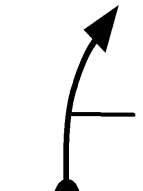
0.67		
V 18		
	T20 83	

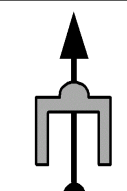
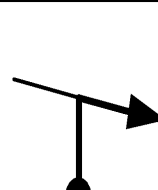
cuidado

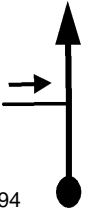
0.73		
V 18		
	T20 84	

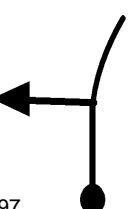
0.81		
V 18		
	T20 85	

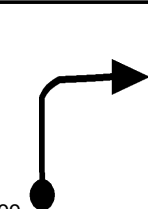
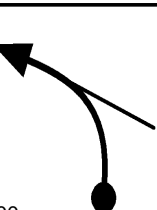
0.84	
V 36 00.25.38	
T21	86
1.04	
V 36	
T21	87
1.22	
N 3' 00.26.16	
T22	88
1.22	
V 33 00.29.16	
T23	89
1.42	
V 33	
T23	90
1.47	
V 33	
T23	91
1.58	
V 33	
T23	92
1.61	
0.00	
V 39 00.29.58	
T24	93

0.97	
V 39	
T24	94
2.18	
V 39	
T24	95
3.15	
V 39	
T24	96
3.91	
V 39	
T24	97
3.93	
V 33	00.36.01
T25	98
4.12	
V 33	
T25	99
4.27	
V 39	00.36.38
T26	100
4.48	
V 39	
T26	101

4.77	
V 39	
	T26 102
entre no mato	
4.95	
V 33	00.37.41
	T27 103
5.16	
V 33	
	T27 104
5.22	
N1'30s	00.38.10
	T28 105
5.22	
V 27	00.39.40
	T29 106
5.28	
V 27	
	T29 107
5.35	
V 27	
	T29 108
5.38	
V 24	00.40.01
	T30 109

5.48	
V 24	
	T30 110
cuidado degrau pedra	
PERIGO	
5.58	
V 24	
	T30 111
5.92	
V 24	
	T30 112
6.18	
V 24	
	T30 113
6.26	
V 33	00.42.13
	T31 114
6.40	
N 3'	00.42.29
	T32 115
6.40	
V 36	00.45.29
	T33 116
6.68	
V 36	
	T33 117

6.71		
V 24	00.46.00	
T34		118

6.87		
V 30	00.46.24	
T35		119



7.60		
V 39	00.47.51	
T36		120







7.96		
V 39		
T36		121

8.74		
V 33	00.49.37	
T37		122

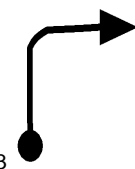
8.77		
V 33		
T37		123

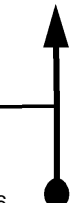
8.80		
V 33		
T37		124

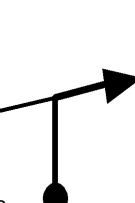
8.96	
V 36 00.50.01	
T38	125
9.01	
V 36	
T38	126
9.04	
V 36	
T38	127
9.40	
V 33 00.50.45	
T39	128
9.48	
V 33	
T39	129
9.74	
V 33	
T39	130
9.76	
V 36 00.51.24	
T40	131
9.90	
V 36	
T40	132

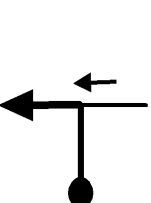
10.05	
V 36	
T40	133
10.09	
V 36	
T40	134
10.22	
V 36	
T40	135
10.27	
V 36	
T40	136
10.49	
V 36	
T40	137
10.51	
N 2' 00.52.39	
T41	138
10.51	
V 39 00.54.39	
T42	139
10.78	
0.00	
V 39 00.55.04	
T43	140

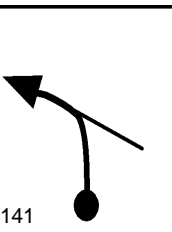
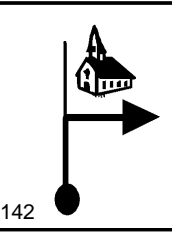
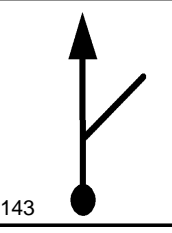
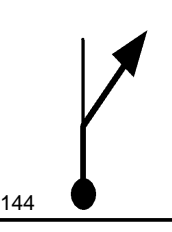
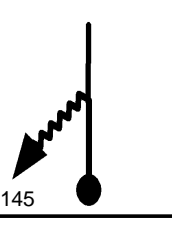
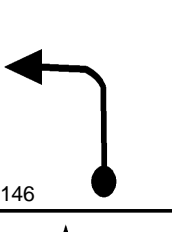
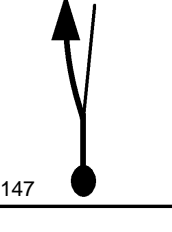
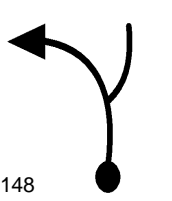
1.22	
V 39	
T43	141
2.17	
V 39	
T43	142
2.65	
V 39	
T43	143
2.90	
V 39	
T43	144
3.47	
V 36	01.00.24
T44	145
3.94	
V 18	01.01.11
T45	146
4.51	
V 18	
T45	147
4.53	
V 18	
T45	148

pelo rio	
4.61	
V 18	T45 149
4.64	
V 18	T45 150
saia do rio	
4.66	
V 27 01.03.35	T46 151
4.96	
V 27	T46 152
5.05	
V 27	T46 153
5.09	
V 27	T46 154
5.45	
N 3' 01.05.20	T47 155
5.45	
V 39 01.08.20	T48 156

5.96		
V 39		
	T48 157	

7.08		
V 39		
	T48 158	

7.44		
V 39		
	T48 159	

7.88		
V 39		
	T48 160	



8.76		
V 39		
	T48 161	





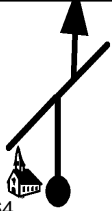
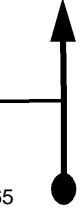
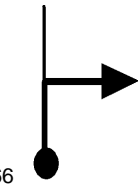
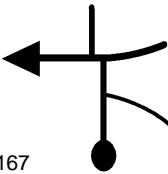
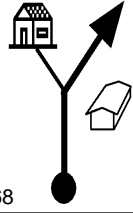
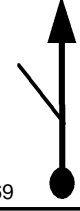

apoio

zerar no poste

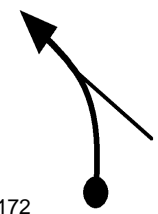
9.13		
0.00		
N 15'	01.14.00	
	T49 162	

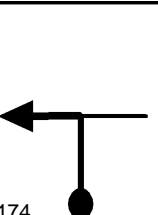
0.00		
V 39	01.29.00	
	T50 163	

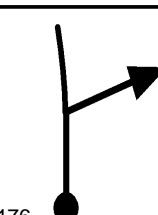
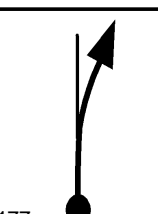
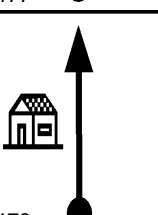
0.03	
V 39	
T50	164
0.88	
V 39	
T50	165
1.58	
V 33	01.31.26
T51	166
2.17	
V 21	01.32.30
T52	167
2.28	
V 39	01.32.49
T53	168
2.49	
V 39	
T53	169
2.86	
V 39	
T53	170
RIO COM PEDRAS	
3.08	
V 21	01.34.03
T54	171

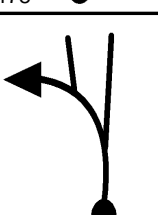
3.29	
V 24 01.34.39	
T55	172
3.41	
V 24	
T55	173
3.46	
N2'30s 01.35.04	
T56	174
3.46	
V 39 01.37.34	
T57	175
3.87	
V 39	
T57	176
4.17	
V 18 01.38.40	
T58	177
4.26	
V 18	
T58	178
4.33	
V 30 01.39.12	
T59	179



4.45	
V 30	
	T59 180

4.46	
V 27	01.39.28
	T60 181



4.52	
V 27	
	T60 182

4.91	
V 18	01.40.28
	T61 183

5.19	
V 21	01.41.24
	T62 184

5.45	
V 21	
	T62 185

5.49	
V 21	
	T62 186

5.57	
N2'30s 01.42.29	
T63	187

5.57	
V 30 01.44.59	
T64	188

5.84	
V 30	
T64	189

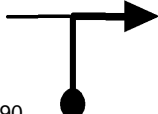
5.98	
V 42 01.45.48	
T65	190

6.71	
V 39 01.46.50	
T66	191



6.79	
V 39	
T66	192





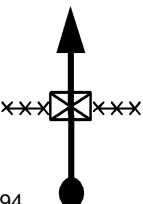

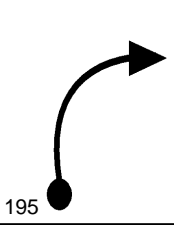
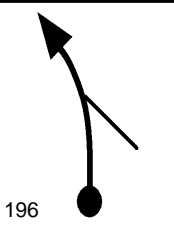

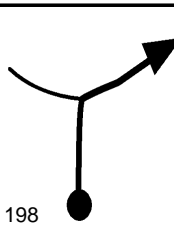
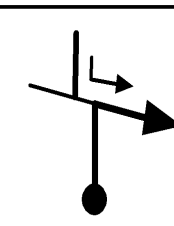
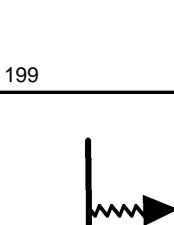
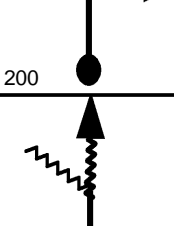
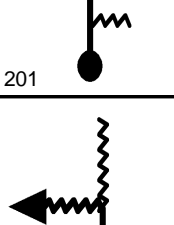
7.04	
V 39	
T66	193





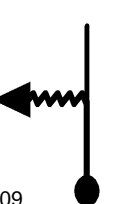

SUBIDA COM MUITA EROSÃO



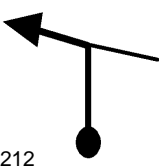



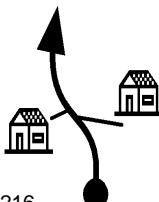

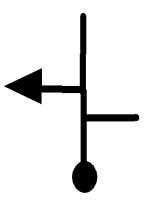

MUITO CUIDADO



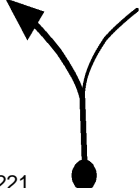
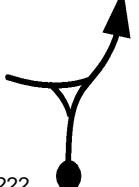



7.20	
V 21 01.47.36	
T67	194

7.50	
V 21	
	T67 195
7.99	
N2'30s 01.49.51	
	T68 196
7.99	
V 30 01.52.21	
	T69 197
8.28	
V 39 01.52.56	
	T70 198
9.27	
0.00	
V 39 01.54.27	
	T71 199
0.13	
V 30 01.54.39	
	T72 200
0.22	
V 18 01.54.50	
	T73 201
0.38	
V 30 01.55.22	
	T74 202

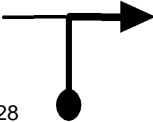
0.64	
V 36 01.55.53	
T75	203
0.88	
V 36	
T75	204
1.05	
V 36	
T75	205
1.33	
V 30 01.57.02	
T76	206
1.73	
V 36 01.57.50	
T77	207
2.02	
V 36	
T77	208
2.19	
V 18 01.58.36	
T78	209
2.31	
V 36 01.59.00	
T79	210

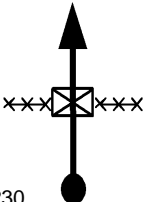
2.40	
V 36	
	T79 211
2.75	
V 36	
	T79 212
2.88	
N2'30s 01.59.57	
	T80 213
2.88	
V 27 02.02.27	
	T81 214
2.94	
V 27	
	T81 215
3.27	
V 39 02.03.19	
	T82 216
3.77	
V 39	
	T82 217
3.89	
0.00	
V 39 02.04.17	
	T83 218

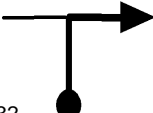
0.11		
V 39		
	T83	219
0.77		
V 39		
	T83	220
0.97		
V 42	02.05.46	
	T84	221
1.43		
V 42		
	T84	222
1.48		
V 42		
	T84	223
1.84		
V 42		
	T84	224
1.99		
V 39	02.07.13	
	T85	225
2.08		
V 39		
	T85	226

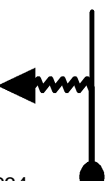
2.44	
V 39	
	T85 227
2.74	
V 39	
	T85 228
2.89	
V 33	02.08.37
	T86 229
3.05	
V 33	
	T86 230
3.28	
V 33	
	T86 231
3.29	
N 3'	02.09.20
	T87 232
3.29	
V 39	02.12.20
	T88 233
3.81	
V 36	02.13.08
	T89 234

4.45		
V 36		
T89 235		

4.60		
V 36		
T89 236		

4.74		
V 36		
T89 237		

CUIDADO PEDRA

4.76		
V 30	02.14.43	
T90 238		

CUIDADO TOCO

4.77		
V 36	02.14.44	
T91 239		



4.91		
V 36		
T91 240		

4.96		
V 36		
T91 241		

5.06		
V 36		
T91 242		

5.22		
V 36		
T91 243		





5.30		
V 36		
T91 244		



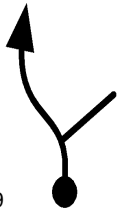

5.90		
V 36		
T91 245		



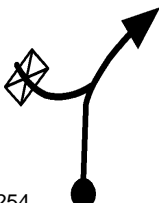
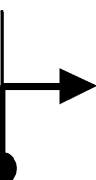
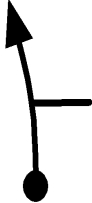

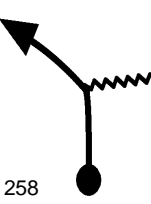
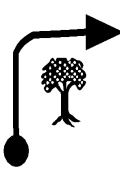
5.96		
0.00		
V 36	02.16.43	
T92 246		

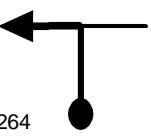

0.15		
V 36		
T92 247		

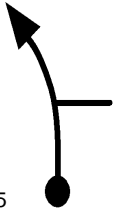
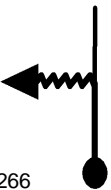
0.32		
V 36		
T92 248		

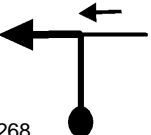
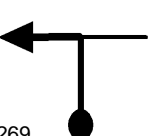
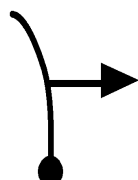
0.46	
V 36	
	T92 249
CUIDADO PEDRA	
0.49	
V 30	02.17.32
	T93 250
CUIDADO TOCO	
0.50	
V 36	02.17.34
	T94 251
0.63	
V 36	
	T94 252
0.68	
V 36	
	T94 253
0.78	
V 36	
	T94 254
0.95	
V 36	
	T94 255
1.02	
V 36	
	T94 256

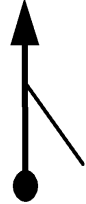
1.62	
V 36	
T94	257
1.68	
V 36	
T94	258
1.74	
V 36	
T94	259
1.84	
N 3' 02.19.48	
T95	260
1.84	
V 39 02.22.48	
T96	261
2.11	
V 39	
T96	262
2.17	
V 39	
T96	263
2.41	
V 39	
T96	264

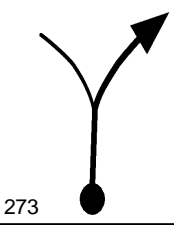
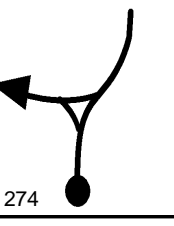
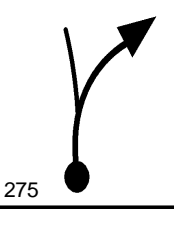
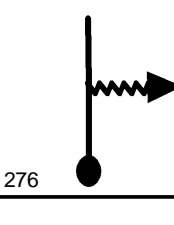
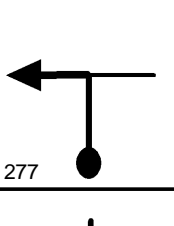
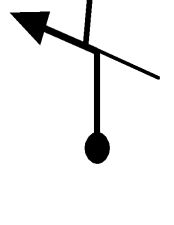
2.47	
V 39	
	T96 265
2.70	
V 36	02.24.07
	T97 266
2.75	
V 36	
	T97 267
3.01	
V 39	02.24.38
	T98 268
3.25	
V 39	
	T98 269
3.30	
N 2'	02.25.05
	T99 270
3.30	
V 39	02.27.05
	T100 271
3.87	
V 39	
	T100 272

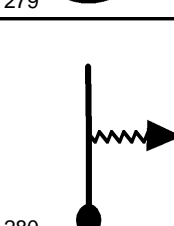
4.02	
V 42 02.28.11	
T101	273
4.47	
V 36 02.28.50	
T102	274
4.50	
V 36	
T102	275
4.72	
V 33 02.29.15	
T103	276
5.28	
V 39 02.30.16	
T104	277
6.10	
0.00	
N2'30s 02.31.32	
T105	278
0.00	
V 39 02.34.02	
T106	279
0.13	
V 30 02.34.14	
T107	280

0.23		
V 15	02.34.26	
T108 281		

0.39		
V 30	02.35.04	
T109 282		

0.65		
0.00		
V 36	02.35.35	
T110 283		

0.23		
V 36		
T110 284		

0.40		
V 36		
T110 285		

0.69		
V 36		
T110 286		

1.20		
V 36		
T110 287		

1.52		
N 2'	02.38.07	
T111 288		

1.52	
V 30 02.40.07	
T112 289	

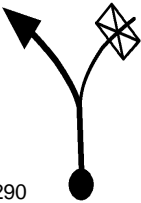
2.01	
V 30	
T112 290	

2.09	
V 39 02.41.16	
T113 291	

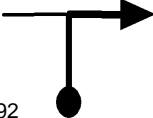
2.17	
V 39	
T113 292	

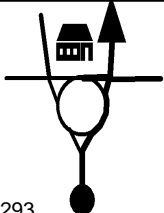
2.72	
V 39	
T113 293	

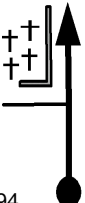
3.07	
V 36 02.42.46	
T114 294	

CUIDADO DESCIDA COM EROSÕES

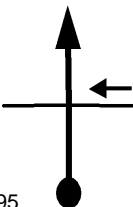
3.46	
V 33 02.43.25	
T115 295	

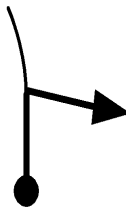
3.52	
V 33	
T115 296	

3.60		
V 33		
T115 297		

3.76		
V 33		
T115 298		

3.82		
V 36	02.44.04	
T116 299		





3.96		
V 36		
T116 300		

4.01		
V 36		
T116 301		

4.07		
V 36		
T116 302		

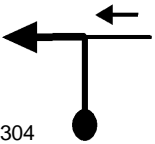
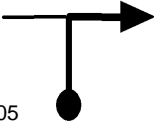
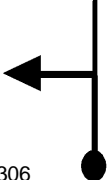
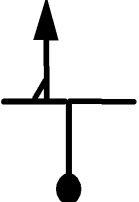
4.14		
V 36		
T116 303		

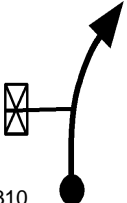
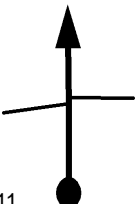
4.32	
V 36	
	T116 304
4.38	
V 36	
	T116 305
4.45	
V 36	
	T116 306
4.58	
0.00	
N 2' 02.45.20	
	T117 307
0.00	
V 42 02.47.20	
	T118 308
0.44	
V 42	
	T118 309
1.29	
V 42	
	T118 310
2.84	
V 42	
	T118 311

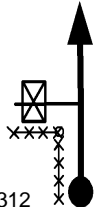
3.78	
V 42	
	T118 312

4.88	
V 42	
	T118 313

5.85	
V 42	02.55.42
	T118 314

FIM DE PROVA !!



www.t15.com.br

Tempo de Prova

MÉDIA A 02:55:42

FIM