

INICIO

45 - DUPLA - ESTRE

Vº ENDURO ENTRE A SERRA E O MAR
16 DE JULHO DE 2016



IMPORTANTE

**ENDURO ENTRE A SERRA
E O MAR 2016
GRAVATAL-SC
16 DE JULHO DE 2016**

**DIRETOR DE PROVA:
RICARDO DAUFEMBACK**

**SUPERVISOR:
JONAS SCHULZ**

**DISTANCIA:
65,83 KM**

**LARGADA:
COMUNIDADE DE SÃO
ROQUE**



**NEUTRO:
COMUNIDADE DE SÃO
ROQUE**

**CHEGADA:
COMUNIDADE DE SÃO
ROQUE**

**RESPEITE AS LEIS DE
TRANSITO E
PRINCIPALMENTE
OS TERRENOS E SEUS
RESPECTIVOS DONOS.**

**NA DUVIDA,
ACELERAAAAA...
...MAS DENTRO DE SEUS
LIMITES.**

BOM APETITE.

	CUIDADO
	ATENÇÃO
	MUITA ATENÇÃO



Tempo de Prova

45 - DUPLA - ESTRE 03:02:16

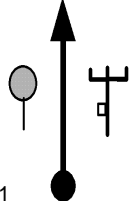

AFERIÇÃO NO POSTE BAMP

0.00	
AFER 1	

AFERIÇÃO	
0.29	
2	

AFERIÇÃO	
0.70	
3	

AFERIÇÃO

0.88



4

NO POSTE

BAMP

RETORNE

POR ONDE VEIO.

1.505

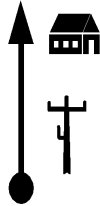

0.00

5



INICIO DE PROVA

INICIO DE PROVA

TRECHO COM

MOTO CONTRA

CUIDADO

0.00

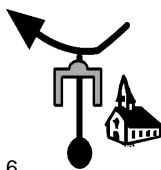

V 36 00.00.00

T1

6

0.28



7

PELA PRINCIPAL

0.69



8

1.27



9

1.51



10

2.17

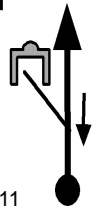

11

2.20



12

2.38



13

FIM

MOTO





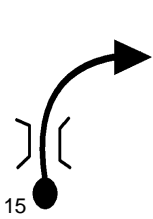
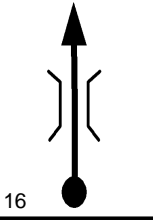
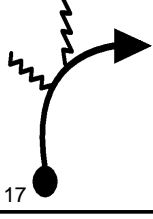
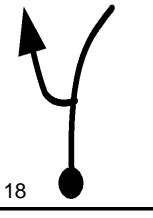
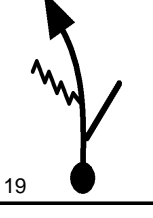
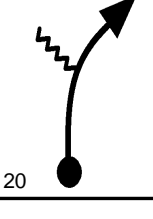
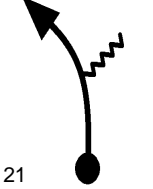

CONTRA

2.88

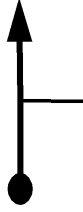

14

3.88	
4.29	
4.56	
E VAI COMECAR...	
LIMPANDO A VELA 1	
TRILHA DA ARGILA	
4.78	
V 35 00.07.58	
T2	18
4.89	
4.92	
5.16	

5.34	
V 37 00.08.56	22
T3	
5.92	
	23
6.12	
	24
7.02	
	25
7.04	
	26
7.09	
	27
7.17	
V 32 00.11.54	28
T4	

7.40	
	29
7.63	
0.00	
N 2' 00.12.45	
T5	30
0.00	
V 27 00.14.45	
T6	31
DESCIDA COM EROSÕES	
0.22	
	32
0.44	
V 28 00.15.44	
T7	33
DESVIO	
BARREIRA	
1.21	
	34

PEDRAS

1.56



1.73

V 31 | 00.18.30

T8



1.74

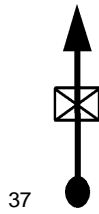

HARD 1

DESCENDO

1.87

V 27 | 00.18.46

T9



2.08

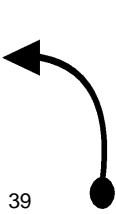

2.26



2.43

V 26 | 00.20.01

T10

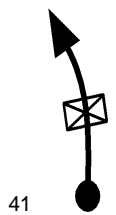

PELA ESQUERDA

2.74



42

ESCOLHA

3.37



43

V 20 00.22.11

T11

3.71

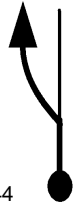

44

NAO ERRE

3.78

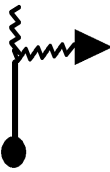

45

3.82

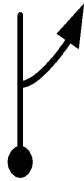

46

4.04







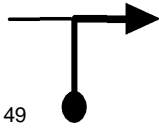

47

4.24



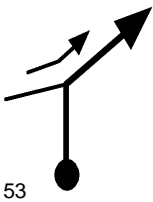
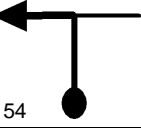
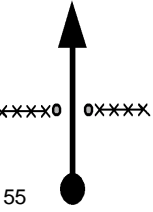

48

4.40		
V 27	00.25.16	
T12 49		
BAMP		
4.59		
50		
4.63		
N2'30s	00.25.47	
T13 51		
4.63		
V 20	00.28.17	
T14 52		
4.67		
53		
4.82		
V 31	00.28.51	
T15 54		
5.00		
V 38	00.29.12	
T16 55		

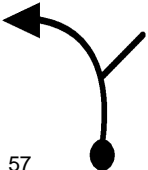
5.28	
	56

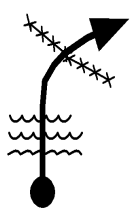
5.75	
	57

5.82	
0.00	
N 2' 00.30.30	
T17	58

0.00	
V 30 00.32.30	
T18	59





ESTILO INDEPENDENCIA

SUBINDO

SEGURAAAAAA

0.13	
V 31 00.32.45	
T19	60

1.94	
	61

2.10	
	62

PELA ESQUERDA

MATA-BURRO



3.65	
	63



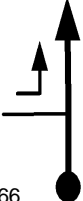

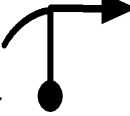
3.83	
0.00	
N3'30s 00.39.55	
T20	64

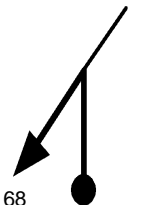
0.00	
V 31 00.43.25	
T21	65

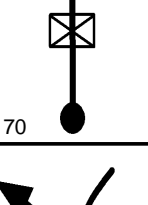
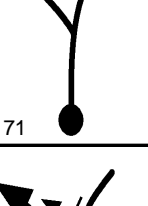
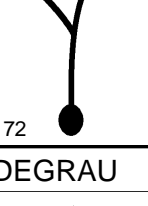
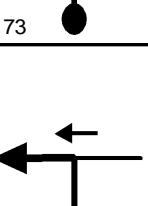
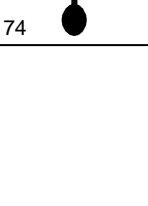

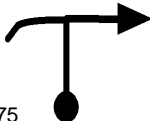
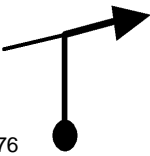

0.17	
	66





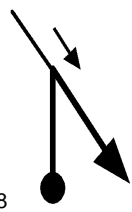
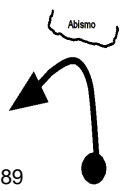

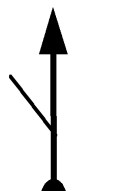
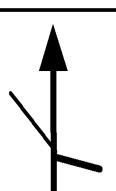
0.46	
	67

0.83	
	68
0.84	
V 31 00.45.03	69
	T22
1.11	
	70
1.25	
	71
1.28	
V 28 00.45.54	72
	T23
CUIDADO DEGRAU	
1.44	
	73
1.48	
	74

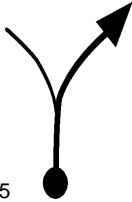
1.76	
	75
2.13	
	76
SITIO MEDICO	
2.22	
N2'30s 00.47.55	
T24	77
DEVAGAR	
INICIO RADAR	
2.22	
V 24 00.50.25	
T25	78
FIM RADAR	
2.45	
V 30 00.50.59	
T26	79
TRILHA DA HELENA	
2.76	
V 35 00.51.36	
T27	80

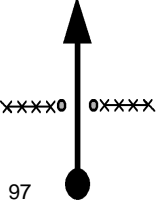
3.44	
	81
3.54	
V 38 00.52.56	82
T28	
3.80	
	83
CURVA PERIGOSA	
3.95	
	84
ATENÇÃO	
NAO ERRE	
4.08	
V 30 00.53.48	85
T29	
4.20	
V 36 00.54.02	86
T30	
4.23	
	87

4.43	
V 38 00.54.25	
T31	88
CURVA PERIGOSA	
4.59	
	89
4.71	
V 36 00.54.52	
T32	90
4.84	
	91
4.92	
	92
4.96	
	93
5.05	
	94

5.13		
V 27	00.55.34	
T33 95		
DESCE		
EROSOES		
5.74		
V 19	00.56.55	
T34 96		
5.89		
V 19 00.57.23		
T35 97		
5.94		
V 19 00.58.14		
T36 98		
6.10		
V 19 00.59.14		
T37 99		
BAMP		
6.15		
T38 100		
6.16		
V 27	00.58.14	
T36 101		

6.22	
	102
6.34	
	103
CURRAL	
6.51	
	104
6.57	
0.00	
N 2' 00.59.09	
T37	105
TRILHA DO DIRCEU	
0.00	
V 33 01.01.09	
T38	106
0.21	
	107
0.22	
	108

0.40		
	109	

0.44		
	110	

0.68		
V 30	01.02.23	
T39		
		111

CUIDADO

SOBE

0.80		
V 25	01.02.38	
T40		
		112

0.91		
	113	

1.05		
V 27	01.03.14	
T41		
		114

CUIDADO

DESCE

1.13		
	115	

1.36		
N 1'	01.03.55	
T42 116		

1.36		
V 36	01.04.55	
T43 117		

1.60		
V 36	01.05.19	
T44 118		

PEDRA







2.47		
	119	

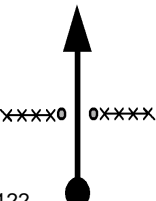
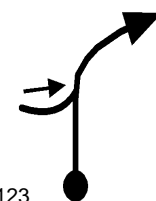
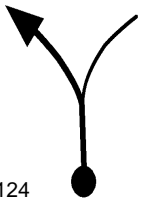
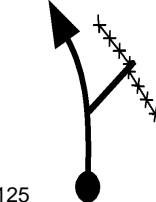
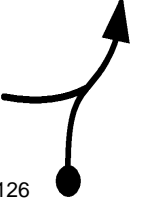
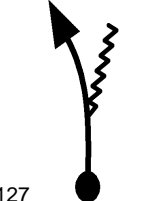
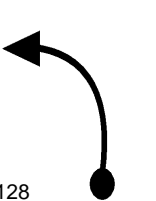









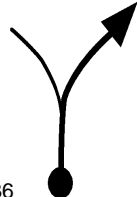
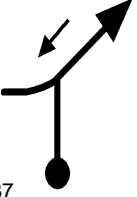

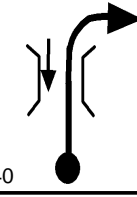
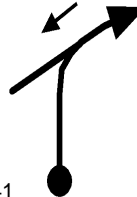
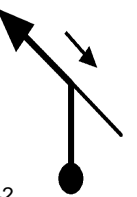
2.68		
	120	



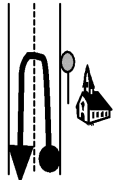



2.77		
	121	

3.05	
	122
3.17	
V 33 01.07.56	123
3.28	
	124
3.34	
	125
3.38	
	126
3.52	
	127
SOBE	
3.67	
	128

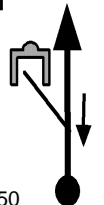
<p>3.93</p>	 <p>129</p>
<p>4.02</p>	 <p>130</p>
<p>4.05</p>	 <p>131</p>
<p>4.16</p>	 <p>132</p>
<p>4.27</p>	 <p>133</p>
<p>4.37</p>	 <p>134</p>
<p>4.40</p>	 <p>135</p>

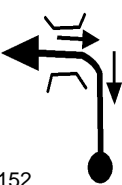
4.51	
	136
ESTRADA O	
INICIO MOTO CONTRA	
4.53	
	137
4.56	
Nº 30 s 01.10.28	T46
	138
4.56	
V 36 01.12.58	T47
	139
5.04	
	140
6.15	
	141
6.72	
	142

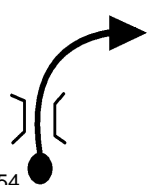
7.14	
	143
APOIO PRINCIPAL	
SÃO ROQUE	
7.41	
0.00	
N 18' 01.17.43	
	T48 144
0.00	
V 33 01.35.43	
	T49 145
0.28	
	146
0.69	
	147
1.27	
	148
1.51	
	149

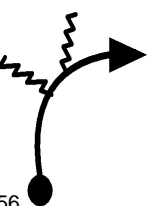
2.17	
	150
2.20	
	151
2.38	
	152
2.88	
V 36 01.40.57	153
3.88	
	154
4.29	
	155
4.56	
	156

LIMPANDO A VELA 2

4.78



V 38 | 01.44.07

T51 157

4.89



158

4.92



V 39 | 01.44.20

T52 159

5.16



160

5.34



161

5.92







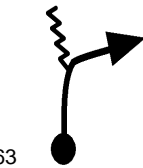

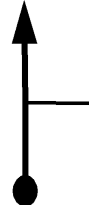

162

6.12



163

7.02	
	164
7.04	
	165
7.09	
	166
7.17	
V 30 01.47.48 T53	167
7.40	
	168
7.63	
0.00 N 2' 01.48.43 T54	169
0.00	
V 27 01.50.43 T55	170

0.22	
	171

TRILHA DO VELHO DA CACHAÇA

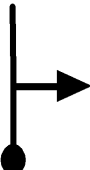

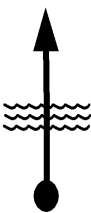
0.44	
	172

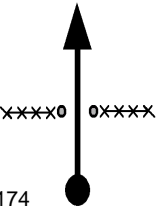
1.26	
	173

1.72	
V 28 01.54.32	
T56	174

DESCE PEDRAS

CUIDADOOOOOOO...

2.34	
	
	175

2.43	
	176

2.87	
	177

3.05	
	178

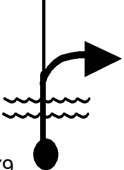
RIO FUNDO	
3.09	
N1'30s	01.57.28
T57	179







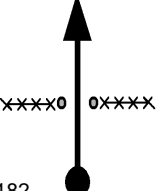

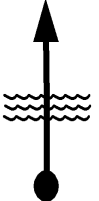

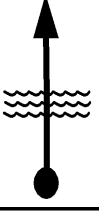

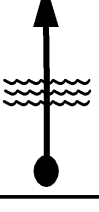
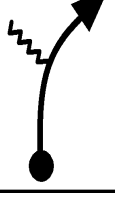

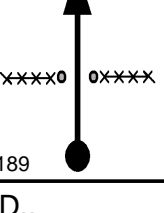
3.09	
V 34	01.58.58
T58	180

3.23	
	181

3.28	
	182

3.37	
	183

3.50	
V 27 01.59.42	
T59	184
3.80	
	185
3.92	
	186
4.01	
	187
4.19	
	188
4.41	
	189
HARD..	
4.54	
	190

4.96	
0.00	
N 2' 02.02.57	
T60 191	
TRILHA DA PEDREIRA	
0.00	
V 34 02.04.57	
T61 192	
CUIDADO	
0.64	
	193
1.41	
	194
1.52	
N 1' 02.07.37	
T62 195	
1.52	
V 30 02.08.37	
T63 196	
TRECHO A SEGUIR COM LAGE LISA MUITO CUIDADO....	
1.60	
	197

1.73		
	198	

LISOOOO...

LAGE DE PEDRA

1.91		
V 21	02.09.24	
T64 199		

SOBE

1.94		
	200	



2.28		
V 30	02.10.28	
T65 201		

2.42		
	202	



2.50		
	203	

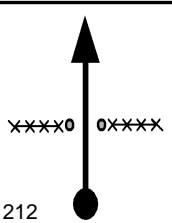
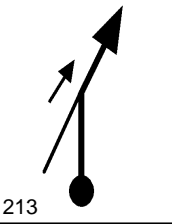
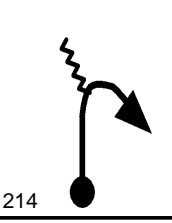
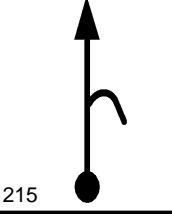
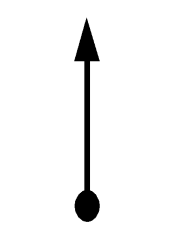

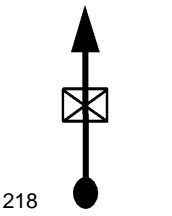

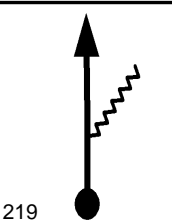
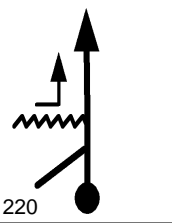
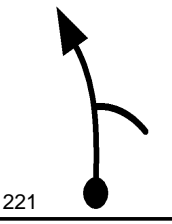
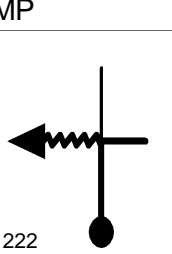
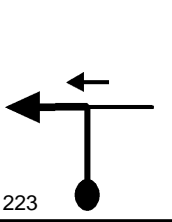
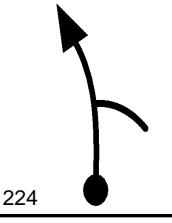
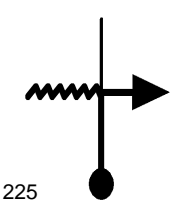
2.63		
V 34	02.11.10	
T66 204		

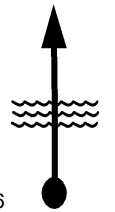
2.78	
	205
3.10	
	206
3.12	
	207
3.23	
V 33 02.12.13	T67 208
CUIDADO	
BEMMM LISOOOO..	
3.50	
	209
LAGE DE PEDRA	
3.60	
V 21 02.12.54	T68 210
LISO	
3.72	
	211

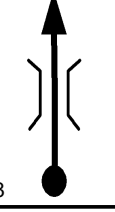
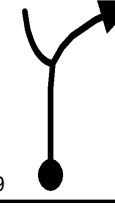
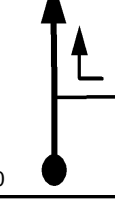
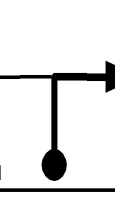
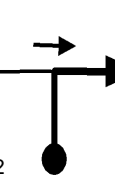
4.06	
V 33 02.14.12	
T69	212
4.21	
	213
4.27	
	214
4.42	
	215
CURTA O VISUAL	
4.47	
0.00	
N 3' 02.14.57	
T70	216
0.00	
V 36 02.17.57	
T71	217
0.10	
	218

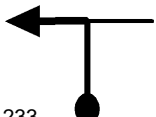
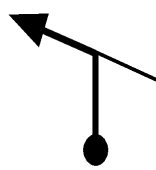
0.42	
	219
0.44	
	220
0.55	
	221
BAMP	
0.64	
V 24 02.19.01	
T72	222
0.82	
V 30 02.19.28	
T73	223
0.94	
	224
1.03	
	225

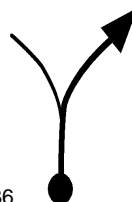
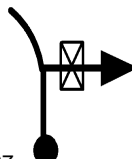
1.25	
	226
1.30	
	227
1.48	
	228
1.61	
	229
1.87	
V 32 02.21.34	
T74	230
2.44	
	231
3.05	
	232

3.62	
	233
3.67	
0.00	
N 2' 02.24.57	
T75	234
0.00	
V 42 02.26.57	
T76	235
PRINCIPAL	
0.05	
	236
MORRO SECO	
2.00	
V 39 02.29.48	
T77	237
2.48	
	238
3.03	
V 27 02.31.23	
T78	239



3.12	
V 29 02.31.35	
T79	240





3.39	
	241

3.85	
V 20 02.33.06	
T80	242

3.96	
V 19 02.33.26	
T81	243

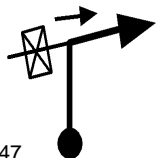
4.00	
	244

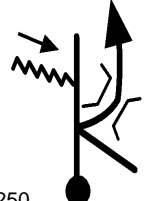
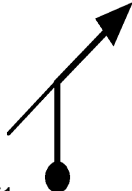
4.52	
V 27 02.35.12	
T82	245

4.98	***** 
	246
5.01	
N2'30s 02.36.17	
T83	247
5.01	
V 39 02.38.47	
T84	248
5.46	
	249
6.00	
V 33 02.40.18	
T85	250
6.09	
	251
6.24	
	252

PICO DA TRILHA

VISUAL

ENTRE A SERRA E O MAR

6.48

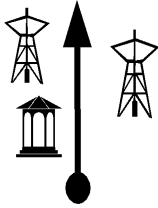

0.00

N 5' 02.41.11

T86 253

DESLOCAMENTO

0.00



D 2' 02.46.11

T87 254

DESCE FORTE

0.08



255

FIM DESLOCAMENTO

0.15

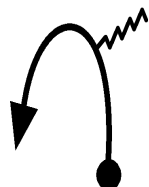

V 30 02.48.11

T88 256

0.30





257



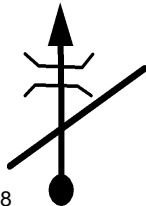

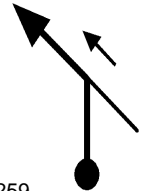
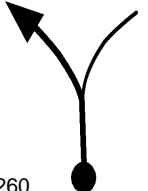
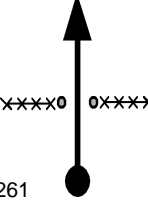
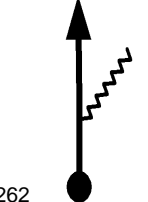
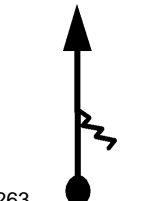

POR BAIXO DA PONTE







0.72

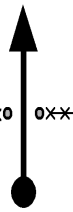

258

0.76	
	259
0.84	
	260
1.08	
V 34 02.50.02	
T89	261
1.14	
	262
1.34	
	263
1.36	
V 36 02.50.32	
T90	264
1.52	
	265

1.86	
V 30 02.51.22	
T91	266
1.97	
	267
2.00	
	268
2.03	
	269
2.07	
	270
2.16	
V 36 02.51.58	
T92	271
2.32	
	272

2.66		273
2.68		274
N 1' 02.52.50		
T93		
2.68		275
V 33 02.53.50		
T94		
2.77		276
V 42 02.54.00		
T95		
3.12		277
4.03		278
V 15 02.55.48		
T96		
4.28		279
V 39 02.56.48		
T97		

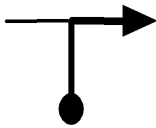
4.33	
0.00	
N2'30s 02.56.52	
T98	280

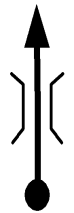

PELA PRINCIPAL

0.00	
V 42 02.59.22	
T99	

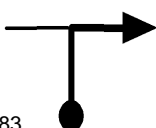
1.27	
	282

1.78	
	283

PARABENS..

2.03	 
	284

FIM DE PROVA !!



www.t15.com.br

Tempo de Prova

45 - DUPLA - ESTRE 03:02:16

FIM