

INICIO

MÉDIA A

MÉDIA B

MÉDIA C

2ª ENDURO DO TAQUARI
22/07/2017



IMPORTANTE



CUIDADO



ATENÇÃO



MUITA ATENÇÃO

Tempo de Prova

MÉDIA A 02:55:42

MÉDIA B 02:57:58

MÉDIA C 03:02:43





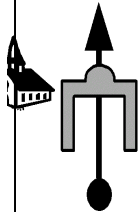

AFERIÇÃO

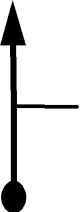

0.00

1

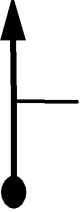

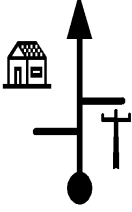
AFER



	0.10	
	2	AFER
	0.89	
	3	AFER
	1.05	
	4	AFER
	1.37	
	5	AFER
	1.48	
	6	AFER
NO POSTE		
	1.76	
	7	AFER



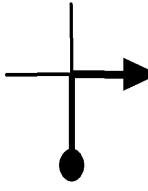
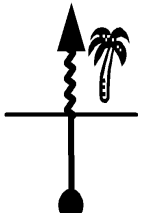
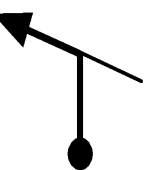
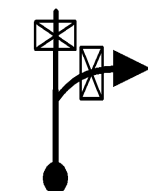
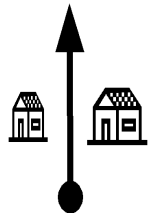



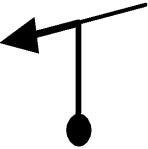
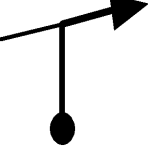

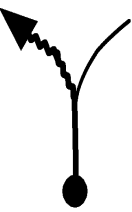
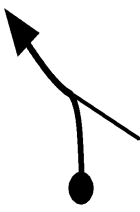
INICIO DE PROVA

	0.00
	V 39 00.00.00
	V 39 00.00.00
	V 39 00.00.00
	8 T1
	0.10
	V 39
	V 39
	V 39 00.00.09
	9 T1
	0.89
	V 39
	V 39
	V 39 00.01.22
	10 T1
	1.05
	V 39 00.01.37
	V 36 00.01.37
	V 33 00.01.37
	11 T2
	1.39
	V 39
	V 36
	V 33 00.02.14
	12 T2

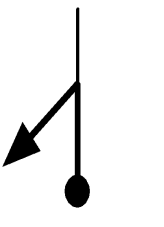
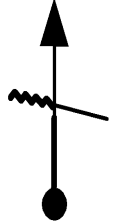
	1.59	
	V 33	00.02.27
	V 30	00.02.31
	V 27	00.02.36
	13	T3
	1.86	
	V 33	
	V 30	
	V 27	00.03.12
	14	T3
	1.87	
	V 27	00.02.57
	V 24	00.03.05
	V 21	00.03.13
	15	T4
	1.98	
	0.00	
	V 27	00.03.12
	V 24	00.03.21
	V 21	00.03.32
16	T5	
	0.06	
	V 27	
	V 24	
	V 21	00.03.42
	17	T5
entre no mato		
siga bamp		
	0.12	
	V 24	00.03.28
	V 21	00.03.39
	V 18	00.03.53
	18	T6

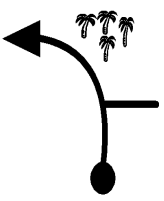
	0.25	
	V 33	00.03.47
	V 30	00.04.01
	V 27	00.04.19
	19	T7
	0.64	
	V 33	
	V 30	
	V 27	00.05.11
	20	T7
	0.67	
	V 33	
	V 30	
	V 27	00.05.15
	21	T7
baixe a cabeça		
	0.77	
	V 33	
	V 30	
	V 27	00.05.28
	22	T7
	1.04	
	V 33	
	V 30	
	V 27	00.06.04
	23	T7
	1.16	
	V 33	
	V 30	
	V 27	00.06.20
	24	T7

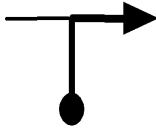
	1.23	
	V 36	00.05.34
	V 33	00.05.59
	V 30	00.06.29
	25	T8
	1.29	
	V 36	
	V 33	
	V 30	00.06.36
	26	T8
	1.34	
	V 36	
	V 33	
	V 30	00.06.42
	27	T8
	1.36	
	V 36	
	V 33	
	V 30	00.06.45
	28	T8
	1.59	
	V 36	
	V 33	
	V 30	00.07.12
	29	T8
	1.64	
	V 36	
	V 33	
	V 30	00.07.18
	30	T8

	1.71
	V 36
	V 33
	V 30 00.07.27
	31 T8
	1.76
	V 36
	V 33
	V 30 00.07.33
	32 T8
	2.00
	V 36
	V 33
	V 30 00.08.02
	33 T8
	2.11
	V 36
	V 33
	V 30 00.08.15
	34 T8
cuidado	
	
	2.24
	N 3' 00.07.15
	N2'30s 00.07.49
	N 2' 00.08.30
	35 T9
	2.24
	V 36 00.10.15
	V 33 00.10.19
	V 30 00.10.30
	36 T10

	2.28
	V 36
	V 33
	V 30 00.10.35
	37 T10

	2.33
	V 36
	V 33
	V 30 00.10.41
	38 T10







sigabamp

	2.43
	V 36
	V 33
	V 30 00.10.53
	39 T10

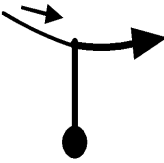
	2.44
	V 36
	V 33
	V 30 00.10.54
	40 T10



	2.52
	V 36
	V 33
	V 30 00.11.04
	41 T10

	2.53
	V 36
	V 33
	V 30 00.11.05
	42 T10

	2.59	
	V 36	
	V 33	
	V 30	00.11.12
	43	T10
	2.69	
	V 36	
	V 33	
	V 30	00.11.24
	44	T10
	2.84	
	V 27	00.11.15
	V 24	00.11.25
	V 21	00.11.42
	45	T11
	3.07	
	V 36	00.11.46
	V 33	00.11.59
	V 30	00.12.22
	46	T12
	3.16	
	V 36	
	V 33	
	V 30	00.12.33
	47	T12
	3.32	
	V 36	
	V 33	
	V 30	00.12.52
	48	T12

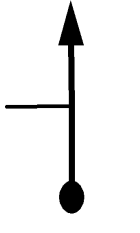
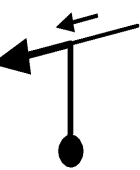
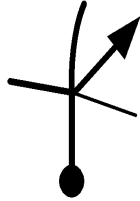

	3.45
	V 36
	V 33
	V 30 00.13.07
	49 T12
	3.55
	V 36
	V 33
	V 30 00.13.19
	50 T12
	3.81
	V 36
	V 33
	V 30 00.13.51
	51 T12
	4.28
	V 36
	V 33
	V 30 00.14.47
	52 T12
	4.43
	V 36
	V 33
	V 30 00.15.05
	53 T12
	4.55
	V 36
	V 33
	V 30 00.15.19
	54 T12

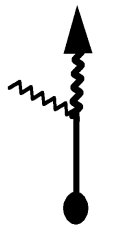
	4.72
	V 36
	V 33
	V 30 00.15.40
	55 T12
	4.80
	V 36
	V 33
	V 30 00.15.49
	56 T12
	4.86
	V 36
	V 33
	V 30 00.15.57
	57 T12
	4.94
	V 36
	V 33
	V 30 00.16.06
	58 T12
	5.22
	V 36
	V 33
	V 30 00.16.40
	59 T12
	5.28
	V 36
	V 33
	V 30 00.16.47
	60 T12

	5.42	
	V 36	
	V 33	
	V 30	00.17.04
	61	T12
	5.54	
	V 36	
	V 33	
	V 30	00.17.18
	62	T12
	5.61	
	V 36	
	V 33	
	V 30	00.17.27
	63	T12
entre no mato		
	5.70	
	0.00	
	N 3'	00.16.09
	N 2'30s	00.16.46
	N 2'	00.17.37
	64	T13
	0.00	
	0.00	
	V 30	00.19.09
	V 27	00.19.16
	V 24	00.19.37
	65	T14
	0.16	
	V 30	
	V 27	
	V 24	00.20.01
	66	T14

	0.28
	V 18 00.19.43
	V 15 00.19.53
	V 12 00.20.19
	67 T15
	0.32
	V 18
	V 15
	V 12 00.20.31
	68 T15
	0.38
	V 18
	V 15
	V 12 00.20.49
	69 T15
	0.50
	V 30 00.20.27
	V 27 00.20.46
	V 24 00.21.25
	70 T16
	0.58
	V 30
	V 27
	V 24 00.21.37
	71 T16
BAIXE A CABEÇA	
	0.72
	V 30
	V 27
	V 24 00.21.58
	72 T16

	0.87	
	V 30	
	V 27	
	V 24	00.22.21
	73	T16
	0.92	
	V 30	
	V 27	
	V 24	00.22.28
	74	T16
	1.07	
	V 30	
	V 27	
	V 24	00.22.51
	75	T16
	V 33	00.21.42
	V 30	00.22.10
	V 27	00.23.00
	76	T17
		1.29
V 33		
V 30		
V 27		00.23.21
77		T17
	1.37	
	V 33	
	V 30	
	V 27	00.23.32
	78	T17

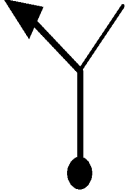
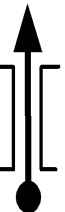
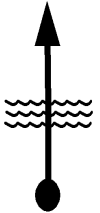
	1.53	
	V 33	
	V 30	
	V 27	00.23.53
	79	T17
ENTRE NO MATO		
	1.59	
	V 30	00.22.32
	V 27	00.23.05
	V 24	00.24.01
	80	T18
	1.82	
	0.00	
	V 24	00.23.00
	V 21	00.23.36
	V 18	00.24.36
	81	T19
CUIDADO		
PONTE ESTREITA		
	0.21	
	V 18	00.23.32
	V 15	00.24.12
	V 12	00.25.18
	82	T20
	0.67	
	V 18	
	V 15	
	V 12	00.27.36
	83	T20

cuidado

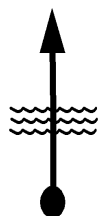

0.73

V 18

V 15

V 12 00.27.54

84

T20

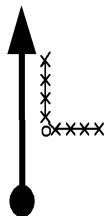

0.81

V 18

V 15

V 12 00.28.18

85

T20

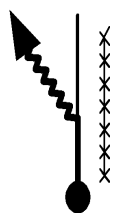

0.84

V 36 00.25.38

V 33 00.26.43

V 30 00.28.27

86

T21



1.04

V 36

V 33

V 30 00.28.51

87

T21

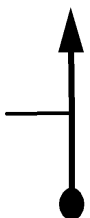

1.22

N 3' 00.26.16

N 3' 00.27.25

N 3' 00.29.12

88

T22



1.22

V 33 00.29.16

V 30 00.30.25

V 27 00.31.42

89

T23

	1.42
	V 33
	V 30
	V 27 00.32.09
	90 T23
	1.47
	V 33
	V 30
	V 27 00.32.16
	91 T23
	1.58
	V 33
	V 30
	V 27 00.32.30
	92 T23
	1.61
	0.00
	V 39 00.29.58
	V 39 00.31.11
	V 39 00.32.34
	93 T24
	0.97
	V 39
	V 39
	V 39 00.34.04
	94 T24
	2.18
	V 39
	V 39
	V 39 00.35.56
	95 T24

	3.15	
	V 39	
	V 39	
	V 39	00.37.25
	96	T24
	3.91	
	V 39	
	V 39	
	V 39	00.38.35
	97	T24
	3.93	
	V 33	00.36.01
	V 30	00.37.14
	V 27	00.38.37
	98	T25
	4.12	
	V 33	
	V 30	
	V 27	00.39.02
	99	T25
	4.27	
	V 39	00.36.38
	V 36	00.37.55
	V 33	00.39.22
	100	T26
	4.48	
	V 39	
	V 36	
	V 33	00.39.45
	101	T26

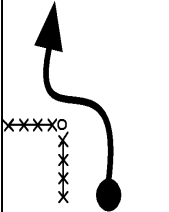
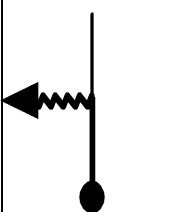
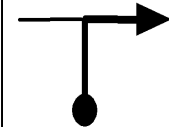
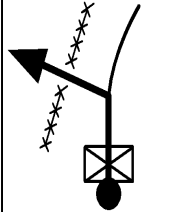
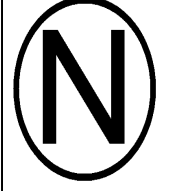
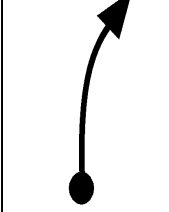
	4.77	
	V 39	
	V 36	
	V 33	00.40.17
	102	T26
entre no mato		
	4.95	
	V 33	00.37.41
	V 30	00.39.03
	V 27	00.40.37
	103	T27
	5.16	
	V 33	
	V 30	
	V 27	00.41.05
	104	T27
	5.22	
	N1'30s	00.38.10
	N1'30s	00.39.35
	N 1'	00.41.13
	105	T28
	5.22	
	V 27	00.39.40
	V 27	00.41.05
	V 27	00.42.13
	106	T29
	5.28	
	V 27	
	V 27	
	V 27	00.42.21
	107	T29

	5.35	
	V 27	
	V 27	
	V 27	00.42.30
	108	T29
	5.38	
	V 24	00.40.01
	V 21	00.41.27
	V 18	00.42.34
	109	T30
	5.48	
	V 24	
	V 21	
	V 18	00.42.54
	110	T30
cuidado degrau pedra		
PERIGO		
	5.58	
	V 24	
	V 21	
	V 18	00.43.14
	111	T30
	5.92	
	V 24	
	V 21	
	V 18	00.44.22
	112	T30
	6.18	
	V 24	
	V 21	
	V 18	00.45.14
	113	T30



	6.26	
	V 33	00.42.13
	V 30	00.43.58
	V 27	00.45.30
	114	T31
	6.40	
	N 3'	00.42.29
	N 2'30"	00.44.14
	N 2'	00.45.49
	115	T32
	6.40	
	V 36	00.45.29
	V 33	00.46.44
	V 30	00.47.49
	116	T33
	6.68	
	V 36	
	V 33	
	V 30	00.48.22
	117	T33
	6.71	
	V 24	00.46.00
	V 21	00.47.18
	V 18	00.48.26
	118	T34
	6.87	
	V 30	00.46.24
	V 27	00.47.46
	V 24	00.48.58
	119	T35



	7.60	
	V 39	00.47.51
	V 39	00.49.23
	V 39	00.50.47
	120	T36
	7.96	
	V 39	
	V 39	
	V 39	00.51.21
	121	T36
	8.74	
	V 33	00.49.37
	V 30	00.51.08
	V 27	00.52.33
	122	T37
	8.77	
	V 33	
	V 30	
	V 27	00.52.37
	123	T37
	8.80	
	V 33	
	V 30	
	V 27	00.52.41
	124	T37



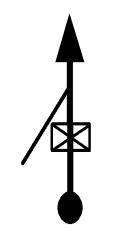
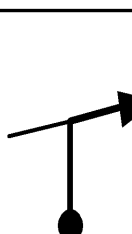

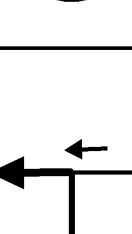
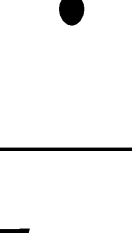
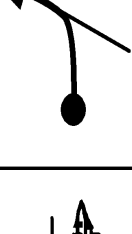
	8.96	
	V 36	00.50.01
	V 33	00.51.34
	V 30	00.53.02
	125	T38
	9.01	
	V 36	
	V 33	
	V 30	00.53.08
	126	T38
	9.04	
	V 36	
	V 33	
	V 30	00.53.12
	127	T38
	9.40	
	V 33	00.50.45
	V 30	00.52.22
	V 27	00.53.55
	128	T39
	9.48	
	V 33	
	V 30	
	V 27	00.54.05
	129	T39
	9.74	
	V 33	
	V 30	
	V 27	00.54.40
	130	T39



	9.76	
	V 36	00.51.24
	V 33	00.53.06
	V 30	00.54.43
	131	T40
	9.90	
	V 36	
	V 33	
	V 30	00.55.00
	132	T40
	10.05	
	V 36	
	V 33	
	V 30	00.55.18
	133	T40
	10.09	
	V 36	
	V 33	
	V 30	00.55.22
	134	T40
	10.22	
	V 36	
	V 33	
	V 30	00.55.38
	135	T40
	10.27	
	V 36	
	V 33	
	V 30	00.55.44
	136	T40

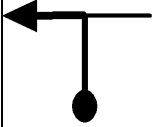

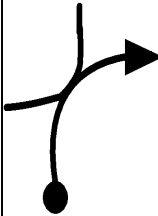

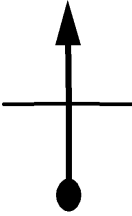
	10.49
	V 36
	V 33
	V 30 00.56.10
	137 T40
	10.51
	N 2' 00.52.39
	N1'30s 00.54.28
	N1'30s 00.56.13
	138 T41
	10.51
	V 39 00.54.39
	V 39 00.55.58
	V 39 00.57.43
	139 T42
	10.78
	0.00
	V 39 00.55.04
	V 39 00.56.22
	V 39 00.58.08
140 T43	
	1.22
	V 39
	V 39
	V 39 01.00.00
	141 T43
	2.17
	V 39
	V 39
	V 39 01.01.28
	142 T43

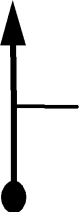
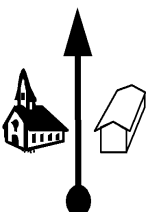

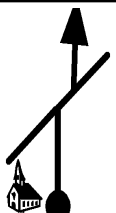
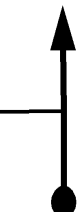
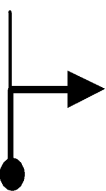

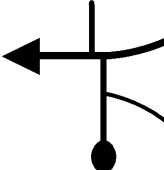
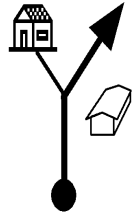
	2.65	
	V 39	
	V 39	
	V 39	01.02.12
	143	T43
	2.90	
	V 39	
	V 39	
	V 39	01.02.35
	144	T43
	3.47	
	V 36	01.00.24
	V 33	01.01.43
	V 30	01.03.28
	145	T44
	3.94	
	V 18	01.01.11
	V 15	01.02.34
	V 15	01.04.24
	146	T45
	4.51	
	V 18	
	V 15	
	V 15	01.06.41
	147	T45
	4.53	
	V 18	
	V 15	
	V 15	01.06.46
	148	T45

pelo rio	
	4.61
	V 18
	V 15
	V 15 01.07.05
	149 T45
	4.64
	V 18
	V 15
	V 15 01.07.12
	150 T45
saia do rio	
	4.66
	V 27 01.03.35
	V 24 01.05.27
	V 21 01.07.17
	151 T46
	4.96
	V 27
	V 24
	V 21 01.08.09
	152 T46
	5.05
	V 27
	V 24
	V 21 01.08.24
	153 T46
	5.09
	V 27
	V 24
	V 21 01.08.31
	154 T46

	5.45	
	N 3'	01.05.20
	N2'30s	01.07.25
	N 2'	01.09.33
	155	T47
	5.45	
	V 39	01.08.20
	V 39	01.09.55
	V 39	01.11.33
	156	T48
	5.96	
	V 39	
	V 39	
	V 39	01.12.20
	157	T48
	7.08	
	V 39	
	V 39	
	V 39	01.14.03
	158	T48
	7.44	
	V 39	
	V 39	
	V 39	01.14.36
	159	T48
	7.88	
	V 39	
	V 39	
	V 39	01.15.17
	160	T48

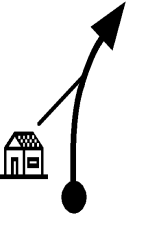
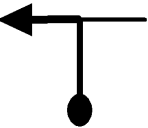
	8.76	
	V 39	
	V 39	
	V 39	01.16.38
	161	T48
apoio		
zerar no poste		
	9.13	
	0.00	
	N 15'	01.14.00
	N 15'	01.15.35
	N 15'	01.17.12
162	T49	
	0.00	
	V 39	01.29.00
	V 39	01.30.35
	V 39	01.32.12
	163	T50
	0.03	
	V 39	
	V 39	
	V 39	01.32.15
	164	T50
	0.88	
	V 39	
	V 39	
	V 39	01.33.33
	165	T50
	1.58	
	V 33	01.31.26
	V 30	01.33.01
	V 27	01.34.38
	166	T51

	2.17	
	V 21	01.32.30
	V 18	01.34.12
	V 15	01.35.57
	167	T52
	2.28	
	V 39	01.32.49
	V 37	01.34.34
	V 34	01.36.23
	168	T53
	2.49	
	V 39	
	V 37	
	V 34	01.36.45
	169	T53
	2.86	
	V 39	
	V 37	
	V 34	01.37.25
	170	T53
RIO COM PEDRAS		
	3.08	
	V 21	01.34.03
	V 18	01.35.51
	V 15	01.37.48
	171	T54
	3.29	
	V 24	01.34.39
	V 24	01.36.33
	V 24	01.38.38
	172	T55

	3.41
	V 24
	V 24
	V 24 01.38.56
	173 T55
	3.46
	N2'30s 01.35.04
	N 2' 01.36.59
	N 2' 01.39.04
	174 T56
	3.46
	V 39 01.37.34
	V 39 01.38.59
	V 39 01.41.04
	175 T57
	3.87
	V 39
	V 39
	V 39 01.41.42
	176 T57
	4.17
	V 18 01.38.40
	V 18 01.40.04
	V 18 01.42.09
	177 T58
	4.26
	V 18
	V 18
	V 18 01.42.27
	178 T58

	4.33	
	V 30	01.39.12
	V 27	01.40.36
	V 24	01.42.41
	179	T59







	4.45	
	V 30	
	V 27	
	V 24	01.42.59
	180	T59

	4.46	
	V 27	01.39.28
	V 24	01.40.54
	V 21	01.43.01
	181	T60

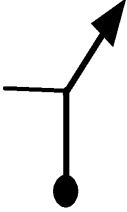
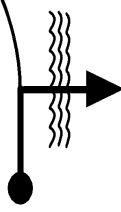
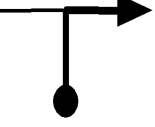
	4.52	
	V 27	
	V 24	
	V 21	01.43.11
	182	T60

	4.91	
	V 18	01.40.28
	V 15	01.42.01
	V 15	01.44.18
	183	T61

	5.19	
	V 21	01.41.24
	V 18	01.43.09
	V 15	01.45.25
	184	T62
	5.45	
	V 21	
	V 18	
	V 15	01.46.28
	185	T62
	5.49	
	V 21	
	V 18	
	V 15	01.46.37
	186	T62
	5.57	
	N2'30s	01.42.29
	N2'30s	01.44.25
	N2'30s	01.46.56
	187	T63
	5.57	
	V 30	01.44.59
	V 30	01.46.55
	V 30	01.49.26
	188	T64
	5.84	
	V 30	
	V 30	
	V 30	01.49.59
	189	T64

	5.98	
	V 42	01.45.48
	V 42	01.47.44
	V 42	01.50.16
	190	T65

	6.71	
	V 39	01.46.50
	V 36	01.48.46
	V 33	01.51.18
	191	T66

	6.79	
	V 39	
	V 36	
	V 33	01.51.27
	192	T66





	7.04	
	V 39	
	V 36	
	V 33	01.51.54
	193	T66

SUBIDA COM MUITA EROSÃO

MUITO CUIDADO

	7.20	
	V 21	01.47.36
	V 18	01.49.35
	V 15	01.52.12
	194	T67

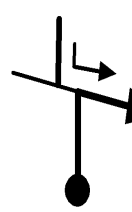
	7.50	
	V 21	
	V 18	
	V 15	01.53.24
	195	T67

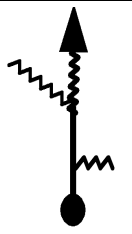
	7.99	
	N2'30s	01.49.51
	N2'30s	01.52.13
	N2'30s	01.55.21
	196	T68
	7.99	
	V 30	01.52.21
	V 30	01.54.43
	V 30	01.57.51
	197	T69
	8.28	
	V 39	01.52.56
	V 39	01.55.18
	V 39	01.58.26
	198	T70
	9.27	
	0.00	
	V 39	01.54.27
	V 39	01.56.49
	V 39	01.59.57
199	T71	
	0.13	
	V 30	01.54.39
	V 27	01.57.01
	V 24	02.00.09
	200	T72
	0.22	
	V 18	01.54.50
	V 15	01.57.13
	V 12	02.00.23
	201	T73

	0.38	
	V 30	01.55.22
	V 27	01.57.52
	V 24	02.01.11
202	T74	

	0.64	
	V 36	01.55.53
	V 33	01.58.27
	V 30	02.01.50
203	T75	







	0.88	
	V 36	
	V 33	
	V 30	02.02.19
204	T75	



	1.05	
	V 36	
	V 33	
	V 30	02.02.39
205	T75	



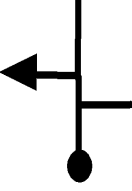

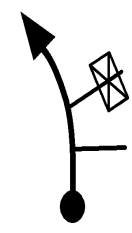

	1.33	
	V 30	01.57.02
	V 27	01.59.42
	V 24	02.03.13
206	T76	

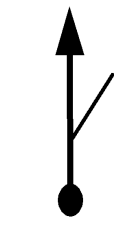
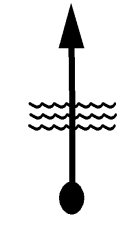
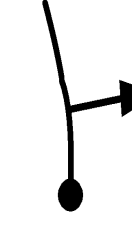
	1.73	
	V 36	01.57.50
	V 33	02.00.35
	V 30	02.04.13
207	T77	

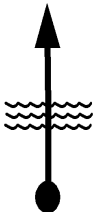
	2.02	
	V 36	
	V 33	
	V 30	02.04.47
	208	T77
	2.19	
	V 18	01.58.36
	V 15	02.01.25
	V 12	02.05.08
	209	T78
	2.31	
	V 36	01.59.00
	V 33	02.01.54
	V 30	02.05.44
	210	T79
	2.40	
	V 36	
	V 33	
	V 30	02.05.55
	211	T79
	2.75	
	V 36	
	V 33	
	V 30	02.06.37
	212	T79
	2.88	
	N2'30s	01.59.57
	N 2'	02.02.56
	N 2'	02.06.52
	213	T80

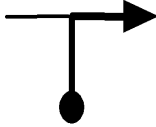
	2.88
	V 27 02.02.27
	V 27 02.04.56
	V 27 02.08.52
214	T81
	2.94
	V 27
	V 27
	V 27 02.09.00
215	T81
	3.27
	V 39 02.03.19
	V 39 02.05.48
	V 39 02.09.44
216	T82
	3.77
	V 39
	V 39
	V 39 02.10.30
217	T82
	3.89
	0.00
	V 39 02.04.17
	V 39 02.06.46
V 39 02.10.41	
218	T83
	0.11
	V 39
	V 39
	V 39 02.10.52
219	T83

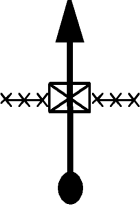
	0.77	
	V 39	
	V 39	
	V 39	02.11.52
	220	T83
	0.97	
	V 42	02.05.46
	V 39	02.08.15
	V 36	02.12.11
	221	T84
	1.43	
	V 42	
	V 39	
	V 36	02.12.57
	222	T84
	1.48	
	V 42	
	V 39	
	V 36	02.13.02
	223	T84
	1.84	
	V 42	
	V 39	
	V 36	02.13.38
	224	T84
	1.99	
	V 39	02.07.13
	V 36	02.09.49
	V 33	02.13.53
	225	T85

	2.08	
	V 39	
	V 36	
	V 33	02.14.03
226	T85	
	2.44	
	V 39	
	V 36	
	V 33	02.14.42
227	T85	
	2.74	
	V 39	
	V 36	
	V 33	02.15.15
228	T85	
	2.89	
	V 33	02.08.37
	V 30	02.11.19
	V 27	02.15.31
229	T86	
	3.05	
	V 33	
	V 30	
	V 27	02.15.52
230	T86	
	3.28	
	V 33	
	V 30	
	V 27	02.16.23
231	T86	

	3.29	
	N 3'	02.09.20
	N 2'30"	02.12.07
	N 2'	02.16.24
	232	T87
	3.29	
	V 39	02.12.20
	V 39	02.14.37
	V 39	02.18.24
	233	T88
	3.81	
	V 36	02.13.08
	V 33	02.15.25
	V 30	02.19.12
	234	T89
	4.45	
	V 36	
	V 33	
	V 30	02.20.29
	235	T89
	4.60	
	V 36	
	V 33	
	V 30	02.20.47
	236	T89
	4.74	
	V 36	
	V 33	
	V 30	02.21.04
	237	T89

CUIDADO PEDRA

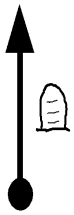

4.76

V 30 02.14.43

V 27 02.17.09

V 24 02.21.06

238

T90

CUIDADO TOCO



4.77

V 36 02.14.44

V 33 02.17.10

V 30 02.21.08

239

T91

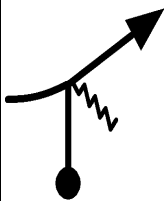

4.91

V 36

V 33

V 30 02.21.25

240

T91



4.96

V 36

V 33

V 30 02.21.31

241

T91

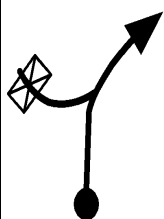

5.06



V 36

V 33

V 30 02.21.43

242

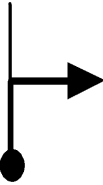
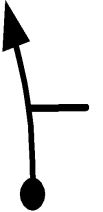
T91

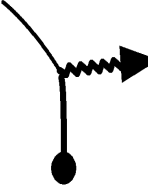
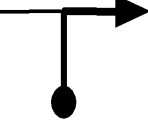
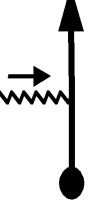
	5.22	
	V 36	
	V 33	
	V 30	02.22.02
	243	T91
	5.30	
	V 36	
	V 33	
	V 30	02.22.12
	244	T91
	5.90	
	V 36	
	V 33	
	V 30	02.23.24
	245	T91
	5.96	
	0.00	
	V 36	02.16.43
	V 33	02.19.20
	V 30	02.23.31
246	T92	
	0.15	
	V 36	
	V 33	
	V 30	02.23.49
	247	T92
	0.32	
	V 36	
	V 33	
	V 30	02.24.09
	248	T92

	0.46	
	V 36	
	V 33	
	V 30	02.24.26
249	T92	

CUIDADO PEDRA

	0.49	
	V 30	02.17.32
	V 27	02.20.13
	V 24	02.24.30
250	T93	





CUIDADO TOCO

	0.50	
	V 36	02.17.34
	V 33	02.20.15
	V 30	02.24.31
251	T94	

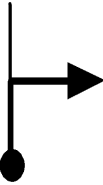
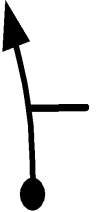

	0.63	
	V 36	
	V 33	
	V 30	02.24.47
252	T94	

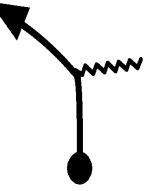
	0.68	
	V 36	
	V 33	
	V 30	02.24.53
253	T94	

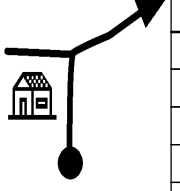

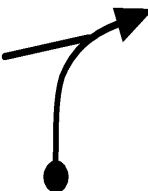
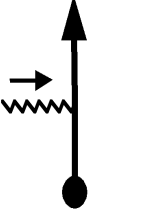
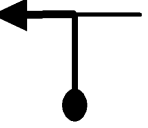
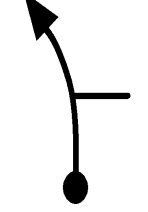
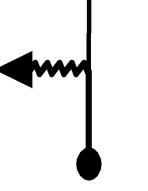
	0.78	
	V 36	
	V 33	
	V 30	02.25.05
254	T94	

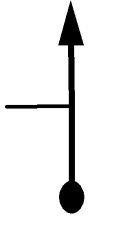
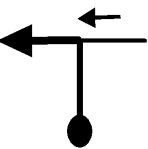
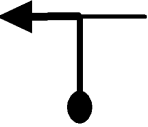
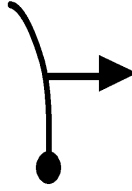

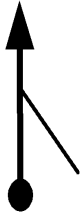
	0.95	
	V 36	
	V 33	
	V 30	02.25.25
	255	T94
	1.02	
	V 36	
	V 33	
	V 30	02.25.33
	256	T94
	1.62	
	V 36	
	V 33	
	V 30	02.26.45
	257	T94
	1.68	
	V 36	
	V 33	
	V 30	02.26.53
	258	T94
	1.74	
	V 36	
	V 33	
	V 30	02.27.00
	259	T94
	1.84	
	N 3'	02.19.48
	N2'30"	02.22.41
	N 2'	02.27.12
	260	T95

	1.84	
	V 39	02.22.48
	V 39	02.25.11
	V 39	02.29.12
	261	T96
	2.11	
	V 39	
	V 39	
	V 39	02.29.37
	262	T96
	2.17	
	V 39	
	V 39	
	V 39	02.29.42
	263	T96
	2.41	
	V 39	
	V 39	
	V 39	02.30.04
	264	T96
	2.47	
	V 39	
	V 39	
	V 39	02.30.10
	265	T96
	2.70	
	V 36	02.24.07
	V 33	02.26.30
	V 30	02.30.31
	266	T97

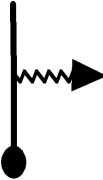
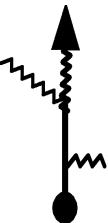
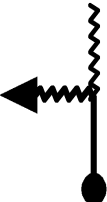
	2.75	
	V 36	
	V 33	
	V 30	02.30.37
	267	T97
	3.01	
	V 39	02.24.38
	V 39	02.27.04
	V 39	02.31.08
	268	T98
	3.25	
	V 39	
	V 39	
	V 39	02.31.31
	269	T98
	3.30	
	N 2'	02.25.05
	N1'30s	02.27.31
	N1'30s	02.31.35
	270	T99
	3.30	
	V 39	02.27.05
	V 39	02.29.01
	V 39	02.33.05
	271	T100
	3.87	
	V 39	
	V 39	
	V 39	02.33.58
	272	T100

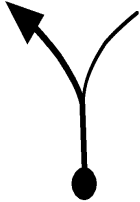
	4.02	
	V 42	02.28.11
	V 39	02.30.07
	V 36	02.34.12
	273	T101
	4.47	
	V 36	02.28.50
	V 33	02.30.49
	V 30	02.34.57
	274	T102
	4.50	
	V 36	
	V 33	
	V 30	02.35.00
	275	T102
	4.72	
	V 33	02.29.15
	V 30	02.31.16
	V 27	02.35.27
	276	T103
	5.28	
	V 39	02.30.16
	V 36	02.32.23
	V 33	02.36.41
	277	T104
	6.10	
	0.00	
	N2'30s	02.31.32
	N 2'	02.33.45
	N1'30s	02.38.11
278	T105	

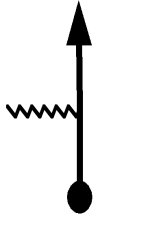
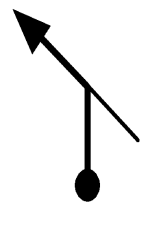
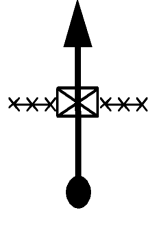
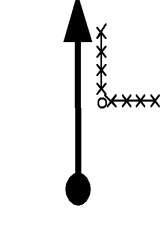
	0.00
	V 39 02.34.02
	V 39 02.35.45
	V 39 02.39.41
	279 T106
	0.13
	V 30 02.34.14
	V 27 02.35.57
	V 24 02.39.53
	280 T107
	0.23
	V 15 02.34.26
	V 15 02.36.11
	V 12 02.40.08
	281 T108
	0.39
	V 30 02.35.04
	V 27 02.36.49
	V 24 02.40.56
	282 T109
	0.65
	0.00
	V 36 02.35.35
	V 33 02.37.24
	V 30 02.41.35
283 T110	
	0.23
	V 36
	V 33
	V 30 02.42.02
	284 T110

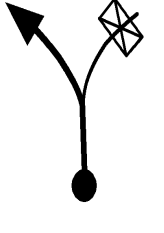
	0.40	
	V 36	
	V 33	
	V 30	02.42.23
	285	T110
	0.69	
	V 36	
	V 33	
	V 30	02.42.58
	286	T110
	1.20	
	V 36	
	V 33	
	V 30	02.43.59
	287	T110
	1.52	
	N 2'	02.38.07
	N 2'	02.40.10
	N 2'	02.44.37
	288	T111
	1.52	
	V 30	02.40.07
	V 30	02.42.10
	V 30	02.46.37
	289	T112
	2.01	
	V 30	
	V 30	
	V 30	02.47.36
	290	T112

	2.09	
	V 39	02.41.16
	V 39	02.43.18
	V 39	02.47.46
	291	T113

	2.17	
	V 39	
	V 39	
	V 39	02.47.53
	292	T113

	2.72	
	V 39	
	V 39	
	V 39	02.48.44
	293	T113

	3.07	
	V 36	02.42.46
	V 33	02.44.48
	V 30	02.49.16
	294	T114

CUIDADO DESCIDA COM EROSÕES

	3.46	
	V 33	02.43.25
	V 30	02.45.31
	V 27	02.50.03
	295	T115

	3.52	
	V 33	
	V 30	
	V 27	02.50.11
	296	T115

	3.60	
	V 33	
	V 30	
	V 27	02.50.22
	297	T115
	3.76	
	V 33	
	V 30	
	V 27	02.50.43
	298	T115
	3.82	
	V 36	02.44.04
	V 33	02.46.14
	V 30	02.50.51
	299	T116
	3.96	
	V 36	
	V 33	
	V 30	02.51.08
	300	T116
	4.01	
	V 36	
	V 33	
	V 30	02.51.14
	301	T116

	4.07	
	V 36	
	V 33	
	V 30	02.51.21
	302	T116
	4.14	
	V 36	
	V 33	
	V 30	02.51.29
	303	T116
	4.32	
	V 36	
	V 33	
	V 30	02.51.51
	304	T116
	4.38	
	V 36	
	V 33	
	V 30	02.51.58
	305	T116
	4.45	
	V 36	
	V 33	
	V 30	02.52.06
	306	T116
	4.58	
	0.00	
	N 2'	02.45.20
	N 2'	02.47.37
	N 2'	02.52.22
	307	T117

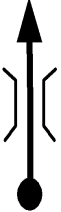
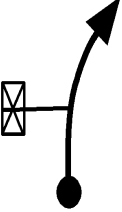
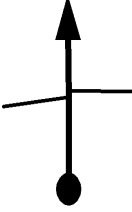
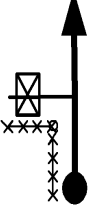
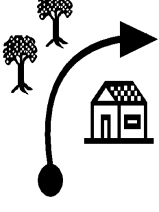
	0.00
	V 42 02.47.20
	V 42 02.49.37
	V 42 02.54.22
	308 T118
	0.44
	V 42
	V 42
	V 42 02.55.00
	309 T118
	1.29
	V 42
	V 42
	V 42 02.56.13
	310 T118
	2.84
	V 42
	V 42
	V 42 02.58.25
	311 T118
	3.78
	V 42
	V 42
	V 42 02.59.46
	312 T118
	4.88
	V 42
	V 42
	V 42 03.01.20
	313 T118

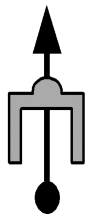

5.85

V 42 02.55.42

V 42 02.57.58

V 42 03.02.43

314 **T118**

FIM DE PROVA !!



www.t15.com.br

Tempo de Prova

MÉDIA A 02:55:42

MÉDIA B 02:57:58

MÉDIA C 03:02:43

FIM