

INICIO

MÉDIA A

MÉDIA B

MÉDIA C

ENDURO DE REGULARIDADE DE SÃO PEDRO DE ALCANTARA
11 SETEMBRO 2022



IMPORTANTE

CUIDADO

ATENÇÃO

MUITA ATENÇÃO

Tempo de Prova

MÉDIA A 03:32:34

MÉDIA B 03:33:06

MÉDIA C 03:36:08



AFERIÇÃO

Zerar no portal

CUIDADO ESTRADA

MOVIMENTADA



0.00

1 **AFER**

CUIDADO ESTRADA

MOVIMENTADA

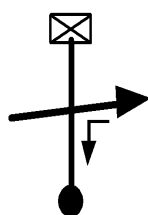

0.05

2 **AFER**

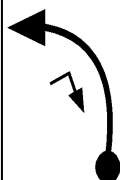

0.48

3 **AFER**

Aferir na Pedra

Volte com Cuidado

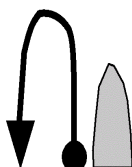

1.412
AFER

4 **AFER**

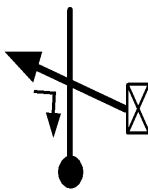

2.73

5 **AFER**

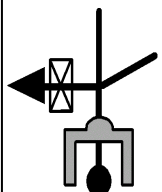

2.800
0.00

6 **AFER**



INICIO DE PROVA

Inicio

Zerar no poste



0.00

V 33 00.00.00

V 30 00.00.00

V 27 00.00.00

7 **T1**

cuidado motos

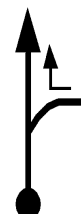

0.03

V 33

V 30

V 27 00.00.04

8 **T1**

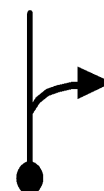

0.09

V 33

V 30

V 27 00.00.12

9 **T1**

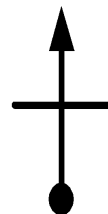

0.13

V 33

V 30

V 27 00.00.17

10 **T1**

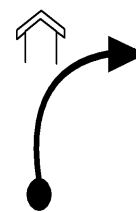



0.18





V 33

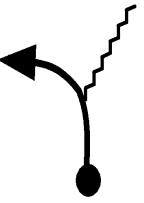
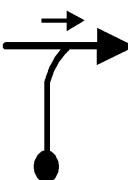

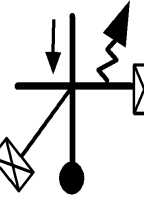

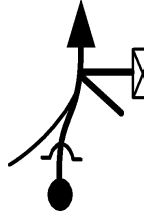
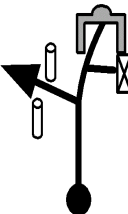
V 30

V 27 00.00.24

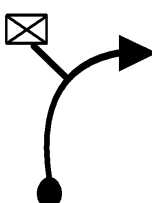



11 **T1**

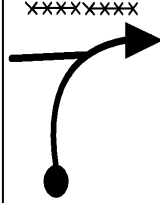
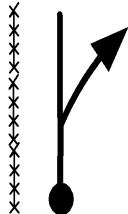



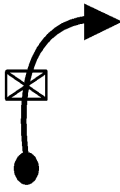
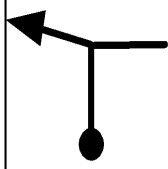

11 SETEMBRO 2022		Pág: 004	
SOBE			
	0.21		
	V 33		
	V 30		
	V 27	00.00.28	
	12	T1	
	0.22		
	V 33		
	V 30		
	V 27	00.00.29	
	13	T1	
Cuidado Motos			
	0.25		
	V 33		
	V 30		
	V 27	00.00.33	
	14	T1	
	0.30		
	V 33		
	V 30		
	V 27	00.00.40	
	15	T1	
	0.35		
	V 33		
	V 30		
	V 27	00.00.47	
	16	T1	
SOBE			
ATRAVESSE COM			
CUIDADO			
	0.62		
	V 33		
	V 30		
	V 27	00.01.23	
	17	T1	



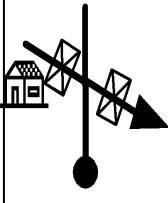

11 SETEMBRO 2022		Pág: 005	
SALTO NÃO EXAGERAR			
	0.73		
	V 33		
	V 30		
	V 27	00.01.37	
	18	T1	
	0.81		
	V 36	00.01.28	
	V 33	00.01.37	
	V 30	00.01.48	
	19	T2	
	0.84		
	N 30s	00.01.31	
	N 30s	00.01.40	
	N 30s	00.01.52	
	20	T3	
BUMP			
	0.84		
	V 36	00.02.01	
	V 33	00.02.10	
	V 30	00.02.22	
	21	T4	
	0.95		
	V 36		
	V 33		
	V 30	00.02.35	
	22	T4	
	1.21		
	V 36		
	V 33		
	V 30	00.03.06	
	23	T4	

11 SETEMBRO 2022		Pág: 006	
	1.34		
	V 36		
	V 33		
	V 30	00.03.22	
	24	T4	
SENTIDO OUTRA			
PORTEIRA			
SIGA CARREIRO			
	1.57		
	V 36		
	V 33		
	V 30	00.03.49	
	25	T4	
	1.67		
	V 36		
	V 33		
	V 30	00.04.01	
	26	T4	
	1.70		
	V 36		
	V 33		
	V 30	00.04.05	
	27	T4	
	1.76		
	V 36		
	V 33		
	V 30	00.04.12	
	28	T4	
	1.82		
	V 36		
	V 33		
	V 30	00.04.19	
	29	T4	

ENTRE NO MATO

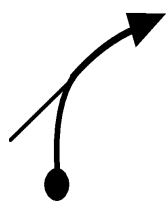
	1.88
	V 36
	V 33
	V 30 00.04.26
	30 T4
	1.92
	V 36
	V 33
	V 30 00.04.31
	31 T4
	2.02
	V 39 00.03.59
	V 36 00.04.19
	V 33 00.04.43
	32 T5
	2.34
	V 39
	V 36
	V 33 00.05.18
	33 T5
	2.80
	V 39
	V 36
	V 33 00.06.08
	34 T5
SOBE	
	2.91
	V 39
	V 36
	V 33 00.06.20
	35 T5

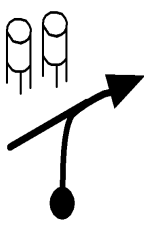
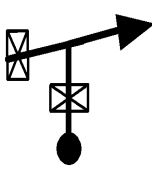
	2.97
	V 39
	V 36
	V 33 00.06.27
	36 T5
	3.25
	V 39
	V 36
	V 33 00.06.57
	37 T5
	3.70
	V 39
	V 36
	V 33 00.07.46
	38 T5
	3.77
	V 39
	V 36
	V 33 00.07.54
	39 T5
	3.82
	V 39
	V 36
	V 33 00.08.00
	40 T5
	3.90
	V 39
	V 36
	V 33 00.08.08
	41 T5
	4.20
	V 39
	V 36
	V 33 00.08.41
	42 T5

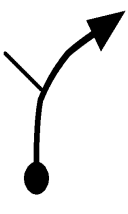
	4.27
	V 39
	V 36
	V 33 00.08.49
	43 T5
	4.41
	V 39
	V 36
	V 33 00.09.04
	44 T5
	4.51
	V 39
	V 36
	V 33 00.09.15
	45 T5
	4.65
	V 39
	V 36
	V 33 00.09.30
	46 T5
	4.75
	V 42 00.08.11
	V 39 00.08.52
	V 36 00.09.41
	47 T6
	5.09
	V 42
	V 39
	V 36 00.10.15
	48 T6
	5.34
	V 42
	V 39
	V 36 00.10.40
	49 T6

	5.51	
	V 42	
	V 39	
	V 36	00.10.57
	50	T6
	5.71	
	V 42	
	V 39	
	V 36	00.11.17
	51	T6
	5.84	
	V 42	
	V 39	
	V 36	00.11.30
	52	T6
	5.88	
	V 42	
	V 39	
	V 36	00.11.34
	53	T6
ATENÇÃO		
	5.90	
	V 17	00.09.50
	V 16	00.10.38
	V 15	00.11.36
	54	T7
	5.92	
	V 42	00.09.54
	V 39	00.10.43
	V 36	00.11.41
	55	T8
	6.04	
	V 42	
	V 39	
	V 36	00.11.53
	56	T8

	6.08	
	V 42	
	V 39	
	V 36	00.11.57
	57	T8
	6.11	
	V 42	00.10.10
	V 36	00.11.00
	V 33	00.12.00
	58	T9
	6.13	
	V 42	
	V 36	
	V 33	00.12.02
	59	T9
	6.20	
	V 42	
	V 36	
	V 33	00.12.10
	60	T9
	6.26	
	V 42	
	V 36	
	V 33	00.12.16
	61	T9
	6.36	
	V 42	
	V 36	
	V 33	00.12.27
	62	T9







	6.44	
	V 42	
	V 36	
	V 33	00.12.36
	63	T9
	6.51	
	N 4'	00.10.45
	N3'30s	00.11.40
	N 3'	00.12.43
	64	T10
	6.51	
	0.00	
	V 33	00.14.45
	V 33	00.15.10
	V 33	00.15.43
65	T11	
	0.08	
	V 33	
	V 33	
	V 33	00.15.52
	66	T11
ATRAVESSAR COM CUIDADO		
	0.21	
	V 33	
	V 33	
	V 33	00.16.06
	67	T11
	0.37	
	V 33	
	V 33	
	V 33	00.16.24
	68	T11







11 SETEMBRO 2022		Pág: 013	
	0.48	V 33	
		V 33	
		V 33	00.16.36
	69	T11	
CUIDADO CASAS			
	0.56	V 27	00.15.46
		V 27	00.16.11
		V 27	00.16.45
	70	T12	
	0.62	V 27	
		V 27	
		V 27	00.16.53
	71	T12	
	0.77	V 27	
		V 27	
		V 27	00.17.13
	72	T12	
	0.83	V 27	
		V 27	
		V 27	00.17.21
	73	T12	
	0.93	V 27	
		V 27	
		V 27	00.17.34
	74	T12	
	0.98	V 27	
		V 27	
		V 27	00.17.41
	75	T12	

11 SETEMBRO 2022		Pág: 014	
	1.15	V 39	00.17.04
		V 36	00.17.30
		V 33	00.18.03
	76	T13	
	1.20	N 30s	00.17.09
		N 30s	00.17.35
		N 30s	00.18.09
	77	T14	
	1.20	V 39	00.17.39
		V 36	00.18.05
		V 33	00.18.39
	78	T15	
	1.38	V 39	
		V 36	
		V 33	00.18.58
	79	T15	
NÃO ERRE			
	2.17	V 39	
		V 36	
		V 33	00.20.24
	80	T15	
	2.21	V 39	
		V 36	
		V 33	00.20.29
	81	T15	

11 SETEMBRO 2022		Pág: 015	
DESCE FORTE			
	2.57	V 44	00.19.46
		V 42	00.20.22
		V 39	00.21.08
	82	T16	
	2.97	V 44	
		V 42	
		V 39	00.21.45
	83	T16	
CURVA CUIDADO			
	3.05	V 44	
		V 42	
		V 39	00.21.52
	84	T16	
	3.22	V 44	
		V 42	
		V 39	00.22.08
	85	T16	
	3.78	V 44	
		V 42	
		V 39	00.23.00
	86	T16	
LOMBA NA ENTRADA			
	3.89	V 44	
		V 42	
		V 39	00.23.10
	87	T16	

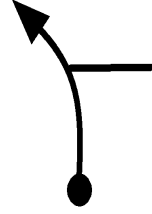
11 SETEMBRO 2022		Pág: 016	
	4.14	V 44	
		V 42	
		V 39	00.23.33
		88	T16
	CUIDADO CURVA		
			
	4.20	V 44	
		V 42	
		V 39	00.23.39
		89	T16
	CUIDADO CURVA		
	4.39	N 3'	00.22.14
		N 2'30"	00.22.58
		N 2'	00.23.56
		90	T17
	ESTRADINHA		
	4.39	V 46	00.25.14
		V 44	00.25.28
		V 42	00.25.56
		91	T18
	CUIDADO CURVA		
	4.51	V 46	
		V 44	
		V 42	00.26.06
		92	T18
	CUIDADO CURVA		
	4.70	V 46	
		V 44	
		V 42	00.26.23
		93	T18
	CUIDADO CURVA		

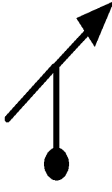
11 SETEMBRO 2022		Pág: 017	
	4.78	V 46	
		V 44	
		V 42	00.26.30
		94	T18
	CUIDADO ABISMO		
	5.05	V 44	00.26.06
		V 42	00.26.22
		V 39	00.26.53
		95	T19
	CUIDADO ABISMO		
			
	5.23	V 44	
		V 42	
		V 39	00.27.09
		96	T19
	CUIDADO ABISMO		
	5.32	N 1'	00.26.28
		N 1'	00.26.45
		N 1'	00.27.18
		97	T20
	VISUAL SANTO AMARO		
	5.32	V 33	00.27.28
		V 30	00.27.45
		V 27	00.28.18
		98	T21
	CUIDADO PRECIPICIO		
	5.38	V 36	00.27.35
		V 33	00.27.52
		V 30	00.28.26
		99	T22
	CUIDADO PRECIPICIO		

11 SETEMBRO 2022		Pág: 018	
NÃO SALTE			
	5.60	V 36	
		V 33	
		V 30	00.28.52
		100	T22
	CUIDADO ABISMO		
	5.91	V 42	00.28.28
		V 39	00.28.50
		V 36	00.29.29
		101	T23
	CUIDADO ABISMO		
	6.00	V 42	
		V 39	
		V 36	00.29.38
		102	T23
	CUIDADO ABISMO		
	6.11	N 2'	00.28.45
		N 1'30"	00.29.09
		N 1'	00.29.49
		103	T24
	O BAMBU VAI		
GEMER			
	6.11	V 57	00.30.45
		V 54	00.30.39
		V 51	00.30.49
		104	T25
	CUIDADO ABISMO		
	6.17	V 57	
		V 54	
		V 51	00.30.53
		105	T25
	CUIDADO ABISMO		

11 SETEMBRO 2022		Pág: 019	
	6.26	V 57	
		V 54	
		V 51	00.31.00
	106	T25	
	6.73	V 57	
		V 54	
		V 51	00.31.33
	107	T25	
	6.91	V 57	
		V 54	
		V 51	00.31.46
	108	T25	
CUIDADO			
	7.24		
	0.00		
		V 61	00.31.56
		V 55	00.31.54
		V 52	00.32.09
	109	T26	
LAGO			
	0.11	V 61	
		V 55	
		V 52	00.32.17
	110	T26	
CUIDADO MOTOS			
	0.22	V 61	
		V 55	
		V 52	00.32.24
	111	T26	

11 SETEMBRO 2022		Pág: 020	
	0.38	V 61	
		V 55	
		V 52	00.32.35
	112	T26	
	0.63	V 61	
		V 55	
		V 52	00.32.53
	113	T26	
SOBE			
	1.01	V 47	00.32.56
		V 44	00.33.00
		V 41	00.33.19
	114	T27	
	1.19	V 47	
		V 44	
		V 41	00.33.35
	115	T27	
CUIDADO MOTOS			
	1.60	V 42	00.33.41
		V 39	00.33.48
		V 36	00.34.11
	116	T28	
	1.69	V 42	
		V 39	
		V 36	00.34.20
	117	T28	

11 SETEMBRO 2022		Pág: 021	
	1.76	V 42	
		V 39	
		V 36	00.34.27
	118	T28	
	1.83	V 42	
		V 39	
		V 36	00.34.34
	119	T28	
	2.07	V 42	
		V 39	
		V 36	00.34.58
	120	T28	
	2.15	V 42	
		V 39	
		V 36	00.35.06
	121	T28	
	2.21	V 42	
		V 39	
		V 36	00.35.12
	122	T28	
	2.28	V 42	
		V 39	
		V 36	00.35.19
	123	T28	

CUIDADO+

	2.41	
	V 61	00.34.50
	V 54	00.35.03
	V 51	00.35.32
124	T29	

	2.83	
	V 61	
	V 54	
	V 51	00.36.01
125	T29	

SOBE

	3.21	
	V 47	00.35.38
	V 44	00.35.57
	V 41	00.36.28
126	T30	

CUIDADO

	3.81	
	V 42	00.36.24
	V 39	00.36.46
	V 36	00.37.21
127	T31	

	3.88	
	V 42	
	V 39	
	V 36	00.37.28
128	T31	

	4.09	
	V 42	
	V 39	
	V 36	00.37.49
129	T31	

	4.24	
	V 47	00.37.00
	V 44	00.37.25
	V 41	00.38.04
130	T32	

DESCE

	4.37	
	V 47	
	V 44	
	V 41	00.38.15
131	T32	

DESCE

	4.42	
	V 47	
	V 44	
	V 41	00.38.20
132	T32	

CUIDADO MOTOS

	4.63	
	V 61	00.37.30
	V 54	00.37.57
	V 51	00.38.38
133	T33	

	4.75	
	V 61	
	V 54	
	V 51	00.38.47
134	T33	

	4.84	
	V 61	
	V 54	
	V 51	00.38.53
135	T33	

	5.27	
	V 61	
	V 54	
	V 51	00.39.23
136	T33	

SOBE

	5.64	
	V 47	00.38.30
	V 44	00.39.05
	V 41	00.39.49
137	T34	

CUIDADO

	6.24	
	V 41	00.39.16
	V 39	00.39.54
	V 36	00.40.42
138	T35	

	6.31	
	V 41	
	V 39	
	V 36	00.40.49
139	T35	

	6.52	
	V 41	
	V 39	
	V 36	00.41.10
140	T35	





DIREÇÃO A PALMEIRA





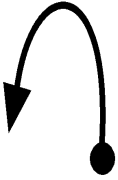

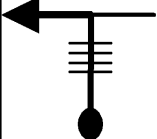
	6.67	
	V 37	00.39.54
	V 35	00.40.33
	V 33	00.41.25
141	T36	





	6.88	
	V 37	
	V 35	
	V 33	00.41.48
	142	T36
PEDRA		
	6.95	
	V 37	
	V 35	
	V 33	00.41.56
	143	T36
	6.98	
	V 37	
	V 35	
	V 33	00.41.59
	144	T36
	7.00	
	N 5'	00.40.26
	N 4'	00.41.07
	N 4'	00.42.01
	145	T37
	7.00	
	V 39	00.45.26
	V 36	00.45.07
	V 33	00.46.01
	146	T38
	7.25	
	V 39	
	V 36	
	V 33	00.46.28
	147	T38
	7.28	
	V 39	
	V 36	
	V 33	00.46.32
	148	T38





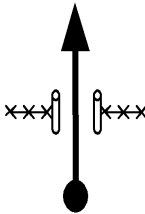

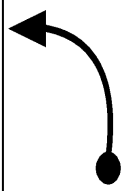

NÃO ERRE		
	8.02	
	V 49	00.47.00
	V 45	00.46.49
	V 42	00.47.52
	149	T39
	8.07	
	V 49	
	V 45	
	V 42	00.47.57
	150	T39
	8.42	
	V 49	
	V 45	
	V 42	00.48.27
	151	T39
	8.81	
	V 49	
	V 45	
	V 42	00.49.00
	152	T39
	8.92	
	V 49	
	V 45	
	V 42	00.49.09
	153	T39
	9.63	
	V 49	
	V 45	
	V 42	00.50.10
	154	T39

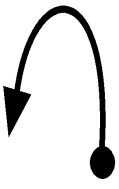

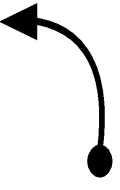

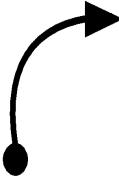
	9.74	
	V 42	00.49.06
	V 39	00.49.07
	V 36	00.50.20
	155	T40
	9.99	
	V 42	
	V 39	
	V 36	00.50.45
	156	T40
	10.05	
	V 42	
	V 39	
	V 36	00.50.51
	157	T40
	10.24	
	N 3'	00.49.49
	N 2'30"	00.49.53
	N 2'	00.51.10
	158	T41
	10.24	
	0.00	
	V 36	00.52.49
	V 36	00.52.23
	V 36	00.53.10
159	T42	
	0.17	
	V 36	
	V 36	
	V 36	00.53.27
	160	T42



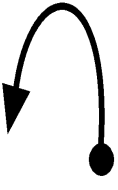

	0.43	
	V 36	
	V 36	
	V 36	00.53.53
	161	T42
CUIDADO		
	0.78	
	V 36	
	V 36	
	V 36	00.54.28
	162	T42
	1.13	
	N30s	00.54.42
	N30s	00.54.16
	N30s	00.55.03
	163	T43
PPL		
CUIDADO ESTRADA		
MOVIMENTADA		
	1.13	
	V 39	00.55.12
	V 39	00.54.46
	V 39	00.55.33
	164	T44
PPL		
	1.57	
	V 39	
	V 39	
	V 39	00.56.13
	165	T44
PPL		
	2.37	
	V 39	
	V 39	
	V 39	00.57.27
	166	T44

PPL		
	2.98	
	V 39	
	V 39	
	V 39	00.58.23
	167	T44
PPL		
	3.25	
	V 39	
	V 39	
	V 39	00.58.48
	168	T44
	3.53	
	V 39	
	V 39	
	V 39	00.59.14
	169	T44
SAI DA PRINCIPAL		
NÃO ERRE		
	3.69	
	0.00	
	V 41	00.59.08
	V 37	00.58.42
	V 33	00.59.29
170	T45	
	0.03	
	V 41	
	V 37	
	V 33	00.59.32
	171	T45
	0.11	
	V 41	
	V 37	
	V 33	00.59.41
	172	T45

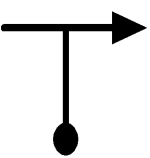
TELHAS		
	0.19	
	V 41	00.59.25
	V 38	00.59.01
	V 35	00.59.50
	173	T46
	0.31	
	V 41	
	V 38	
	V 35	01.00.02
	174	T46
	0.68	
	V 41	
	V 38	
	V 35	01.00.40
	175	T46
ACELERA		
SOBE		
	1.09	
	V 33	01.00.44
	V 30	01.00.26
	V 27	01.01.22
	176	T47
ACELERA		
SOBE		
	1.52	
	V 33	
	V 30	
	V 27	01.02.20
	177	T47
	1.71	
	V 33	
	V 30	
	V 27	01.02.45
	178	T47

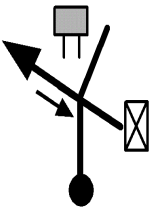
11 SETEMBRO 2022		Pág: 031	
	1.81	V 33	
		V 30	
		V 27	01.02.58
	179	T47	
			
	1.92	V 33	
		V 30	
		V 27	01.03.13
	180	T47	
CUIDADO			
			
	2.24	V 33	
		V 30	
		V 27	01.03.56
	181	T47	
DESCE			
PERIGO			
	2.36	V 22	01.03.03
		V 20	01.02.58
		V 18	01.04.12
	182	T48	
PERIGO			
			
	2.61	V 22	
		V 20	
		V 18	01.05.02
	183	T48	

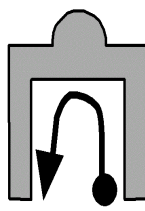
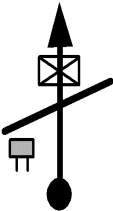





11 SETEMBRO 2022		Pág: 032	
	2.82	V 22	
		V 20	
		V 18	01.05.44
	184	T48	
	2.90	V 31	01.04.31
		V 27	01.04.36
		V 24	01.06.00
	185	T49	
	3.21	V 39	01.05.07
		V 36	01.05.17
		V 33	01.06.46
	186	T50	
BAMBU			
	3.55	V 39	
		V 36	
		V 33	01.07.23
	187	T50	
	3.60	N 3'	01.05.43
		N 3'	01.05.56
		N 3'	01.07.29
	188	T51	
PPL			
CUIDADO MOVIMENTADA			
	3.60	V 39	01.08.43
		V 39	01.08.56
		V 39	01.10.29
	189	T52	





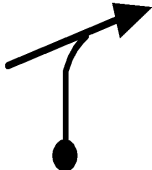

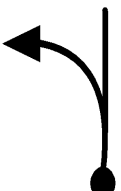
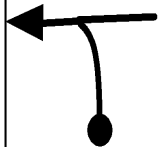
11 SETEMBRO 2022		Pág: 033	
	4.28	V 39	
		V 39	
		V 39	01.11.31
	190	T52	
NEUTRO PRINCIPAL			
	4.35	N 20'	01.09.52
		N 20'	01.10.05
		N 20'	01.11.38
	191	T53	
RETORNE			
ZERE NO PORTAL			
KMACUMULADO 34,83			
	4.35		
	0.00	V 27	01.29.52
		V 27	01.30.05
		V 27	01.31.38
	192	T54	
SOBE			
	0.04	V 41	01.29.58
		V 37	01.30.11
		V 34	01.31.43
	193	T55	
PEDRAS SOBE			
	0.16	V 41	
		V 37	
		V 34	01.31.56
	194	T55	



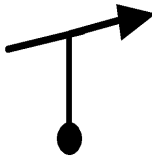

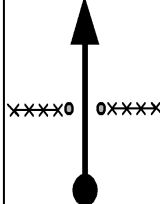

	0.44
	V 41
	V 37
	V 34 01.32.26
	195 T55
	0.49
	V 41
	V 37
	V 34 01.32.31
	196 T55
	0.73
	V 41
	V 37
	V 34 01.32.56
	197 T55
	0.91
	V 41
	V 37
	V 34 01.33.15
	198 T55
PELA ESQUERDA	
	1.03
	V 41
	V 37
	V 34 01.33.28
	199 T55
	1.19
	V 41
	V 37
	V 34 01.33.45
	200 T55
	1.59
	V 41
	V 37
	V 34 01.34.27
	201 T55





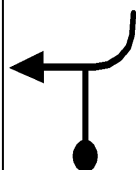
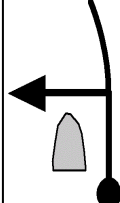

	1.97
	V 40 01.32.47
	V 37 01.33.18
	V 33 01.35.08
	202 T56
	2.37
	V 40
	V 37
	V 33 01.35.51
	203 T56
	2.81
	V 40
	V 37
	V 33 01.36.39
	204 T56
	2.97
	V 19 01.34.17
	V 17 01.34.56
	V 15 01.36.57
	205 T57
	2.99
	V 37 01.34.21
	V 33 01.35.00
	V 30 01.37.01
	206 T58
	3.11
	V 40 01.34.32
	V 37 01.35.13
	V 33 01.37.16
	207 T59
	3.39
	V 37 01.34.58
	V 33 01.35.40
	V 30 01.37.46
	208 T60





	3.77
	V 40 01.35.35
	V 36 01.36.22
	V 33 01.38.32
	209 T61
DESCE	
	3.92
	V 40
	V 36
	V 33 01.38.48
	210 T61
	3.95
	V 40
	V 36
	V 33 01.38.52
	211 T61
	4.00
	N 3' 01.35.55
	N 2' 01.36.45
	N 2' 01.38.57
	212 T62
	4.00
	V 40 01.38.55
	V 36 01.38.45
	V 33 01.40.57
	213 T63
	4.08
	V 42 01.39.03
	V 39 01.38.53
	V 37 01.41.06
	214 T64
	4.11
	V 42
	V 39
	V 37 01.41.09
	215 T64



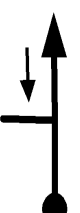

11 SETEMBRO 2022		Pág: 037	
	4.15	V 41	01.39.09
		V 38	01.38.59
		V 36	01.41.13
		216	T65
	4.32	V 41	
		V 38	
		V 36	01.41.30
		217	T65
	4.46	V 41	
		V 38	
		V 36	01.41.44
		218	T65
	4.50	V 41	
		V 38	
		V 36	01.41.48
		219	T65
	4.72	V 41	
		V 38	
		V 36	01.42.10
		220	T65
	4.91	V 41	
		V 38	
		V 36	01.42.29
		221	T65
	4.94	V 41	
		V 38	
		V 36	01.42.32
		222	T65

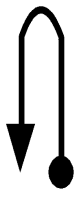
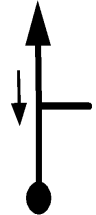



11 SETEMBRO 2022		Pág: 038	
	5.03	V 41	
		V 38	
		V 36	01.42.41
		223	T65
	5.18	V 41	
		V 38	
		V 36	01.42.56
		224	T65
	5.29	V 48	01.40.49
		V 45	01.40.47
		V 42	01.43.07
		225	T66
	5.31	V 48	
		V 45	
		V 42	01.43.08
		226	T66
	5.53	V 48	
		V 45	
		V 42	01.43.27
		227	T66
	5.66	V 48	
		V 45	
		V 42	01.43.38
		228	T66
CUIDADO MOTOS			
	5.76	V 48	
		V 45	
		V 42	01.43.47
		229	T66



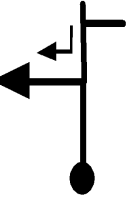

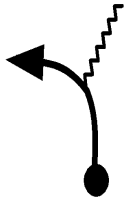
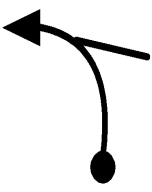
11 SETEMBRO 2022		Pág: 039	
	5.92	V 48	
		V 45	
		V 42	01.44.01
		230	T66
	6.02	V 48	
		V 45	
		V 42	01.44.09
		231	T66
	6.05	V 48	
		V 45	
		V 42	01.44.12
		232	T66
	6.28	V 48	
		V 45	
		V 42	01.44.31
		233	T66
	6.60	V 48	
		V 45	
		V 42	01.44.59
		234	T66
	6.85	V 48	
		V 45	
		V 42	01.45.20
		235	T66
CUIDADO MOTOS			
	6.98	V 48	
		V 45	
		V 42	01.45.31
		236	T66



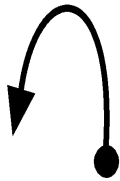

11 SETEMBRO 2022		Pág: 040	
	7.15		
	V 48		
	V 45		
	V 42	01.45.46	
	237	T66	
	7.26		
	V 48		
	V 45		
	V 42	01.45.55	
	238	T66	
	7.29		
	V 48		
	V 45		
	V 42	01.45.58	
	239	T66	
			
	7.45		
	V 15	01.43.31	
	V 15	01.43.40	
	V 15	01.46.12	
	240	T67	
CUIDADO			
MSC			
	7.49		
	N 2'	01.43.40	
	N 1'	01.43.49	
	N30s	01.46.21	
	241	T68	

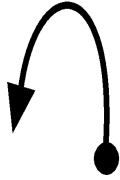
11 SETEMBRO 2022		Pág: 041	
MSC			
	7.49		
	V 15	01.45.40	
	V 15	01.44.49	
	V 15	01.46.51	
	242	T69	
MSC			
	7.66		
	V 15		
	V 15		
	V 15	01.47.32	
	243	T69	
VISUAL PALHOÇA			
KM ACUMULADO 42,54			
	7.71		
	N 5'	01.46.33	
	N 5'	01.45.42	
	N 4'	01.47.44	
	244	T70	
	7.71		
	V 15	01.51.33	
	V 15	01.50.42	
	V 15	01.51.44	
	245	T71	
ZERA BUMP			
	7.74		
	0.00		
	V 15	01.51.40	
	V 15	01.50.49	
	V 15	01.51.51	
246	T72		
	0.18		
	V 42	01.52.23	
	V 39	01.51.33	
	V 35	01.52.35	
	247	T73	

11 SETEMBRO 2022		Pág: 042	
	0.47		
	V 42		
	V 39		
	V 35	01.53.04	
	248	T73	
ATENÇÃO			
	0.76		
	V 39	01.53.13	
	V 36	01.52.26	
	V 33	01.53.34	
	249	T74	
	0.78		
	V 39		
	V 36		
	V 33	01.53.36	
	250	T74	
	0.97		
	V 39		
	V 36		
	V 33	01.53.57	
	251	T74	
SOBE EROSIÃO			
	1.19		
	V 39		
	V 36		
	V 33	01.54.21	
	252	T74	
	1.42		
	V 39		
	V 36		
	V 33	01.54.46	
	253	T74	

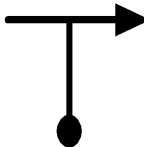
11 SETEMBRO 2022		Pág: 043	
	1.80	V 36	01.54.49
		V 33	01.54.10
		V 30	01.55.28
	254	T75	
	2.25	V 36	
		V 33	
		V 30	01.56.22
	255	T75	
	2.40	V 30	01.55.49
		V 27	01.55.16
		V 24	01.56.40
	256	T76	
SOBE			
	2.76	V 30	
		V 27	
		V 24	01.57.34
	257	T76	
	2.84	V 30	
		V 27	
		V 24	01.57.46
	258	T76	
DESCE FORTE			
	2.94	V 27	01.56.54
		V 24	01.56.28
		V 21	01.58.01
	259	T77	

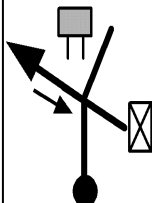
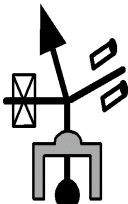
11 SETEMBRO 2022		Pág: 044	
PERIGO			
	3.00	V 22	01.57.02
		V 20	01.56.37
		V 18	01.58.11
	260	T78	
	3.26	V 22	
		V 20	
		V 18	01.59.03
	261	T78	
	3.46	V 22	
		V 20	
		V 18	01.59.43
	262	T78	
	3.54	V 31	01.58.30
		V 27	01.58.14
		V 24	01.59.59
	263	T79	
	3.85	V 39	01.59.06
		V 36	01.58.55
		V 33	02.00.45
	264	T80	
BAMBU			
	4.18	V 39	
		V 36	
		V 33	02.01.21
	265	T80	

11 SETEMBRO 2022		Pág: 045	
PPL			
CUIDADO MOVIMENTADA			
	4.25	N 4'	01.59.43
		N3'30s	01.59.35
		N 3'	02.01.29
	266	T81	
	4.25	V 39	02.03.43
		V 39	02.03.05
		V 39	02.04.29
	267	T82	
CUIDADO			
 	4.93	V 27	02.04.46
		V 27	02.04.08
		V 27	02.05.32
	268	T83	
	5.00	V 27	
		V 27	
		V 27	02.05.41
	269	T83	
NÃO ERRE			
	5.06	V 27	
		V 27	
		V 27	02.05.49
	270	T83	
DESCE			
	5.09	V 37	02.05.07
		V 35	02.04.29
		V 33	02.05.53
	271	T84	

11 SETEMBRO 2022		Pág: 046	
CUIDADO AO ATRAVESSAR			
	5.19		
	V 37		
	V 35		
	V 33	02.06.04	
	272	T84	
	5.36		
	V 37		
	V 35		
	V 33	02.06.23	
	273	T84	
	5.47		
	V 37		
	V 35		
	V 33	02.06.35	
	274	T84	
	5.55		
	V 37		
	V 35		
	V 33	02.06.43	
	275	T84	
	5.64		
	V 37		
	V 35		
	V 33	02.06.53	
	276	T84	
	5.73		
	V 37		
	V 35		
	V 33	02.07.03	
	277	T84	
	5.76		
	V 37		
	V 35		
	V 33	02.07.06	
	278	T84	

11 SETEMBRO 2022		Pág: 047	
ENTRE MATO			
	5.86		
	V 37		
	V 35		
	V 33	02.07.17	
	279	T84	
	6.09		
	V 37		
	V 35		
	V 33	02.07.42	
	280	T84	
NÃO ERRE			
	6.84		
	V 37		
	V 35		
	V 33	02.09.04	
	281	T84	
DESCE			
	6.92		
	V 42	02.08.05	
	V 39	02.07.37	
	V 36	02.09.13	
	282	T85	
	7.04		
	V 42		
	V 39		
	V 36	02.09.25	
	283	T85	
	7.18		
	V 42		
	V 39		
	V 36	02.09.39	
	284	T85	

11 SETEMBRO 2022		Pág: 048	
SAI DO MATO			
	7.32		
	V 42		
	V 39		
	V 36	02.09.53	
	285	T85	
	7.35		
	N 2'	02.08.42	
	N 2'	02.08.17	
	N 2'	02.09.56	
	286	T86	
PPL			
CUIDADO MOVIMENTADA			
	7.35		
	V 39	02.10.42	
	V 39	02.10.17	
	V 39	02.11.56	
	287	T87	
PPL			
	8.16		
	V 39		
	V 39		
	V 39	02.13.11	
	288	T87	
PPL			
	9.01		
	V 39		
	V 39		
	V 39	02.14.29	
	289	T87	
PPL			
	9.46		
	V 39		
	V 39		
	V 39	02.15.11	
	290	T87	

11 SETEMBRO 2022		Pág: 049	
	10.52	V 39	
		V 39	
		V 39	02.16.48
	291	T87	
PPL			
	10.62	V 39	
		V 39	
		V 39	02.16.58
	292	T87	
CUIDADO CASAS			
	12.03	0.00	
		V 27	02.17.54
		V 27	02.17.29
		V 27	02.19.08
293	T88		
	0.17	V 27	
		V 27	
		V 27	02.19.30
	294	T88	
	0.21	V 33	02.18.22
		V 30	02.17.57
		V 27	02.19.36
	295	T89	
	0.31	V 33	
		V 30	
		V 27	02.19.49
	296	T89	

11 SETEMBRO 2022		Pág: 050	
	0.34	N 1'	02.18.36
		N 1'	02.18.13
		N 1'	02.19.53
	297	T90	
PISTA DO JÃO			
ENTRE COM CUIDADO			
MOTOS EM VELOCIDADE			
	0.34	V 49	02.19.36
		V 45	02.19.13
		V 42	02.20.53
	298	T91	
SALTO			
	0.44	V 49	
		V 45	
		V 42	02.21.02
	299	T91	
	0.62	V 49	
		V 45	
		V 42	02.21.17
	300	T91	
	0.96	V 49	
		V 45	
		V 42	02.21.46
	301	T91	

11 SETEMBRO 2022		Pág: 051	
SALTO			
	1.08	V 49	
		V 45	
		V 42	02.21.57
	302	T91	
SALTO			
	1.63	V 49	
		V 45	
		V 42	02.22.44
	303	T91	
CUIDADO			
MOTOS ENTRANDO			
	1.90	V 49	
		V 45	
		V 42	02.23.07
	304	T91	
ESCONDIDA			
CUIDADO AO DIMINUIR A VELOCIDADE			
	2.53	V 26	02.22.17
		V 24	02.22.08
		V 22	02.24.01
	305	T92	
	2.56	V 26	
		V 24	
		V 22	02.24.06
	306	T92	

11 SETEMBRO 2022		Pág: 052	
	2.58	V 26	
		V 24	
		V 22	02.24.09
	307	T92	
	2.72	N 3'	02.22.44
		N 3'	02.22.36
		N 3'	02.24.32
	308	T93	
BEM VINDO			
TRILHA DA TORRE			
	2.72	V 31	02.25.44
		V 29	02.25.36
		V 27	02.27.32
	309	T94	
PEDRAS			
	2.84	V 34	02.25.57
		V 31	02.25.51
		V 29	02.27.48
	310	T95	
	3.26	V 34	
		V 31	
		V 29	02.28.40
	311	T95	
	3.83	V 39	02.27.42
		V 36	02.27.46
		V 33	02.29.51
	312	T96	

11 SETEMBRO 2022		Pág: 053	
	4.04	V 39	
		V 36	
		V 33	02.30.14
	313	T96	
	4.54	V 33	02.28.48
		V 30	02.28.57
		V 27	02.31.08
	314	T97	
PELA DIREITA			
	4.84	V 33	
		V 30	
		V 27	02.31.48
	315	T97	
ATOLA			
	4.91	V 21	02.29.28
		V 19	02.29.42
		V 17	02.31.58
	316	T98	
EROSÃO DESCE			
	5.06	V 17	02.29.54
		V 16	02.30.10
		V 15	02.32.29
	317	T99	
	5.09	V 17	
		V 16	
		V 15	02.32.37
	318	T99	

11 SETEMBRO 2022		Pág: 054	
ATOLA			
	5.18	V 17	
		V 16	
		V 15	02.32.58
	319	T99	
	5.26	V 33	02.30.36
		V 30	02.30.55
		V 27	02.33.17
	320	T100	
CUIDADO MOTOS			
	5.33	V 33	
		V 30	
		V 27	02.33.27
	321	T100	
	5.42	V 33	
		V 30	
		V 27	02.33.39
	322	T100	
	5.90	V 39	02.31.46
		V 36	02.32.12
		V 33	02.34.43
	323	T101	
	6.05	N 5'	02.32.00
		N 4'	02.32.27
		N 3'	02.34.59
	324	T102	

11 SETEMBRO 2022		Pág: 055	
NÃO ERRE			
OVER55 PULA PARA			
REFERENCIA 2,52 TR119			
	6.05		
	V 39	02.37.00	
	V 36	02.36.27	
	V 33	02.37.59	
	325	T103	
CUIDADO MOTOS			
	6.20		
	V 39		
	V 36		
	V 33	02.38.15	
	326	T103	
SALTO			
	6.25		
	V 39		
	V 36		
	V 33	02.38.21	
	327	T103	
	6.32		
	V 39		
	V 36		
	V 33	02.38.28	
	328	T103	
	6.34		
	V 39		
	V 36		
	V 33	02.38.31	
	329	T103	
	6.49		
	V 39		
	V 36		
	V 33	02.38.47	
	330	T103	

11 SETEMBRO 2022		Pág: 056	
ESCONDIDA			
TRILHA DA GARGANDA			
DESCE FORTE			
	6.52		
	V 17	02.37.43	
	V 16	02.37.14	
	V 15	02.38.50	
	331	T104	
PEDRAS			
	6.71		
	V 33	02.38.24	
	V 30	02.37.57	
	V 27	02.39.36	
	332	T105	
	7.12		
	V 36	02.39.08	
	V 33	02.38.46	
	V 30	02.40.31	
	333	T106	
CURVA PERIGOSA			
	7.44		
	V 36		
	V 33		
	V 30	02.41.09	
	334	T106	
	7.59		
	V 36		
	V 33		
	V 30	02.41.27	
	335	T106	
	7.75		
	N 2'	02.40.11	
	N 2'	02.39.55	
	N1'30s	02.41.46	
	336	T107	

11 SETEMBRO 2022		Pág: 057	
	7.75		
	0.00		
	V 33	02.42.11	
	V 30	02.41.55	
	V 27	02.43.16	
337	T108		
SAIA DO TRILHO			
PELO BARRANCO			
A DIREITA			
	0.16		
	V 33		
	V 30		
	V 27	02.43.38	
	338	T108	
EVITE O TRILHO			
DO JEEP			
	0.19		
	V 33		
	V 30		
	V 27	02.43.42	
	339	T108	
	0.24		
	V 33		
	V 30		
	V 27	02.43.48	
	340	T108	
	0.28		
	V 33		
	V 30		
	V 27	02.43.54	
	341	T108	
	0.74		
	V 33		
	V 30		
	V 27	02.44.55	
	342	T108	

11 SETEMBRO 2022		Pág: 058	
	1.10		
	V 33		
	V 30		
	V 27	02.45.43	
	343	T108	
	1.15		
	V 39	02.44.17	
	V 36	02.44.13	
	V 33	02.45.50	
	344	T109	
	2.03		
	V 39		
	V 36		
	V 33	02.47.26	
	345	T109	
	2.48		
	V 33	02.46.19	
	V 30	02.46.26	
	V 27	02.48.15	
	346	T110	
	2.76		
	V 33		
	V 30		
	V 27	02.48.52	
	347	T110	
	3.42		
	V 33		
	V 30		
	V 27	02.50.20	
	348	T110	
	3.53		
	V 33		
	V 30		
	V 27	02.50.35	
	349	T110	

11 SETEMBRO 2022		Pág: 059	
	3.57		
	V 33		
	V 30		
	V 27	02.50.40	
	350	T110	
	3.96		
	N 5'	02.49.01	
	N 4'30"	02.49.23	
	N 4'	02.51.32	
	351	T111	
	3.96		
	V 36	02.54.01	
	V 33	02.53.53	
	V 30	02.55.32	
	352	T112	
	4.41		
	V 36		
	V 33		
	V 30	02.56.26	
	353	T112	
	4.78		
	V 36		
	V 33		
	V 30	02.57.10	
	354	T112	
	4.83		
	0.00		
	V 33	02.55.28	
	V 30	02.55.28	
	V 27	02.57.16	
355	T113		

11 SETEMBRO 2022		Pág: 060	
	0.18		
	V 33		
	V 30		
	V 27	02.57.40	
	356	T113	
	0.21		
	V 33		
	V 30		
	V 27	02.57.44	
	357	T113	
DESCE FORTE			
	0.40		
	V 33		
	V 30		
	V 27	02.58.10	
	358	T113	
CUIDADO			
TRONCOS TIRA FRENTE			
	0.75		
	V 36	02.56.50	
	V 33	02.56.58	
	V 30	02.58.56	
	359	T114	
ARVORE CAÍDA			
DESVIA			
	1.19		
	V 14	02.57.34	
	V 13	02.57.46	
	V 12	02.59.49	
	360	T115	

11 SETEMBRO 2022		Pág: 061	
	1.22	V 29	02.57.41
		V 27	02.57.54
		V 25	02.59.58
	361	T116	
	1.30	V 29	
		V 27	
		V 25	03.00.10
	362	T116	
	1.43	V 29	
		V 27	
		V 25	03.00.28
	363	T116	
PELA DIREITA			
	1.47	V 29	
		V 27	
		V 25	03.00.34
	364	T116	
	1.54	N 4'	02.58.21
		N 3'30"	02.58.37
		N 3'	03.00.44
	365	T117	
CUIDADO MOTOS			
	1.54	V 29	03.02.21
		V 26	03.02.07
		V 24	03.03.44
	366	T118	

11 SETEMBRO 2022		Pág: 062	
	1.62	V 29	
		V 26	
		V 24	03.03.56
	367	T118	
	1.99	V 33	03.03.17
		V 30	03.03.09
		V 27	03.04.52
	368	T119	
	2.02	V 33	
		V 30	
		V 27	03.04.56
	369	T119	
PELA ESQUERDA			
NO BARRANCO			
	2.11	V 33	
		V 30	
		V 27	03.05.08
	370	T119	
	2.37	V 33	
		V 30	
		V 27	03.05.42
	371	T119	
NÃO ERRE			
SOBE			
NÃO PERDE EMBALO			
	2.52	V 22	03.04.15
		V 20	03.04.13
		V 18	03.06.02
	372	T120	

11 SETEMBRO 2022		Pág: 063	
CUIDADO TOCOS			
	2.57	V 22	
		V 20	
		V 18	03.06.12
	373	T120	
CUIDADO MOTOS			
	2.62	V 33	03.04.31
		V 30	03.04.31
		V 27	03.06.22
	374	T121	
SALTO			
	2.66	V 33	
		V 30	
		V 27	03.06.28
	375	T121	
	2.73	V 33	
		V 30	
		V 27	03.06.37
	376	T121	
	2.80	V 33	
		V 30	
		V 27	03.06.46
	377	T121	
RANCHO XERIFE			
	3.05	N 3'	03.05.18
		N 2'30"	03.05.23
		N 2'30"	03.07.20
	378	T122	

11 SETEMBRO 2022		Pág: 064	
	3.05	V 36	03.08.18
		V 33	03.07.53
		V 30	03.09.50
	379	T123	
NÃO SALTE			
	3.38	V 36	
		V 33	
		V 30	03.10.29
	380	T123	
	3.70	V 36	
		V 33	
		V 30	03.11.08
	381	T123	
VALO DEPOIS SOBE			
	3.92	V 36	
		V 33	
		V 30	03.11.34
	382	T123	
ESCONDIDA			
NÃO ERRE			
	4.05	V 14	03.09.58
		V 13	03.09.42
		V 12	03.11.50
	383	T124	
	4.10	V 14	
		V 13	
		V 12	03.12.05
	384	T124	







11 SETEMBRO 2022		Pág: 065	
	4.17	V 14	
		V 13	
		V 12	03.12.26
	385	T124	
	4.19	V 14	
		V 13	
		V 12	03.12.32
	386	T124	
	4.22	N 30s	03.10.42
		N 30s	03.10.29
		N 30s	03.12.41
	387	T125	
ENTRA NA PISTA			
CUIDADO			
	4.22	V 51	03.11.12
		V 47	03.10.59
		V 44	03.13.11
	388	T126	
SALTO			
	4.30	V 51	
		V 47	
		V 44	03.13.17
	389	T126	
DESCE			
	5.04	V 51	
		V 47	
		V 44	03.14.18
	390	T126	



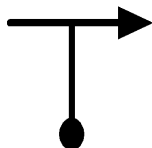

11 SETEMBRO 2022		Pág: 066	
SAI DA PISTA			
MSC			
	5.15	V 21	03.12.17
		V 21	03.12.10
		V 21	03.14.27
	391	T127	
MSC			
	5.30	V 27	03.12.43
		V 27	03.12.36
		V 27	03.14.52
	392	T128	
	5.48	N 30s	03.13.07
		N 30s	03.13.00
		N 30s	03.15.16
	393	T129	
CUIDADO MOVIMENTADA			
PPL			
	5.48	V 39	03.13.37
		V 39	03.13.30
		V 39	03.15.46
	394	T130	
PPL			
	6.91	V 39	
		V 39	
		V 39	03.17.58
	395	T130	
PPL			
	7.00	V 39	
		V 39	
		V 39	03.18.07
	396	T130	



11 SETEMBRO 2022		Pág: 067	
PPL			
	8.05		
	V 39		
	V 39		
	V 39	03.19.44	
	397	T130	
PPL			
	8.50		
	V 39		
	V 39		
	V 39	03.20.25	
	398	T130	
CASAS			
	8.95		
	V 33	03.18.57	
	V 30	03.18.50	
	V 27	03.21.07	
	399	T131	
	9.47		
	V 48	03.19.54	
	V 45	03.19.52	
	V 42	03.22.16	
	400	T132	
	9.64		
	V 48		
	V 45		
	V 42	03.22.31	
	401	T132	
	9.86		
	V 48		
	V 45		
	V 42	03.22.50	
	402	T132	

11 SETEMBRO 2022		Pág: 068	
CUIDADO			
	9.92		
	0.00		
	V 39	03.20.28	
	V 36	03.20.28	
	V 33	03.22.55	
403	T133		
	0.17		
	V 39		
	V 36		
	V 33	03.23.13	
	404	T133	
SOBE			
	0.33		
	V 39		
	V 36		
	V 33	03.23.31	
	405	T133	
	0.36		
	V 39		
	V 36		
	V 33	03.23.34	
	406	T133	
	0.42		
	V 39		
	V 36		
	V 33	03.23.41	
	407	T133	
	0.61		
	N30s	03.21.24	
	N30s	03.21.29	
	N30s	03.24.01	
	408	T134	

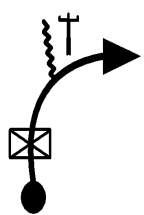
11 SETEMBRO 2022		Pág: 069	
	0.61		
	V 42	03.21.54	
	V 39	03.21.59	
	V 36	03.24.31	
	409	T135	
CUIDADO			
	0.64		
	V 42		
	V 39		
	V 36	03.24.34	
	410	T135	
	0.81		
	V 42		
	V 39		
	V 36	03.24.51	
	411	T135	
	1.06		
	V 42		
	V 39		
	V 36	03.25.16	
	412	T135	
	1.30		
	V 49	03.22.53	
	V 45	03.23.03	
	V 42	03.25.40	
	413	T136	
	1.97		
	V 49		
	V 45		
	V 42	03.26.38	
	414	T136	

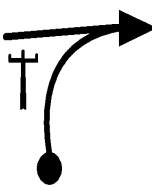
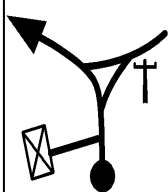
11 SETEMBRO 2022		Pág: 070	
	2.13	V 42	03.23.54
		V 39	03.24.09
		V 36	03.26.51
	415	T137	
	2.52	V 42	
		V 39	
		V 36	03.27.30
	416	T137	
	3.01	V 39	03.25.10
		V 36	03.25.31
		V 33	03.28.19
	417	T138	
CUIDADO			
			
	3.24	V 39	
		V 36	
		V 33	03.28.44
	418	T138	
	3.80	V 39	
		V 36	
		V 33	03.29.46
	419	T138	
			

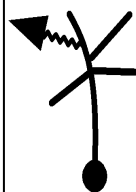
11 SETEMBRO 2022		Pág: 071	
	3.98	V 39	
		V 36	
		V 33	03.30.05
	420	T138	
	4.03	N 2'	03.26.44
		N 2'	03.27.13
		N 2'	03.30.11
	421	T139	
CUIDADO CASAS			
	4.03	V 33	03.28.44
		V 30	03.29.13
		V 27	03.32.11
	422	T140	
	4.20	V 33	
		V 30	
		V 27	03.32.33
	423	T140	
CASAS			
	4.25	V 33	03.29.08
		V 33	03.29.39
		V 33	03.32.40
	424	T141	
	4.55	V 36	03.29.41
		V 36	03.30.12
		V 36	03.33.13
	425	T142	

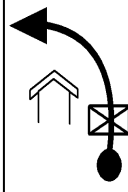
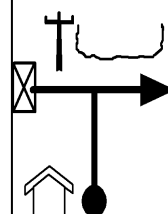
11 SETEMBRO 2022		Pág: 072	
	4.86	V 36	
		V 36	
		V 36	03.33.44
	426	T142	
SOBE			
	4.94	V 36	03.30.20
		V 33	03.30.51
		V 30	03.33.52
	427	T143	
SALTO NÃO EXAGERAR			
	5.06	V 36	
		V 33	
		V 30	03.34.06
	428	T143	
FIM			
ENTREGUE GPS			
KM ACUMULADO 82,18			
	5.08	V 36	
		V 33	
		V 30	03.34.08
	429	T143	
OPCIONAL			
SUBIDA DESAFIO			
	5.08	D 2'	03.30.34
		D 2'	03.31.06
		D 2'	03.34.08
	430	T144	
SOBE			
	5.15		
	431	T144	

	5.18
432	T144

	5.24
433	T144

	5.29
434	T144

	5.37
435	T144

ACREDITA

SOBE

	5.41
436	T144

GANGORRA

	5.47
437	T144

	5.47	
	N 1s	03.32.34
	N 1s	03.33.06
	N 1s	03.36.08
438	T145	

FIM DE PROVA !!



www.t15.com.br

Tempo de Prova

MÉDIA A 03:32:34

MÉDIA B 03:33:06

MÉDIA C 03:36:08

FIM