

INICIO**MÉDIA A****MÉDIA B****MÉDIA C**II ENDURO DO CABRITO
24/11/2018**IMPORTANTE**DIRETOR DE PROVA:
CABRITONOS TRECHOS URBANOS
PREVALECEM AS LEIS DO
CODIGO NACIONAL DE
TRANSITO.É OBRIGATORIO RESPEITAR
AS PROPRIEDADES ALHEIAS
E OS MORADORES.A ORGANIZAÇÃO NAO SE
RESPONSABILIZA POR
PASSAR A PROGRAMAÇÃO DE
NAVEGAÇÃO.CONFERIR SEQUENCIAS
NUMERICAS DAS TULIPAS.ONDE NAO A REFERENCIA
MANTENHA SE NA
PRINCIPAL.LEVANTAMENTO DA PROVA
COM MOTO KTM COM PNEU
DIANTEIRO NOVO 12
LIBRAS.E UMA BOA SORTE A
TODOSSSSSSS!!!!

	CUIDADO
	ATENÇÃO
	MUITA ATENÇÃO

Tempo de Prova

MÉDIA A 03:44:05

MÉDIA B 03:48:20

MÉDIA C 03:51:13

**AFERIÇÃO**

	0.00		
		1	AFER
	0.03		
		2	AFER
	0.15		
		3	AFER
	0.47		
		4	AFER
	0.67		
		5	AFER

	0.86		
		6	AFER
	1.15		
		7	AFER
	1.86		
	0.00		
		8	AFER
INICIO DE PROVA			
	0.00		
		V 27	00.00.00
		V 27	00.00.00
		V 27	00.00.00
		9	T1
	0.03		
		V 27	
		V 27	
		V 27	00.00.04
		10	T1

24/11/2018		Pág: 004	
	0.15	V 27	
		V 27	
		V 27	00.00.20
	11	T1	
	0.47	V 27	
		V 27	
		V 27	00.01.03
	12	T1	
	0.67	V 27	
		V 27	
		V 27	00.01.29
	13	T1	
	0.86	V 39	00.01.55
		V 36	00.01.55
		V 33	00.01.55
	14	T2	
	0.94	V 39	
		V 36	
		V 33	00.02.03
	15	T2	
	1.00	V 39	
		V 36	
		V 33	00.02.10
	16	T2	
	1.23	V 39	
		V 36	
		V 33	00.02.35
	17	T2	





24/11/2018		Pág: 005	
	1.35	V 39	
		V 36	
		V 33	00.02.48
	18	T2	
	1.46	V 39	
		V 36	
		V 33	00.03.00
	19	T2	
	1.63	V 39	
		V 36	
		V 33	00.03.19
	20	T2	
	1.81	V 39	
		V 36	
		V 33	00.03.38
	21	T2	
	1.83	V 39	
		V 36	
		V 33	00.03.40
	22	T2	
	2.04	V 39	
		V 36	
		V 33	00.04.03
	23	T2	
	2.07	V 39	
		V 36	
		V 33	00.04.07
	24	T2	



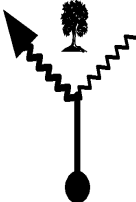
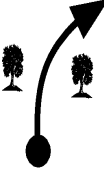
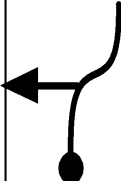
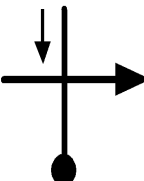

24/11/2018		Pág: 006	
	2.27	V 39	
		V 36	
		V 33	00.04.28
	25	T2	
	2.29	V 39	
		V 36	
		V 33	00.04.31
	26	T2	
	2.31	V 39	
		V 36	
		V 33	00.04.33
	27	T2	
	2.51	V 39	
		V 36	
		V 33	00.04.55
	28	T2	
☠☠☠			
	2.60	V 39	
		V 36	
		V 33	00.05.04
	29	T2	
	2.70	V 42	00.04.44
		V 39	00.04.59
		V 36	00.05.15
	30	T3	
	2.81	V 42	
		V 39	
		V 36	00.05.26
	31	T3	



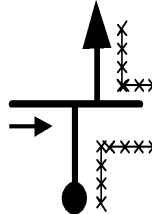

24/11/2018		Pág: 007	
	3.03		
	V 42		
	V 39		
	V 36	00.05.48	
	32	T3	
	3.22		
	V 42		
	V 39		
	V 36	00.06.07	
	33	T3	
	3.41		
	V 42		
	V 39		
	V 36	00.06.26	
	34	T3	
	3.56		
	V 42		
	V 39		
	V 36	00.06.41	
	35	T3	
	3.66		
	V 42		
	V 39		
	V 36	00.06.51	
	36	T3	
	3.85		
	N 1'	00.06.23	
	N 1'	00.06.45	
	N 1'	00.07.10	
	37	T4	
	3.85		
	V 42	00.07.23	
	V 39	00.07.45	
	V 36	00.08.10	
	38	T5	

24/11/2018		Pág: 008	
	3.96		
	V 45	00.07.32	
	V 42	00.07.55	
	V 39	00.08.21	
	39	T6	
	4.03		
	V 45		
	V 42		
	V 39	00.08.28	
	40	T6	
MAR			
	4.12		
	V 45		
	V 42		
	V 39	00.08.36	
	41	T6	
	4.22		
	V 42	00.07.53	
	V 39	00.08.17	
	V 36	00.08.45	
	42	T7	
	4.30		
	V 42		
	V 39		
	V 36	00.08.53	
	43	T7	
	4.43		
	V 45	00.08.11	
	V 42	00.08.37	
	V 39	00.09.06	
	44	T8	
MAR			
	4.51		
	V 45		
	V 42		
	V 39	00.09.14	
	45	T8	

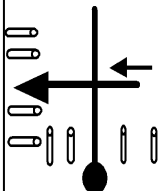
24/11/2018		Pág: 009	
	4.62		
	V 45		
	V 42		
	V 39	00.09.24	
	46	T8	
	5.03		
	V 45		
	V 42		
	V 39	00.10.02	
	47	T8	
	5.31		
	V 45		
	V 42		
	V 39	00.10.28	
	48	T8	
	5.99		
	V 39	00.10.16	
	V 36	00.10.50	
	V 33	00.11.30	
	49	T9	
	6.09		
	V 39		
	V 36		
	V 33	00.11.41	
	50	T9	
	6.17		
	V 39		
	V 36		
	V 33	00.11.50	
	51	T9	
	6.21		
	V 39		
	V 36		
	V 33	00.11.54	
	52	T9	

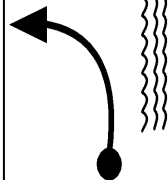
24/11/2018		Pág: 010		
	6.22			
	V 39			
	V 36			
	V 33	00.11.55		
	53	T9		
	6.25			
	V 39			
	V 36			
	V 33	00.11.59		
	54	T9		
	6.31			
	V 39			
	V 36			
	V 33	00.12.05		
	55	T9		
	6.34			
	V 42	00.10.48		
	V 39	00.11.25		
	V 36	00.12.09		
	56	T10		
	6.40			
	V 42			
	V 39			
	V 36	00.12.15		
	57	T10		
	6.89			
	V 42			
	V 39			
	V 36	00.13.04		
	58	T10		
MUITA ATENÇÃO				
				
	7.03			
	N 2'	00.11.48		
	N 2'	00.12.29		
	N 2'	00.13.18		
	59	T11		

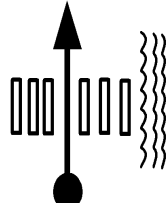
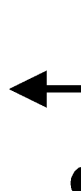
24/11/2018		Pág: 011		
				
	7.03			
	V 42	00.13.48		
	V 39	00.14.29		
	V 36	00.15.18		
	60	T12		
	7.09			
	V 42			
	V 39			
	V 36	00.15.24		
	61	T12		
	7.30			
	V 42			
	V 39			
	V 36	00.15.45		
	62	T12		
	7.66			
	V 42			
	V 39			
	V 36	00.16.21		
	63	T12		
	7.68			
	V 42			
	V 39			
	V 36	00.16.23		
	64	T12		
	7.85			
	V 45	00.14.58		
	V 42	00.15.45		
	V 39	00.16.40		
	65	T13		

24/11/2018		Pág: 012		
	7.92			
	V 45			
	V 42			
	V 39	00.16.46		
	66	T13		
	8.00			
	V 45			
	V 42			
	V 39	00.16.53		
	67	T13		
	8.10			
	V 45			
	V 42			
	V 39	00.17.03		
	68	T13		
	8.51			
	V 45			
	V 42			
	V 39	00.17.40		
	69	T13		
	8.80			
	V 45			
	V 42			
	V 39	00.18.07		
	70	T13		
MUITA ATENÇÃO				
				
	8.96			
	N 2'	00.16.27		
	N 2'	00.17.20		
	N 2'	00.18.22		
	71	T14		

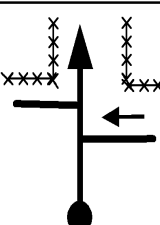
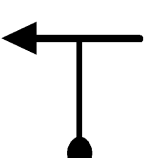
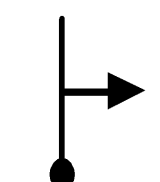
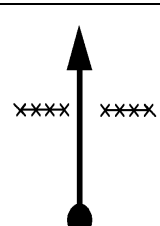
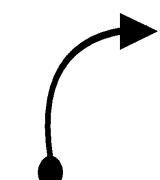
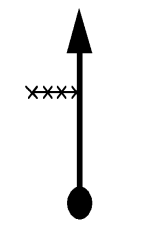
24/11/2018		Pág: 013	
	8.96	V 39	00.18.27
		V 39	00.19.20
		V 39	00.20.22
		72	T15
	9.59	V 39	
		V 39	
		V 39	00.21.20
		73	T15
	11.02		
	0.00	V 33	00.21.37
		V 30	00.22.30
		V 27	00.23.32
		74	T16
	0.07	V 48	00.21.44
		V 45	00.22.38
		V 42	00.23.42
		75	T17
	0.48	V 48	
		V 45	
		V 42	00.24.17
		76	T17
	0.66	V 48	
		V 45	
		V 42	00.24.32
		77	T17

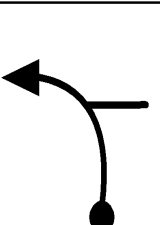
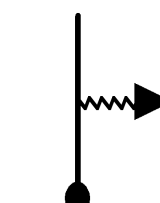
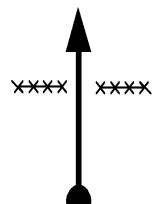
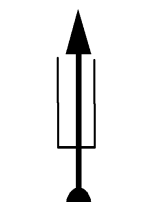
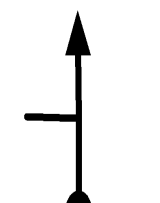
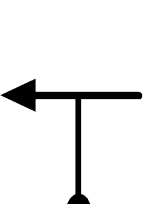
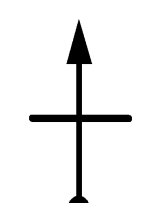
24/11/2018		Pág: 014	
	0.85	V 48	
		V 45	
		V 42	00.24.48
		78	T17
	1.00	V 48	
		V 45	
		V 42	00.25.01
		79	T17
	1.27	V 48	
		V 45	
		V 42	00.25.24
		80	T17
INICIO CALÇAMENTO			
	1.32	V 33	00.23.18
		V 33	00.24.18
		V 33	00.25.29
		81	T18
	1.49	V 33	
		V 33	
		V 33	00.25.47
		82	T18
	1.75	V 33	
		V 33	
		V 33	00.26.16
		83	T18
	1.88	V 33	
		V 33	
		V 33	00.26.30
		84	T18

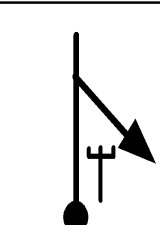
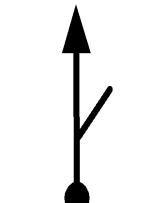
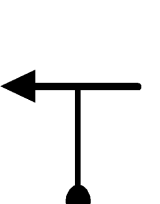
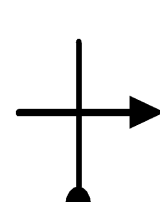
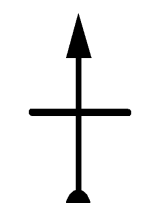
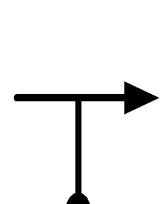
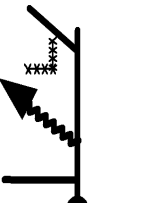
24/11/2018		Pág: 015	
	2.01	V 45	00.24.33
		V 42	00.25.34
		V 42	00.26.44
		85	T19
	2.19	V 45	
		V 42	
		V 42	00.26.59
		86	T19
	2.79	V 36	00.25.36
		V 36	00.26.41
		V 36	00.27.51
		87	T20
	3.73	V 36	
		V 36	
		V 36	00.29.25
		88	T20
	3.86	V 36	
		V 36	
		V 36	00.29.38
		89	T20
	4.08	V 36	
		V 36	
		V 36	00.30.00
		90	T20
	4.62	V 39	00.28.39
		V 36	00.29.44
		V 33	00.30.54
		91	T21

24/11/2018		Pág: 016	
	4.74	V 39	
		V 36	
		V 33	00.31.07
	92	T21	
	4.82	V 39	
		V 36	
		V 33	00.31.16
	93	T21	
	4.90	V 39	
		V 36	
		V 33	00.31.24
	94	T21	
	4.97	V 39	
		V 36	
		V 33	00.31.32
	95	T21	
	5.00	V 21	00.29.14
		V 18	00.30.22
		V 15	00.31.35
	96	T22	
	5.18	V 39	00.29.45
		V 36	00.30.58
		V 33	00.32.18
	97	T23	
	5.36	V 39	
		V 36	
		V 33	00.32.38
	98	T23	

24/11/2018		Pág: 017	
	5.37	V 39	
		V 36	
		V 33	00.32.39
	99	T23	
	5.50	V 39	
		V 36	
		V 33	00.32.53
	100	T23	
	5.55	V 21	00.30.19
		V 18	00.31.35
		V 15	00.32.59
	101	T24	
	5.74	V 39	00.30.51
		V 36	00.32.13
		V 33	00.33.44
	102	T25	
	5.91	V 39	
		V 36	
		V 33	00.34.03
	103	T25	
	5.93	V 39	
		V 36	
		V 33	00.34.05
	104	T25	
	5.96	V 39	
		V 36	
		V 33	00.34.08
	105	T25	

24/11/2018		Pág: 018	
	6.10	V 39	
		V 36	
		V 33	00.34.24
	106	T25	
	6.11	V 39	
		V 36	
		V 33	00.34.25
	107	T25	
	6.14	V 39	
		V 36	
		V 33	00.34.28
	108	T25	
	6.20	V 48	00.31.34
		V 45	00.32.59
		V 42	00.34.35
	109	T26	
	6.24	V 48	
		V 45	
		V 42	00.34.38
	110	T26	
	6.42	V 48	
		V 45	
		V 42	00.34.53
	111	T26	
	6.68	V 48	
		V 45	
		V 42	00.35.16
	112	T26	

24/11/2018		Pág: 019	
	6.89	V 48	
		V 45	
		V 42	00.35.34
	113	T26	
	7.17	V 48	
		V 45	
		V 42	00.35.58
	114	T26	
	7.23	V 48	
		V 45	
		V 42	00.36.03
	115	T26	
	7.28	V 48	
		V 45	
		V 42	00.36.07
	116	T26	
	7.33	V 48	
		V 45	
		V 42	00.36.11
	117	T26	
	7.51	V 48	
		V 45	
		V 42	00.36.27
	118	T26	
	7.77	N 3'	00.33.32
		N 2'	00.35.04
		N 2'	00.36.49
	119	T27	

24/11/2018		Pág: 020	
	7.77	V 15	00.36.32
		V 15	00.37.04
		V 15	00.38.49
	120	T28	
	7.85	V 15	
		V 15	
		V 15	00.39.08
	121	T28	
	7.88	V 30	00.36.58
		V 30	00.37.31
		V 30	00.39.16
	122	T29	
	7.93	V 30	
		V 30	
		V 30	00.39.22
	123	T29	
	8.06	V 39	00.37.20
		V 36	00.37.52
		V 33	00.39.37
	124	T30	
	8.14	V 39	
		V 36	
		V 33	00.39.46
	125	T30	

24/11/2018		Pág: 021	
	8.24	V 39	
		V 36	
		V 33	00.39.57
	126	T30	
	8.55	V 39	
		V 36	
		V 33	00.40.31
	127	T30	
	8.58	V 39	
		V 36	
		V 33	00.40.34
	128	T30	
	8.61	V 39	
		V 36	
		V 33	00.40.37
	129	T30	
	8.92	V 39	
		V 36	
		V 33	00.41.11
	130	T30	
	8.95	V 39	
		V 36	
		V 33	00.41.14
	131	T30	
ENTRE NOS			
EUCALIPTUS			
	8.99	V 39	
		V 36	
		V 33	00.41.19
	132	T30	

24/11/2018		Pág: 022	
	9.03		
	V 39		
	V 36		
	V 33	00.41.23	
	133	T30	
BAMBI			
	9.13		
	V 39		
	V 36		
	V 33	00.41.34	
	134	T30	
	9.50		
	V 39		
	V 36		
	V 33	00.42.14	
	135	T30	
	9.56		
	V 30	00.39.38	
	V 27	00.40.22	
	V 24	00.42.21	
	136	T31	
	9.59		
	V 30		
	V 27		
	V 24	00.42.25	
	137	T31	
	9.64		
	V 30		
	V 27		
	V 24	00.42.33	
	138	T31	
	9.83		
	V 39	00.40.11	
	V 36	00.40.58	
	V 33	00.43.01	
	139	T32	

24/11/2018		Pág: 023	
	9.95		
	V 39		
	V 36		
	V 33	00.43.14	
	140	T32	
	10.23		
	V 39		
	V 36		
	V 33	00.43.45	
	141	T32	
	10.25		
	V 39		
	V 36		
	V 33	00.43.47	
	142	T32	
ATENÇÃO			
EROSOES A FRENTE			
	10.57		
	V 36	00.41.19	
	V 33	00.42.12	
	V 33	00.44.22	
	143	T33	
	10.66		
	V 36		
	V 33		
	V 33	00.44.32	
	144	T33	
	10.71		
	V 36		
	V 33		
	V 33	00.44.37	
	145	T33	

24/11/2018		Pág: 024	
	10.91		
	N 3'	00.41.53	
	N 2'	00.42.49	
	N 1'	00.44.59	
	146	T34	
	10.91		
	0.00		
	V 36	00.44.53	
	V 36	00.44.49	
	V 36	00.45.59	
147	T35		
	0.22		
	V 36		
	V 36		
	V 36	00.46.21	
	148	T35	
	0.40		
	V 36		
	V 36		
	V 36	00.46.39	
	149	T35	
COSTEAR BARRANCO			
	0.62		
	V 36		
	V 36		
	V 36	00.47.01	
	150	T35	
CUIDADO BURACO			
	0.63		
	V 36		
	V 36		
	V 36	00.47.02	
	151	T35	

24/11/2018		Pág: 025	
	0.73	V 39	00.46.06
		V 36	00.46.02
		V 33	00.47.12
	152	T36	
	0.75	V 39	
		V 36	
		V 33	00.47.14
	153	T36	
	0.98	V 39	
		V 36	
		V 33	00.47.39
	154	T36	
	1.05	V 39	
		V 36	
		V 33	00.47.47
	155	T36	
	1.31	V 39	
		V 36	
		V 33	00.48.15
	156	T36	
	1.55	V 39	
		V 36	
		V 33	00.48.42
	157	T36	
	1.71	V 39	
		V 36	
		V 33	00.48.59
	158	T36	

24/11/2018		Pág: 026	
	1.80	V 39	
		V 36	
		V 33	00.49.09
	159	T36	
	1.87	V 42	00.47.51
		V 39	00.47.56
		V 36	00.49.16
	160	T37	
	1.95	V 42	
		V 39	
		V 36	00.49.24
	161	T37	
	2.00	V 42	
		V 39	
		V 36	00.49.29
	162	T37	
	2.07	V 42	
		V 39	
		V 36	00.49.36
	163	T37	
	2.11	V 42	
		V 39	
		V 36	00.49.40
	164	T37	
	2.17	V 42	
		V 39	
		V 36	00.49.46
	165	T37	

24/11/2018		Pág: 027	
	2.22	V 42	
		V 39	
		V 36	00.49.51
	166	T37	
	2.62	V 36	00.48.55
		V 33	00.49.05
		V 30	00.50.31
	167	T38	
	2.70	V 36	
		V 33	
		V 30	00.50.41
	168	T38	
	2.84	V 39	00.49.17
		V 36	00.49.29
		V 33	00.50.58
	169	T39	
	2.97	V 39	
		V 36	
		V 33	00.51.12
	170	T39	
	3.03	V 39	
		V 36	
		V 33	00.51.19
	171	T39	
	3.15	V 39	
		V 36	
		V 33	00.51.32
	172	T39	

24/11/2018		Pág: 028	
	3.33		
	V 39		
	V 36		
	V 33	00.51.51	
	173	T39	
	3.44		
	V 39		
	V 36		
	V 33	00.52.03	
	174	T39	
	3.52		
	V 39		
	V 36		
	V 33	00.52.12	
	175	T39	
	3.62		
	V 39		
	V 36		
	V 33	00.52.23	
	176	T39	
DESÇA			
	3.67		
	V 33	00.50.34	
	V 30	00.50.52	
	V 27	00.52.28	
	177	T40	
	3.76		
	V 33		
	V 30		
	V 27	00.52.40	
	178	T40	
	3.93		
	V 33		
	V 30		
	V 27	00.53.03	
	179	T40	

24/11/2018		Pág: 029	
	4.08		
	V 33		
	V 30		
	V 27	00.53.23	
	180	T40	
	4.17		
	V 33		
	V 30		
	V 27	00.53.35	
	181	T40	
	4.22		
	V 33		
	V 30		
	V 27	00.53.42	
	182	T40	
	4.31		
	V 33		
	V 30		
	V 27	00.53.54	
	183	T40	
	4.36		
	V 33		
	V 30		
	V 27	00.54.00	
	184	T40	
	4.51		
	V 39	00.52.06	
	V 36	00.52.33	
	V 33	00.54.20	
	185	T41	

24/11/2018		Pág: 030	
	4.60		
	V 39		
	V 36		
	V 33	00.54.30	
	186	T41	
	4.69		
	V 39		
	V 36		
	V 33	00.54.40	
	187	T41	
	4.73		
	V 39		
	V 36		
	V 33	00.54.44	
	188	T41	
	4.92		
	V 39		
	V 36		
	V 33	00.55.05	
	189	T41	
	5.05		
	N 3'	00.52.55	
	N 3'	00.53.27	
	N 2'	00.55.19	
	190	T42	
	5.05		
	V 33	00.55.55	
	V 33	00.56.27	
	V 33	00.57.19	
	191	T43	
	5.14		
	V 33		
	V 33		
	V 33	00.57.29	
	192	T43	

24/11/2018		Pág: 031	
	5.35	V 33	
		V 33	
		V 33	00.57.52
	193	T43	
	5.74	V 42	00.57.11
		V 42	00.57.43
		V 42	00.58.35
	194	T44	
	6.08	V 42	
		V 42	
		V 42	00.59.04
	195	T44	
	6.22	V 42	
		V 42	
		V 42	00.59.16
	196	T44	
	6.71		
	0.00		
		V 42	00.58.34
		V 39	00.59.06
		V 36	00.59.58
197	T45		
	0.02	V 42	
		V 39	
		V 36	01.00.00
	198	T45	

24/11/2018		Pág: 032	
	0.17	V 42	
		V 39	
		V 36	01.00.15
	199	T45	
	0.47	V 42	
		V 39	
		V 36	01.00.45
	200	T45	
	0.59	V 42	
		V 39	
		V 36	01.00.57
	201	T45	
	0.68	V 42	
		V 39	
		V 36	01.01.06
	202	T45	
	0.75	V 42	
		V 39	
		V 36	01.01.13
	203	T45	
	0.80	V 42	
		V 39	
		V 36	01.01.18
	204	T45	
SALAO			
	0.89	V 15	00.59.50
		V 15	01.00.28
		V 15	01.01.27
	205	T46	

24/11/2018		Pág: 033	
	0.97	N 1'	01.00.09
		N 1'	01.00.47
		N 1'	01.01.46
	206	T47	
	0.97	V 42	01.01.09
		V 39	01.01.47
		V 39	01.02.46
	207	T48	
	1.11	V 42	
		V 39	
		V 39	01.02.59
	208	T48	
	1.79	V 42	
		V 39	
		V 39	01.04.02
	209	T48	
	2.07	V 42	
		V 39	
		V 39	01.04.27
	210	T48	
	2.31	V 42	
		V 39	
		V 39	01.04.50
	211	T48	
	3.14	V 42	
		V 39	
		V 39	01.06.06
	212	T48	

24/11/2018		Pág: 034	
	3.16		
	V 54	01.04.17	
	V 51	01.05.09	
	V 48	01.06.08	
213	T49		
	3.60		
	V 42	01.04.46	
	V 36	01.05.40	
	V 33	01.06.41	
214	T50		
	3.70		
	V 42		
	V 36		
	V 33	01.06.52	
215	T50		
	3.80		
	V 42		
	V 36		
	V 33	01.07.03	
216	T50		
	3.94		
	V 42		
	V 36		
	V 33	01.07.18	
217	T50		
	3.98		
	V 42		
	V 36		
	V 33	01.07.22	
218	T50		
	4.08		
	V 42		
	V 36		
	V 33	01.07.33	
219	T50		

24/11/2018		Pág: 035	
CUIDADO EROSAO			
	4.31		
	V 42		
	V 36		
	V 33	01.07.58	
220	T50		
	4.44		
	V 42		
	V 36		
	V 33	01.08.13	
221	T50		
	4.62		
	V 42		
	V 36		
	V 33	01.08.32	
222	T50		
	4.78		
	V 42		
	V 36		
	V 33	01.08.50	
223	T50		
	5.23		
	V 42		
	V 36		
	V 33	01.09.39	
224	T50		
	5.37		
	V 42		
	V 36		
	V 33	01.09.54	
225	T50		

24/11/2018		Pág: 036	
	5.40		
	V 42		
	V 36		
	V 33	01.09.57	
226	T50		
	5.51		
	V 42		
	V 36		
	V 33	01.10.09	
227	T50		
CUIDADO EROSAO			
	5.74		
	V 42		
	V 36		
	V 33	01.10.34	
228	T50		
	5.87		
	V 42		
	V 36		
	V 33	01.10.49	
229	T50		
	6.05		
	V 42		
	V 36		
	V 33	01.11.08	
230	T50		
	6.21		
	V 42		
	V 36		
	V 33	01.11.26	
231	T50		
	6.31		
	V 39	01.08.39	
	V 36	01.10.11	
	V 33	01.11.37	
232	T51		

24/11/2018		Pág: 037	
	6.41		
	V 39		
	V 36		
	V 33	01.11.48	
	233	T51	
	6.49		
	V 42	01.08.55	
	V 36	01.10.29	
	V 33	01.11.56	
	234	T52	
	6.86		
	V 42		
	V 36		
	V 33	01.12.37	
	235	T52	
	6.96		
	V 42		
	V 36		
	V 33	01.12.48	
	236	T52	
	7.29		
	V 42		
	V 36		
	V 33	01.13.24	
	237	T52	
	7.37		
	V 42		
	V 36		
	V 33	01.13.32	
	238	T52	
	7.40		
	V 42		
	V 36		
	V 33	01.13.36	
	239	T52	







24/11/2018		Pág: 038	
	7.52		
	V 42		
	V 36		
	V 33	01.13.49	
	240	T52	
	7.65		
	V 42		
	V 36		
	V 33	01.14.03	
	241	T52	
	7.77		
	V 42		
	V 36		
	V 33	01.14.16	
	242	T52	
CUIDADO CEPOS			
	7.92		
	V 24	01.10.58	
	V 21	01.12.52	
	V 21	01.14.32	
	243	T53	
	7.95		
	V 24		
	V 21		
	V 21	01.14.37	
	244	T53	
	7.98		
	V 24		
	V 21		
	V 21	01.14.43	
	245	T53	



24/11/2018		Pág: 039	
	8.02		
	V 24		
	V 21		
	V 21	01.14.49	
	246	T53	
	8.04		
	V 24		
	V 21		
	V 21	01.14.53	
	247	T53	
	8.06		
	V 24		
	V 21		
	V 21	01.14.56	
	248	T53	
MUITA ATENÇÃO			
	8.10		
	V 39	01.11.25	
	V 36	01.13.23	
	V 33	01.15.03	
	249	T54	
	8.16		
	V 39		
	V 36		
	V 33	01.15.10	
	250	T54	
	8.20		
	V 39		
	V 36		
	V 33	01.15.14	
	251	T54	
	8.29		
	V 39		
	V 36		
	V 33	01.15.24	
	252	T54	



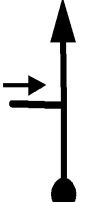
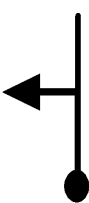

24/11/2018		Pág: 040	
	8.44	N 5'	01.11.56
		N 5'	01.13.57
		N 5'	01.15.40
	253	T55	
	8.44	V 45	01.16.56
		V 42	01.18.57
		V 42	01.20.40
	254	T56	
	8.53	V 45	
		V 42	
		V 42	01.20.48
	255	T56	
	8.90	V 45	
		V 42	
		V 42	01.21.20
	256	T56	
	9.05	V 45	
		V 42	
		V 42	01.21.32
	257	T56	
	10.17	V 45	
		V 42	
		V 42	01.23.08
	258	T56	
	10.55	0.00	
		V 54	01.19.45
		V 51	01.21.58
		V 48	01.23.41
	259	T57	

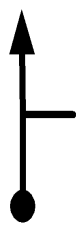
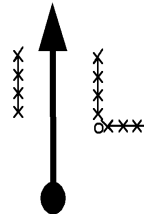
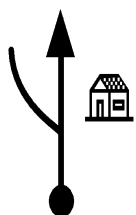
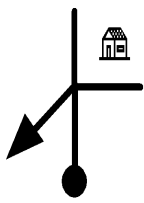
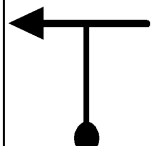
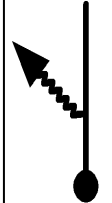
24/11/2018		Pág: 041	
	0.92	V 54	
		V 51	
		V 48	01.24.50
	260	T57	
	1.06	V 54	
		V 51	
		V 48	01.25.01
	261	T57	
	1.53	V 54	
		V 51	
		V 48	01.25.36
	262	T57	
	1.94	V 54	
		V 51	
		V 48	01.26.07
	263	T57	
	2.05	V 54	
		V 51	
		V 48	01.26.15
	264	T57	
	2.97	V 54	
		V 51	
		V 48	01.27.24
	265	T57	
	3.10	V 54	
		V 51	
		V 48	01.27.34
	266	T57	

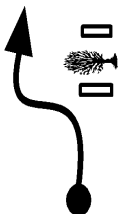
24/11/2018		Pág: 042	
	3.36	V 54	
		V 51	
		V 48	01.27.53
	267	T57	
	4.30	V 27	01.24.32
		V 27	01.27.01
		V 27	01.29.04
	268	T58	
	4.62	N 2'	01.25.14
		N 2'	01.27.44
		N 2'	01.29.46
	269	T59	
	4.62	V 39	01.27.14
		V 39	01.29.44
		V 45	01.31.46
	270	T60	
	5.36	V 39	
		V 39	
		V 45	01.32.45
	271	T60	
	5.55	V 51	01.28.40
		V 48	01.31.10
		V 45	01.33.01
	272	T61	
	5.91	V 51	
		V 48	
		V 45	01.33.29
	273	T61	

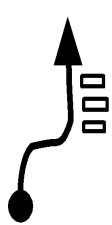
24/11/2018		Pág: 043	
	5.97		
	V 51		
	V 48		
	V 45	01.33.34	
	274	T61	
	6.23		
	V 51		
	V 48		
	V 45	01.33.55	
	275	T61	
	6.34		
	V 51		
	V 48		
	V 45	01.34.04	
	276	T61	
	6.88		
	V 51		
	V 48		
	V 45	01.34.47	
	277	T61	
	7.02		
	V 51		
	V 48		
	V 45	01.34.58	
	278	T61	
	7.06		
	V 51		
	V 48		
	V 45	01.35.01	
	279	T61	
	7.48		
	V 51		
	V 48		
	V 45	01.35.35	
	280	T61	

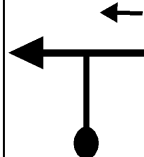
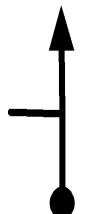
24/11/2018		Pág: 044	
	8.07		
	V 51		
	V 48		
	V 45	01.36.22	
	281	T61	
	8.32		
	V 24	01.31.56	
	V 24	01.34.38	
	V 24	01.36.42	
	282	T62	
	8.38		
	V 24		
	V 24		
	V 24	01.36.51	
	283	T62	
	8.42		
	V 24		
	V 24		
	V 24	01.36.57	
	284	T62	
	8.43		
	V 24		
	V 24		
	V 24	01.36.59	
	285	T62	
	8.53		
	V 51	01.32.27	
	V 48	01.35.09	
	V 45	01.37.14	
	286	T63	
CUIDADO			
PELO MEIO DO			
EUCALIPTO			
			
	9.51		
	V 15	01.33.36	
	V 15	01.36.23	
	V 15	01.38.32	
	287	T64	

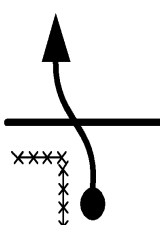
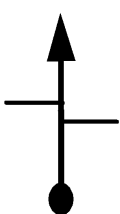
24/11/2018		Pág: 045	
	9.55		
	V 51	01.33.46	
	V 48	01.36.32	
	V 45	01.38.42	
	288	T65	
CUIDADO			
MOTOS			
			
	9.84		
	V 48	01.34.06	
	V 45	01.36.54	
	V 42	01.39.05	
	289	T66	
	9.89		
	V 48		
	V 45		
	V 42	01.39.09	
	290	T66	
	10.04		
	V 48		
	V 45		
	V 42	01.39.22	
	291	T66	
	10.19		
	V 48		
	V 45		
	V 42	01.39.35	
	292	T66	
	10.25		
	V 48		
	V 45		
	V 42	01.39.40	
	293	T66	

24/11/2018		Pág: 046	
	10.35		
	V 48		
	V 45		
	V 42	01.39.49	
	294	T66	
	10.55		
	V 48		
	V 45		
	V 42	01.40.06	
	295	T66	
	10.69		
	V 48		
	V 45		
	V 42	01.40.18	
	296	T66	
	10.86		
	N 3'	01.35.23	
	N 2'	01.38.16	
	N 2'	01.40.32	
	297	T67	
	10.86		
	V 54	01.38.23	
	V 51	01.40.16	
	V 48	01.42.32	
	298	T68	
	11.16		
	V 54		
	V 51		
	V 48	01.42.55	
	299	T68	

24/11/2018		Pág: 047	
	11.30		
	V 54		
	V 51		
	V 48	01.43.05	
	300	T68	
	11.36		
	V 54		
	V 51		
	V 48	01.43.10	
	301	T68	
	11.45		
	V 54		
	V 51		
	V 48	01.43.17	
	302	T68	
	11.47		
	V 54		
	V 51		
	V 48	01.43.18	
	303	T68	
	11.51		
	V 45	01.39.06	
	V 42	01.41.02	
	V 39	01.43.21	
	304	T69	
	11.81		
	V 45		
	V 42		
	V 39	01.43.49	
	305	T69	
	11.87		
	V 42	01.39.35	
	V 39	01.41.32	
	V 36	01.43.54	
	306	T70	

24/11/2018		Pág: 048	
	12.92		
	V 21	01.41.05	
	V 21	01.43.09	
	V 21	01.45.39	
	307	T71	
	13.01		
	N 1'	01.41.20	
	N 1'	01.43.25	
	N 1'	01.45.55	
	308	T72	
	13.01		
	0.00		
	V 42	01.42.20	
	V 39	01.44.25	
	V 33	01.46.55	
309	T73		
	0.08		
	V 42		
	V 39		
	V 33	01.47.03	
	310	T73	
	0.14		
	V 48	01.42.32	
	V 45	01.44.38	
	V 42	01.47.10	
	311	T74	
	0.93		
	V 33	01.43.32	
	V 30	01.45.41	
	V 27	01.48.18	
	312	T75	

24/11/2018		Pág: 049	
	1.24		
	V 33		
	V 30		
	V 27	01.48.59	
	313	T75	
	1.25		
	V 33		
	V 30		
	V 27	01.49.00	
	314	T75	
	1.28		
	V 48	01.44.10	
	V 45	01.46.23	
	V 42	01.49.04	
	315	T76	
	1.40		
	V 48		
	V 45		
	V 42	01.49.15	
	316	T76	
	1.42		
	V 48		
	V 45		
	V 42	01.49.16	
	317	T76	
	1.72		
	V 48		
	V 45		
	V 42	01.49.42	
	318	T76	
	2.05		
	V 48		
	V 45		
	V 42	01.50.10	
	319	T76	

24/11/2018		Pág: 050	
	2.36		
	N 1'	01.45.31	
	N 1'	01.47.49	
	N1'30s	01.50.37	
	320	T77	
	2.36		
	V 15	01.46.31	
	V 15	01.48.49	
	V 15	01.52.07	
	321	T78	
	2.51		
	V 36	01.47.07	
	V 36	01.49.25	
	V 36	01.52.43	
	322	T79	
	3.44		
	V 36		
	V 36		
	V 36	01.54.16	
	323	T79	
ATENÇÃO			
	3.87		
	V 36		
	V 36		
	V 36	01.54.59	
	324	T79	
	4.44		
	N 20'	01.50.20	
	N 20'	01.52.38	
	N 20'	01.55.56	
	325	T80	

24/11/2018		Pág: 051	
APOIO			
	4.44		
	0.00		
	V 36	02.10.20	
	V 36	02.12.38	
	V 36	02.15.56	
326	T81		
	0.23		
	V 36		
	V 36		
	V 36	02.16.19	
	327	T81	
	1.53		
	V 36		
	V 36		
	V 36	02.18.29	
	328	T81	
	1.59		
	V 54	02.12.59	
	V 51	02.15.17	
	V 48	02.18.35	
	329	T82	
	2.24		
	V 54		
	V 51		
	V 48	02.19.24	
	330	T82	
	2.29		
	V 54		
	V 51		
	V 48	02.19.27	
	331	T82	

24/11/2018		Pág: 052	
	2.33	V 48	02.13.48
		V 45	02.16.09
		V 42	02.19.30
	332	T83	
	2.44	V 48	
		V 45	
		V 42	02.19.40
	333	T83	
	2.65	V 48	
		V 45	
		V 42	02.19.58
	334	T83	
	2.68	V 48	
		V 45	
		V 42	02.20.00
	335	T83	
	2.79	V 45	02.14.23
		V 42	02.16.46
		V 39	02.20.10
	336	T84	
	3.01	V 45	
		V 42	
		V 39	02.20.30
	337	T84	
	3.03	V 45	
		V 42	
		V 39	02.20.32
	338	T84	

24/11/2018		Pág: 053	
	3.45	V 42	02.15.16
		V 39	02.17.43
		V 36	02.21.11
	339	T85	
	3.51	V 54	02.15.21
		V 51	02.17.48
		V 48	02.21.17
	340	T86	
	4.13	V 54	
		V 51	
		V 48	02.22.03
	341	T86	
	4.90	V 21	02.16.53
		V 21	02.19.26
		V 21	02.23.01
	342	T87	
	5.11	N 2'	02.17.29
		N 2'	02.20.02
		N 2'	02.23.37
	343	T88	
	5.11	V 39	02.19.29
		V 39	02.22.02
		V 39	02.25.37
	344	T89	
	5.41	V 54	02.19.57
		V 51	02.22.30
		V 48	02.26.05
	345	T90	

24/11/2018		Pág: 054	
	6.05	V 54	
		V 51	
		V 48	02.26.53
	346	T90	
	7.12	V 45	02.21.51
		V 42	02.24.31
		V 39	02.28.13
	347	T91	
	7.14	V 45	
		V 42	
		V 39	02.28.15
	348	T91	
	7.28	V 45	
		V 42	
		V 39	02.28.28
	349	T91	
	7.38	V 45	
		V 42	
		V 39	02.28.37
	350	T91	
	7.49	V 45	
		V 42	
		V 39	02.28.47
	351	T91	
	7.59	V 45	
		V 42	
		V 39	02.28.56
	352	T91	

24/11/2018		Pág: 055	
	7.73	V 45	
		V 42	
		V 39	02.29.09
		353	T91
	7.87	V 45	
		V 42	
		V 39	02.29.22
		354	T91
	7.96	V 45	
		V 42	
		V 39	02.29.31
		355	T91
	8.07	V 45	
		V 42	
		V 39	02.29.41
		356	T91
	8.17	V 45	
		V 42	
		V 39	02.29.50
		357	T91
	8.30	V 45	
		V 42	
		V 39	02.30.02
		358	T91
	8.40	V 45	
		V 42	
		V 39	02.30.11
		359	T91

24/11/2018		Pág: 056	
	8.67	V 45	
		V 42	
		V 39	02.30.36
		360	T91
	8.70	V 42	02.23.57
		V 39	02.26.46
		V 36	02.30.39
		361	T92
	8.73	V 42	
		V 39	
		V 36	02.30.42
		362	T92
	9.16	V 42	
		V 39	
		V 36	02.31.25
		363	T92
	9.52	V 39	02.25.08
		V 36	02.28.02
		V 33	02.32.01
		364	T93
	9.59	V 39	
		V 36	
		V 33	02.32.08
		365	T93

24/11/2018		Pág: 057	
	9.75	V 39	
		V 36	
		V 33	02.32.26
		366	T93
	9.80	V 39	
		V 36	
		V 33	02.32.31
		367	T93
	9.94	V 39	
		V 36	
		V 33	02.32.47
		368	T93
	10.01	V 48	02.25.53
		V 45	02.28.51
		V 42	02.32.54
		369	T94
	10.16	V 48	
		V 45	
		V 42	02.33.07
		370	T94
	10.34	V 48	
		V 45	
		V 42	02.33.23
		371	T94
ATENÇÃO			
	10.89	N 3'	02.26.59
		N 3'	02.30.01
		N2'30"	02.34.10
		372	T95

24/11/2018		Pág: 058	
	10.89	V 36	02.29.59
		V 36	02.33.01
		V 36	02.36.40
	373	T96	
	11.38	V 36	
		V 36	
		V 36	02.37.29
	374	T96	
	11.90	0.00	
		V 36	02.31.40
		V 36	02.34.42
		V 36	02.38.21
375	T97		
	0.74	V 36	
		V 36	
		V 36	02.39.35
	376	T97	
	1.41	V 48	02.34.01
		V 45	02.37.03
		V 42	02.40.42
	377	T98	
	2.15	V 48	
		V 45	
		V 42	02.41.45
	378	T98	

24/11/2018		Pág: 059	
	2.20	V 33	02.35.00
		V 30	02.38.07
		V 27	02.41.49
	379	T99	
	2.50	V 33	
		V 30	
		V 27	02.42.29
	380	T99	
	2.51	V 33	
		V 30	
		V 27	02.42.31
	381	T99	
	2.56	V 48	02.35.39
		V 45	02.38.50
		V 42	02.42.37
	382	T100	
	2.66	V 48	
		V 45	
		V 42	02.42.46
	383	T100	
	2.68	V 48	
		V 45	
		V 42	02.42.48
	384	T100	
	2.99	V 48	
		V 45	
		V 42	02.43.14
	385	T100	

24/11/2018		Pág: 060	
	3.31	V 48	
		V 45	
		V 42	02.43.42
	386	T100	
	3.64	N 1'	02.37.00
		N 1'	02.40.16
		N1'30s	02.44.10
	387	T101	
	3.64	V 15	02.38.00
		V 15	02.41.16
		V 15	02.45.40
	388	T102	
	3.78	V 36	02.38.34
		V 36	02.41.50
		V 36	02.46.14
	389	T103	
	4.11	V 54	02.39.07
		V 51	02.42.23
		V 48	02.46.47
	390	T104	
	5.02	V 54	
		V 51	
		V 48	02.47.55
	391	T104	
	5.16	V 54	
		V 51	
		V 48	02.48.05
	392	T104	

24/11/2018		Pág: 061	
	5.20		
	V 54		
	V 51		
	V 48	02.48.08	
	393	T104	
	5.32		
	V 48	02.40.28	
	V 45	02.43.48	
	V 42	02.48.17	
	394	T105	
	5.65		
	V 48		
	V 45		
	V 42	02.48.46	
	395	T105	
	5.96		
	N 1'	02.41.16	
	N 1'	02.44.39	
	N1'30s	02.49.12	
	396	T106	
	5.96		
	V 15	02.42.16	
	V 15	02.45.39	
	V 15	02.50.42	
	397	T107	
	6.10		
	V 39	02.42.49	
	V 39	02.46.13	
	V 39	02.51.16	
	398	T108	
	7.47		
	0.00		
	V 33	02.44.56	
	V 30	02.48.19	
		V 27 02.53.22	
	399	T109	

24/11/2018		Pág: 062	
ATENÇÃO			
	0.63		
	N 30s	02.46.04	
	N 30s	02.49.35	
	N 30s	02.54.46	
	400	T110	
	0.63		
	V 33	02.46.34	
	V 30	02.50.05	
	V 27	02.55.16	
	401	T111	
	0.67		
	V 42	02.46.39	
	V 39	02.50.10	
	V 36	02.55.22	
	402	T112	
	0.83		
	V 42		
	V 39		
	V 36	02.55.38	
	403	T112	
	0.99		
	V 42		
	V 39		
	V 36	02.55.54	
	404	T112	
	1.04		
	V 42		
	V 39		
	V 36	02.55.59	
	405	T112	

24/11/2018		Pág: 063	
	1.24		
	V 42		
	V 39		
	V 36	02.56.19	
	406	T112	
	1.33		
	V 42		
	V 39		
	V 36	02.56.28	
	407	T112	
	1.45		
	V 42		
	V 39		
	V 36	02.56.40	
	408	T112	
	1.60		
	V 39	02.47.59	
	V 36	02.51.36	
	V 33	02.56.55	
	409	T113	
	1.67		
	V 39		
	V 36		
	V 33	02.57.02	
	410	T113	
	1.83		
	V 39		
	V 36		
	V 33	02.57.20	
	411	T113	
	2.14		
	V 48	02.48.48	
	V 45	02.52.30	
	V 42	02.57.53	
	412	T114	

24/11/2018		Pág: 064	
	2.18	V 48	
		V 45	
		V 42	02.57.57
	413	T114	
	2.51	V 48	
		V 45	
		V 42	02.58.25
	414	T114	
ATENÇÃO			
	2.87	N 2'	02.49.43
		N 2'	02.53.28
		N 1'	02.58.56
	415	T115	
PELO ACOSTAMENTO			
	2.87	V 36	02.51.43
		V 36	02.55.28
		V 36	02.59.56
	416	T116	
	3.37	V 36	02.52.33
		V 36	02.56.18
		V 42	03.00.46
	417	T117	
	3.90		
	0.00	V 36	02.53.26
		V 36	02.57.11
		V 42	03.01.31
	418	T118	

24/11/2018		Pág: 065	
	0.74	V 36	
		V 36	
		V 42	03.02.35
	419	T118	
	1.64	V 36	
		V 36	
		V 42	03.03.52
	420	T118	
	1.86	V 36	
		V 36	
		V 42	03.04.11
	421	T118	
	2.26	V 36	
		V 36	
		V 42	03.04.45
	422	T118	
	2.40	V 36	
		V 36	
		V 42	03.04.57
	423	T118	
	2.61	V 39	02.57.47
		V 42	03.01.32
		V 42	03.05.15
	424	T119	

24/11/2018		Pág: 066	
	2.88	V 39	
		V 42	
		V 42	03.05.38
	425	T119	
	3.16	V 39	
		V 42	
		V 42	03.06.02
	426	T119	
	3.84	V 42	02.59.41
		V 39	03.03.17
		V 36	03.07.01
	427	T120	
	4.19	V 42	
		V 39	
		V 36	03.07.36
	428	T120	
	4.24	V 42	
		V 39	
		V 36	03.07.41
	429	T120	
	4.28	V 42	
		V 39	
		V 36	03.07.45
	430	T120	
	4.35	V 42	
		V 39	
		V 36	03.07.52
	431	T120	

CORREGO

	4.40
	V 42
	V 39
	V 36 03.07.57
	432 T120
	4.41
	V 42
	V 39
	V 36 03.07.58
	433 T120
	4.53
	V 42
	V 39
	V 36 03.08.10
	434 T120
	4.58
	V 42
	V 39
	V 36 03.08.15
	435 T120
	4.81
	V 42
	V 39
	V 36 03.08.38
	436 T120
CUIDADO	
	4.83
	V 42
	V 39
	V 36 03.08.40
	437 T120

	4.91
	V 42
	V 39
	V 36 03.08.48
	438 T120
	4.98
	V 42
	V 39
	V 36 03.08.55
	439 T120
	5.09
	V 42
	V 39
	V 36 03.09.06
	440 T120
	5.65
	V 42
	V 39
	V 36 03.10.02
	441 T120
	5.77
	V 42
	V 39
	V 36 03.10.14
	442 T120
	5.96
	V 42
	V 39
	V 36 03.10.33
	443 T120
	6.02
	V 42
	V 39
	V 36 03.10.39
	444 T120

	6.25
	V 42
	V 39
	V 36 03.11.02
	445 T120
	6.28
	V 42
	V 39
	V 36 03.11.05
	446 T120
	6.40
	V 39 03.03.20
	V 36 03.07.14
	V 33 03.11.17
	447 T121
	6.45
	N 3' 03.03.25
	N 3' 03.07.19
	N 3' 03.11.22
	448 T122
CORREGO	
	6.45
	V 39 03.06.25
	V 36 03.10.19
	V 33 03.14.22
	449 T123
	6.46
	V 39
	V 36
	V 33 03.14.23
	450 T123
	6.55
	V 33 03.06.34
	V 33 03.10.29
	V 33 03.14.33
	451 T124

24/11/2018		Pág: 070	
	6.72		
	V 33		
	V 33		
	V 33	03.14.51	
	452	T124	
APOS PONTE, POR DENTRO BARRANCO			
	6.80		
	V 45	03.07.01	
	V 42	03.10.56	
	V 39	03.15.00	
	453	T125	
	7.67		
	V 45		
	V 42		
	V 39	03.16.21	
	454	T125	
	7.81		
	V 45		
	V 42		
	V 39	03.16.33	
	455	T125	
	7.96		
	V 45		
	V 42		
	V 39	03.16.47	
	456	T125	
	8.10		
	V 45		
	V 42		
	V 39	03.17.00	
	457	T125	

24/11/2018		Pág: 071	
	8.53		
	V 45		
	V 42		
	V 39	03.17.40	
	458	T125	
	8.80		
	V 45		
	V 42		
	V 39	03.18.05	
	459	T125	
	8.91		
	V 45		
	V 42		
	V 39	03.18.15	
	460	T125	
	9.05		
	V 45		
	V 42		
	V 39	03.18.28	
	461	T125	
	9.36		
	V 45		
	V 42		
	V 39	03.18.57	
	462	T125	
	9.50		
	V 45		
	V 42		
	V 39	03.19.09	
	463	T125	
	9.91		
	V 45		
	V 42		
	V 39	03.19.47	
	464	T125	

24/11/2018		Pág: 072	
	10.34		
	V 45		
	V 42		
	V 39	03.20.27	
	465	T125	
	10.68		
	V 45		
	V 42		
	V 39	03.20.58	
	466	T125	
	11.01		
	V 45		
	V 42		
	V 39	03.21.29	
	467	T125	
VALO			
	11.38		
	V 45		
	V 42		
	V 39	03.22.03	
	468	T125	
	11.59		
	V 45		
	V 42		
	V 39	03.22.22	
	469	T125	
	12.00		
	V 27	03.13.57	
	V 24	03.18.22	
	V 21	03.23.00	
	470	T126	
	12.03		
	V 27		
	V 24		
	V 21	03.23.05	
	471	T126	

24/11/2018		Pág: 073	
	12.12	N 1'	03.14.13
		N 1'	03.18.40
		N 1'	03.23.21
	472	T127	
	12.12		
	0.00		
		V 42	03.15.13
		V 39	03.19.40
		V 36	03.24.21
473	T128		
	0.10		
		V 42	
		V 39	
		V 36	03.24.31
474	T128		
	0.14		
		V 42	
		V 39	
		V 36	03.24.35
475	T128		
	0.43		
		V 42	
		V 39	
		V 36	03.25.04
476	T128		
	0.58		
		V 42	
		V 39	
		V 36	03.25.19
477	T128		

24/11/2018		Pág: 074		
	0.69	V 42		
		V 39		
		V 36	03.25.30	
	478	T128		
	1.44	V 42		
		V 39		
		V 36	03.26.45	
	479	T128		
	1.63	V 42		
		V 39		
		V 36	03.27.04	
	480	T128		
	1.69	V 42		
		V 39		
		V 36	03.27.10	
	481	T128		
	2.08	V 42		
		V 39		
		V 36	03.27.49	
	482	T128		
	2.13	N 3'	03.18.16	
		N 3'	03.22.56	
		N 2'	03.27.54	
	483	T129		

24/11/2018		Pág: 075		
	2.13	V 33	03.21.16	
		V 33	03.25.56	
		V 33	03.29.54	
	484	T130		
	2.14	V 33		
		V 33		
		V 33	03.29.55	
	485	T130		
	2.23	V 33		
		V 33		
		V 33	03.30.05	
	486	T130		
	2.42	V 33		
		V 33		
		V 33	03.30.25	
	487	T130		
	2.62	V 33		
		V 33		
		V 33	03.30.47	
	488	T130		
	2.69	V 33		
		V 33		
		V 33	03.30.55	
	489	T130		
	3.12	V 33		
		V 33		
		V 33	03.31.42	
	490	T130		

24/11/2018		Pág: 076	
	3.25		
	V 33		
	V 33		
	V 33	03.31.56	
	491	T130	
	3.64		
	V 33		
	V 33		
	V 33	03.32.38	
	492	T130	
	3.90		
	V 39	03.24.29	
	V 36	03.29.09	
	V 33	03.33.07	
	493	T131	
	4.54		
	V 39		
	V 36		
	V 33	03.34.17	
	494	T131	
	4.82		
	V 39		
	V 36		
	V 33	03.34.47	
	495	T131	
	4.89		
	V 39		
	V 36		
	V 33	03.34.55	
	496	T131	
	5.07		
	V 39		
	V 36		
	V 33	03.35.14	
	497	T131	

24/11/2018		Pág: 077	
	5.31		
	V 39		
	V 36		
	V 33	03.35.41	
	498	T131	
	5.32		
	V 39		
	V 36		
	V 33	03.35.42	
	499	T131	
	5.50		
	V 39		
	V 36		
	V 33	03.36.01	
	500	T131	
	5.78		
	V 39		
	V 36		
	V 33	03.36.32	
	501	T131	
	5.85		
	V 39		
	V 36		
	V 33	03.36.40	
	502	T131	
	6.03		
	V 39		
	V 36		
	V 33	03.36.59	
	503	T131	
ESCOLHA			
ATOLEIRO FUNDO			
	6.31		
	V 39		
	V 36		
	V 33	03.37.30	
	504	T131	



24/11/2018		Pág: 078	
	6.40		
	N 3'	03.28.20	
	N 2'	03.33.19	
	N 1'	03.37.40	
	505	T132	
	6.40		
	V 36	03.31.20	
	V 36	03.35.19	
	V 42	03.38.40	
	506	T133	
	6.58		
	V 36		
	V 36		
	V 42	03.38.55	
	507	T133	
	6.76		
	V 36		
	V 36		
	V 42	03.39.10	
	508	T133	
	8.78		
	V 36		
	V 36		
	V 42	03.42.04	
	509	T133	
	9.61		
	0.00		
	V 39	03.36.41	
	V 36	03.40.40	
	V 33	03.43.15	
510	T134		

24/11/2018		Pág: 079	
	0.27	V 42	03.37.06
		V 39	03.41.07
		V 36	03.43.44
	511	T135	
	0.35	V 42	
		V 39	
		V 36	03.43.52
	512	T135	
	0.40	V 42	
		V 39	
		V 36	03.43.57
	513	T135	
	0.56	V 42	
		V 39	
		V 36	03.44.13
	514	T135	
	0.75	V 42	
		V 39	
		V 36	03.44.32
	515	T135	
	0.84	V 42	
		V 39	
		V 36	03.44.41
	516	T135	
	0.87	V 42	
		V 39	
		V 36	03.44.44
	517	T135	

24/11/2018		Pág: 080	
	1.09	V 42	
		V 39	
		V 36	03.45.06
	518	T135	
	1.21	V 42	
		V 39	
		V 36	03.45.18
	519	T135	
	1.30	V 42	
		V 39	
		V 36	03.45.27
	520	T135	
	1.39	V 42	
		V 39	
		V 36	03.45.36
	521	T135	
	1.59	V 42	
		V 39	
		V 36	03.45.56
	522	T135	
	1.61	V 42	
		V 39	
		V 36	03.45.58
	523	T135	
	1.80	V 42	
		V 39	
		V 36	03.46.17
	524	T135	

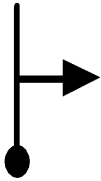
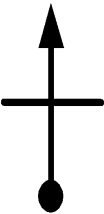
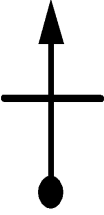
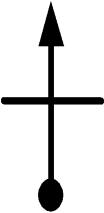
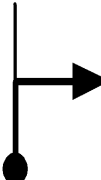
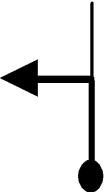
24/11/2018		Pág: 081	
	1.96	V 42	
		V 39	
		V 36	03.46.33
	525	T135	
	2.08	V 42	
		V 39	
		V 36	03.46.45
	526	T135	
	2.15	V 42	
		V 39	
		V 36	03.46.52
	527	T135	
	2.20	V 42	
		V 39	
		V 36	03.46.57
	528	T135	
	2.28	N 2'	03.39.58
		N 2'	03.44.13
		N 2'	03.47.05
	529	T136	
	2.28	V 24	03.41.58
		V 24	03.46.13
		V 24	03.49.05
	530	T137	
	2.47	V 24	
		V 24	
		V 24	03.49.34
	531	T137	

24/11/2018		Pág: 082	
	2.67		
	0.00		
	V 24	03.42.56	
	V 24	03.47.11	
	V 24	03.50.04	
	532	T138	
	0.07		
	V 24		
	V 24		
	V 24	03.50.14	
		533	T138
	0.15		
	V 24		
	V 24		
	V 24	03.50.26	
		534	T138
	0.23		
	V 24		
	V 24		
	V 24	03.50.38	
		535	T138
	0.31		
	V 24		
	V 24		
	V 24	03.50.50	
		536	T138
	0.42		
	V 24		
	V 24		
	V 24	03.51.07	
		537	T138

24/11/2018		Pág: 083	
	0.46		
	V 24	03.44.05	
	V 24	03.48.20	
	V 24	03.51.13	
		538	T138
FIM DE PROVA !!			
			
www.t15.com.br			
OBRIGADO A PRESENÇA DE TODOS!!!			
UMA BOA VIAGEM DE VOLTA PARA SUAS CASAS..			
E SE PREPAREM, NOS DIAS 10/11 FEVEREIRO, A GENTE SE ENCONTRA NO ENDURO DA LUA CHEIA, O MAIOR ENDURO NOTURNO DO BRASIL...VENHA VOÇE E TRAGA SEU AMIGO PARA FAZER PARTE DESTA HISTORIA.....			
BRAPPPPPP!!!!!!!!!!!!!!!!!!!! !!!!			
Tempo de Prova			
MÉDIA A 03:44:05			
MÉDIA B 03:48:20			
MÉDIA C 03:51:13			
FIM			