

INICIO

MÉDIA B







6 ENDURO AMIGOS NA TRILHA
01 e 02 de Janeiro / 2015



IMPORTANTE

PLANILHA TERMICA
FITA ADESIVA DO LADO DE
TRÁS. NÃO USE CANETA
MARCA TEXTO,
USE CANETA ESFEROGRÁFICA
OU HIDROGRÁFICA

DIRETORES DE PROVA:
DIOGES OSELLAME
CLEBSON OSELLAME
REALIZAÇÃO: AMIGOS NA TRILHA
NOS TRECHOS URBANOS
PREVALECEM AS LEIS
DO CÓDIGO NACIONAL
DETRANSPITO. É OBRIGAÇÃO
RESPEITAR AS
PROPRIEDADES
ALHEIAS E OS MORADORES.
A ORGANIZAÇÃO NÃO SE
RESPONSABILIZA POR PASSAR
PROGRAMAÇÃO DE NAVEGAÇÃO.
É OBRIGAÇÃO DO PILOTO
CONFERIR A PROGRAMAÇÃO DO
NAVEGADOR.
LARGADA - 14:00 HS
CTG TIO MILLO
NEUTRO PRINCIPAL
LOCAL DA LARGADA
CHEGADA NO MESMO
LOCAL DA LARGADA
1 ETAPA KM
2 ETAPA KM
TOTAL KM
LEVANTAMENTO DA PROVA
COM MOTO CRF 230 COM
PNEU DIANTEIRO NOVO
E 12 LIBRAS

 CUIDADO
  ATENÇÃO
   MUITA ATENÇÃO





Tempo de Prova



MÉDIA B 02:54:47







AFERIÇÃO

AFERIR

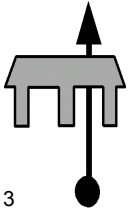
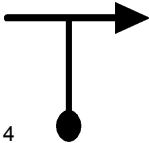
0.00	
AFER	1 

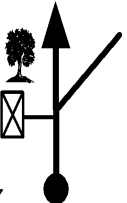
0.24	
AFER	2 

0.35	
AFER	3
0.37	
AFER	4
LOMBADA	
0.63	
AFER	5
1.46	
AFER	6
1.76	
AFER	7
AFERIR!!	
2.220	
0.00	
AFER	8



INICIO DE PROVA

BOA SORTE!!

0.00 V 25 00.00.00 T1	
0.24 V 25 T1	
0.41 V 25 T1	
0.54 V 25 T1	
0.58 V 21 00.01.24 T2	

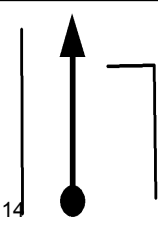
0.74	
V 21	
T2	14

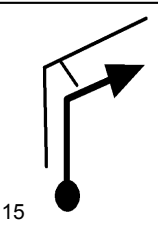
0.76	
V 21	
T2	15

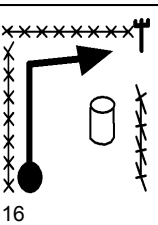
0.78	
V 21	
T2	16

por baixo da casinha

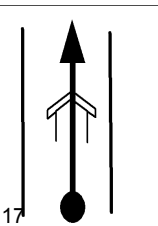
0.91	
V 21	
T2	17

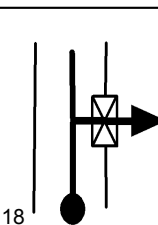
0.94	
V 21	
T2	18

costear cerca

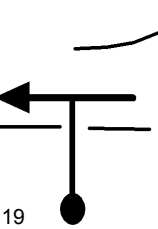
0.95	
V 18 00.02.27	
T3	19

0.99	
V 18	
T3	20

bamp

1.01	
V 18	
T3	21

1.03	
V 33 00.02.43	
T4	22

1.05	
V 33	
T4	23

PONTE!!

PERIGO!

1.14	
V 33	
T4	24

BAMP

1.58	
V 33	
T4	25

COSTEAR MATO!!

1.67

V 33

T4

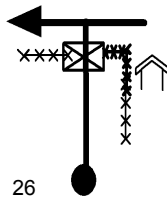

26

COSTEAR MATO!!

1.85

V 33

T4

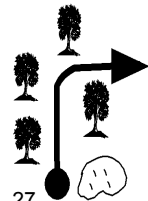

27

COSTEAR MATO!!

1.96

V 33

T4

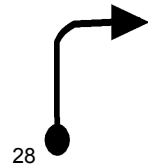

28

2.20

V 33

T4



29

BAMP

2.24

V 33

T4



30

BAMP

2.26

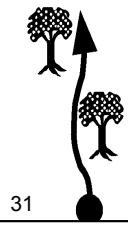

V 33

T4

31

2.31

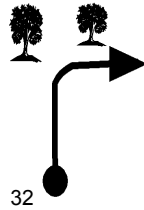

V 30 00.05.03

T5

32

VALO

2.34

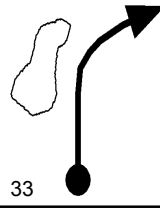

V 30

T5

33

VALO

2.37



V 30

T5

34

VALO

2.39

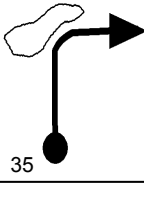

V 30

T5

35

2.43	
V 30	
T5 36	
2.52	
NI'30s 00.05.28	
T6 37	
2.52	
0.00	
V 20 00.06.58 T7 38	
0.04	
V 20	
T7 39	
0.13	
V 20	
T7 40	
0.18	
V 20	
T7 41	

0.20	
V 33 00.07.34	
T8	42

COSTEAR CERCA

0.36	
V 33	
T8	43

COSTEAR CERCA

0.72	
V 33	
T8	44

0.83	
V 33	
T8	45

1.16	
V 33	
T8	46

COSTEAR CERCA

1.26	
V 33	
T8	47

1.61	
V 30 00.10.08	
T9	48

PELO

TRILHO

DO

GADO!!

1.64	
V 30	
T9	49

1.68	
V 30	
T9	50

BAMP

1.70	
V 30	
T9	51

DENTRO DO RIO

BAMP

1.74	
V 36 00.10.23	
T10	52

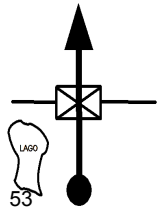
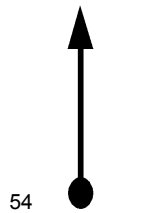
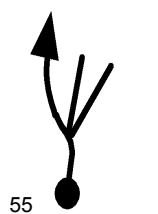
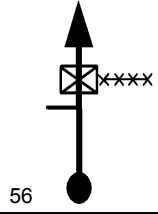
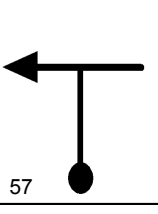
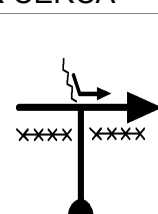
1.80	
V 36	53
T10	
BAMP	
1.96	
V 36	54
T10	
ENTRE NO MATO	
2.06	
V 30 00.10.55	55
T11	
2.12	
V 30	56
T11	
2.16	
V 30	57
T11	
COSTEAR CERCA	
2.31	
V 33 00.11.25	58
T12	

2.46

V 33

T12

59

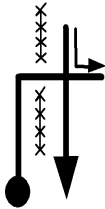

BAMP

2.52

V 33

T12

60



BAMP

2.58

V 33

T12

61

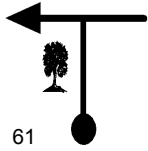

2.61

V 33

T12

62

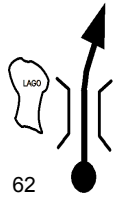

COSTEAR CERCA

2.65

V 33

T12

63

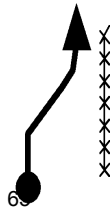

2.71	
V 33	
T12	64
COSTEAR CERCA	
2.73	
V 33	
T12	65
2.83	
N 2' 00.12.22	
T13	66
2.83	
V 30 00.14.22	
T14	67
2.89	
V 30	
T14	68
2.90	
V 30	
T14	69

NAO ERRE

2.95



V 30



T14

70

3.01

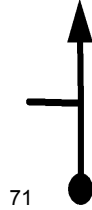

V 33 00.14.44

T15

71

3.09

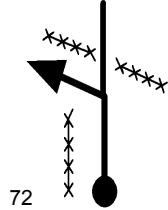

V 33

T15

72

BAMP

3.16

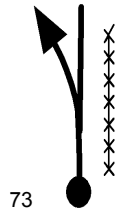

V 33

T15

73

COSTEAR CERCA

3.26

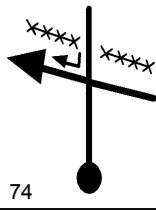

V 33

T15

74

3.43

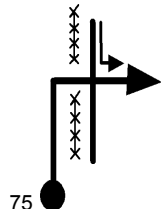

V 30 00.15.29

T16

75

NAO ERRE

3.49

V 30

T16



3.54

V 33 00.15.43

T17



COSTEAR CERCA

3.63

V 33

T17

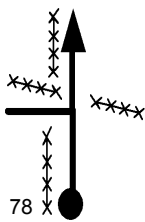

COSTEAR CERCA

3.69

V 33

T17

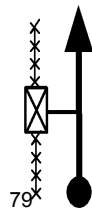

COSTEAR CALIPO

DA ESQUERDA

3.78

V 33

T17

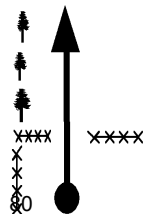

ATENÇÃO

3.92

V 33



T17

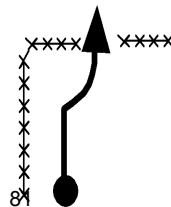

COESTEAR EUCALIPTO

4.06

V 33

T17

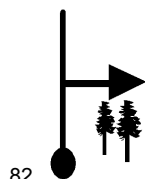

CUIDADO CEPO

4.11

V 27 00.16.45

T18

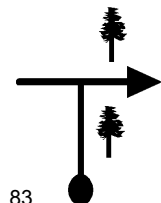

BAMP

4.18

V 27

T18



BAMP

4.25

V 27

T18

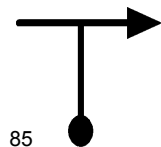

BAMP

4.30

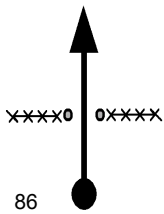

V 27

T18

86

4.34

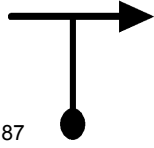

V 27

T18

87

4.37

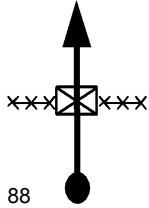

V 27

T18

88

4.38



V 27

T18

89

4.47

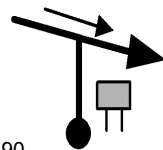

V 33 00.17.33

T19

90

PERIGO!!

4.54

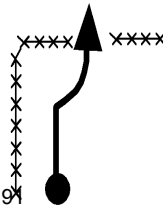

V 33

T19

91



BAMP

4.68

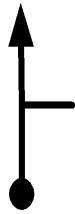

V 24 00.17.56

T20

92

4.73



V 24

T20

93

4.79



V 24

T20

94

4.92

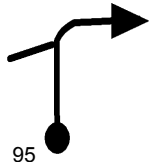

V 36 00.18.32

T21

95

5.06



V 36

T21

96

5.18





V 36

T21

97

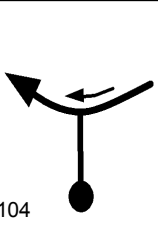
5.30	
V 36	
T21	98
5.61	
N 2' 00.19.41	
T22	99
5.61	
0.00	
V 30 00.21.41	100
T23	
0.12	
V 30 00.21.55	
T24	101
0.29	
V 30	
T24	102
BURACO	
PELA DIREITA	
0.31	
V 30	
	T24
	103

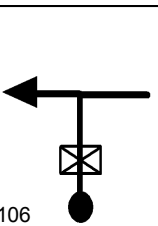
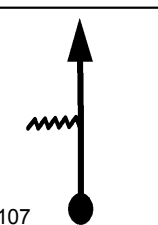
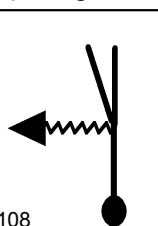
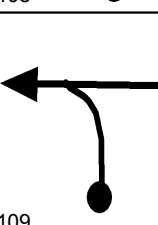
0.35	
V 36 00.22.23	
T25	104
0.66	
N 1' 00.22.54	
T26	105
0.66	
V 30 00.23.54	
T27	106
0.78	
V 30	
T27	107
1.08	
V 30 00.24.44	
T28	108
1.31	
V 30	
T28	109

POSTE TBG

1.34	
V 30	
T28 110	

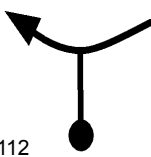

1.58	
V 30	
T28 111	

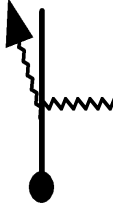
1.76	
V 30 00.26.06	
T29 112	

2.01	
V 42 00.26.36	
T30 113	

2.05	
V 42	
T30 114	

EROSÕES

2.27	
V 30 00.26.58	
 T31 115	

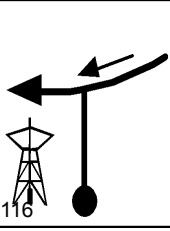
2.51	
V 33 00.27.27	
T32	116

BAMP

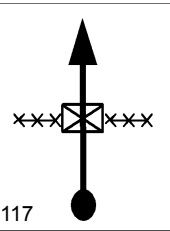
2.64	
V 33	
T32	117

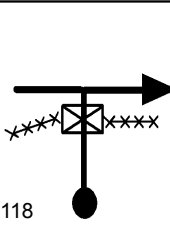
2.71	
V 33	
T32	118

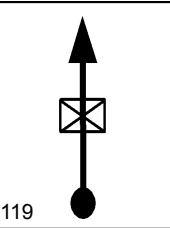
2.82	
V 33	
T32	119

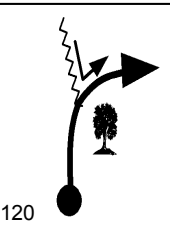

2.87	
V 36 00.28.06	
T33	120

3.14	
V 36	
T33	121

3.16	
V 36	
T33	122

3.21	
V 36	
T33	123

3.26	
V 36	
T33	124

EROSÕES

3.36	
V 33 00.28.55	
T34	125

3.42	
V 33	
T34	126

BAMP

3.54

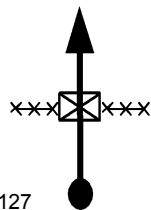

V 33

T34

127

3.63

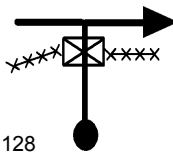

V 33

T34

128

3.77

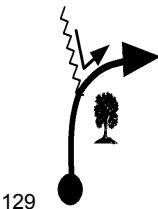

V 36 00.29.40

T35

129

4.04



V 36

T35

130

COSTEAR CERCA

4.25



V 30 00.30.28

T36

131

BAMP

4.43

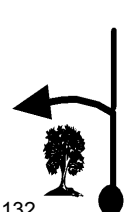

V 33 00.30.49

T37

132

4.52

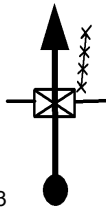

V 33

T37 133

4.63



V 33

T37 134

4.77



V 33

T37 135

4.99



V 33

T37 136

COSTEAR CERCA

5.04

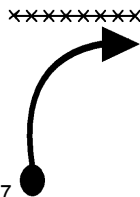

V 33

T37 137





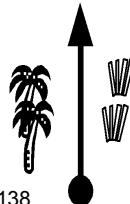

BAMP

5.10





V 24 00.32.02

T38 138

5.20	
NI'30s 00.32.17	
T39	139
ATENÇÃO	
5.20	
V 36 00.33.47	
T40	140
5.47	
V 36	
T40	141
5.68	
V 33 00.34.35	
T41	142
5.86	
V 33	
T41	143
5.90	
N 1' 00.34.59	
T42	144

5.90	
V 27 00.35.59	
T43	145
6.13	
0.00	
V 30 00.36.30	
T44	146
0.15	
V 30	
T44	147
0.26	
V 36 00.37.01	
T45	148
0.36	
V 36	
T45	149
0.51	
V 36	
T45	150

0.60	
V 24 00.37.35	
T46	151

0.63	
V 24	
T46	152

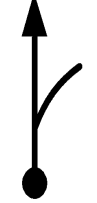
0.66	
V 36 00.37.44	
T47	153



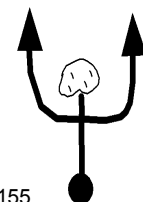

0.82	
V 36	
T47	154

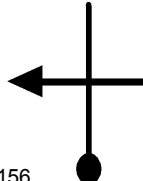
ESCOLHA!

0.93	
V 30 00.38.11	
T48	155

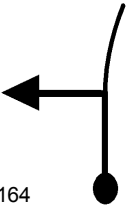
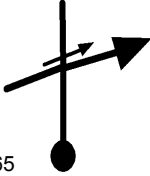
0.96	
V 36 00.38.15	
T49	156

1.25	
V 36	
T49	157
ATENÇÃO!!	
1.29	
V 36	
T49	158
ATENÇÃO!!	
1.48	
V 36	
T49	159
1.66	
V 36	
T49	160
1.89	
NI'30s 00.39.48	
T50	161
1.89	
V 30 00.41.18	
T51	162

2.00	
V 33 00.41.31	
T52	163
2.20	
V 33	
T52	164
ATENÇÃO	
2.35	
V 36 00.42.09	
 T53	165
2.43	
V 24 00.42.17	
T54	166
2.46	
V 24	
T54	167
2.50	
V 36 00.42.28	
T55	168

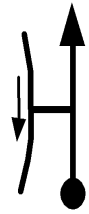
2.67	
V 36	
T55	169

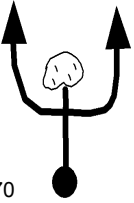
2.78	
V 30 00.42.56	
T56	170

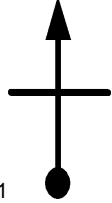
2.81	
V 33 00.42.59	
T57	171

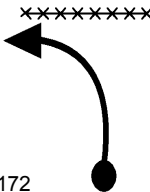
3.04	
V 33	
T57	172

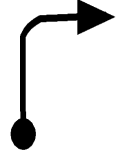
3.15	
V 33	
T57	173

COSTEAR CERCA

3.20	
V 36 00.43.42	
T58	174

COSTEAR MATO

3.25

V 36

T58 175



3.43

V 30 00.44.05

T59 176



3.50

V 30

T59 177

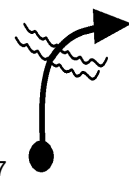

ACELERE!!

3.64

V 30

T59 178

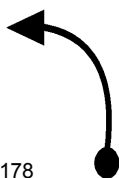

BAMP

3.72

V 27 00.44.40

T60 179



3.84

N 2' 00.44.56

T61 180



NÃO ERRE

3.84

V 36 00.46.56

T62

181



4.03

V 36

T62

182



4.16

V 24 00.47.28

T63

183



NAO ERRE!

POSTE TBG

4.27

V 33 00.47.44



T64

184



4.50

V 33

T64

185

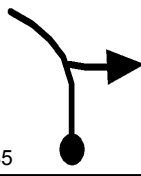

4.54

V 33

T64

186

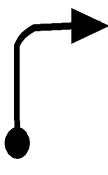

ENTRE NO

CALIPAL

4.57

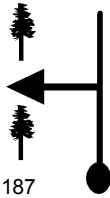

V 33

T64

187

4.77

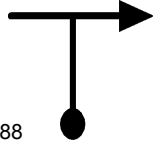

V 30 00.48.39

T65

188

4.80



V 30

T65

189

4.83

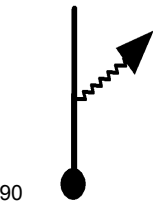

V 33 00.48.46

T66

190

4.99



V 33

T66

191

5.09

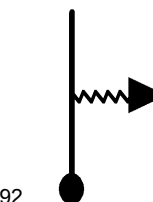

V 30 00.49.14

T67

192

ATOLEIRO!

5.64

V 30

T67 193



5.79

N 1' 00.50.38

T68 194



5.79

0.00

V 30 00.51.38

T69 195

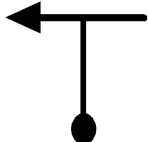

0.23

V 30

T69 196



0.32

V 30

T69 197

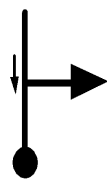

0.64

V 33 00.52.55

T70 198



CUIDADO ESTRADA!

0.79

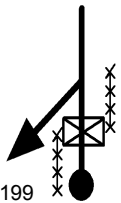

V 36 00.53.11



T71

199

1.29

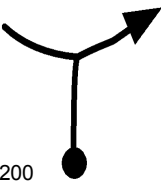

V 36

T71

200

2.00

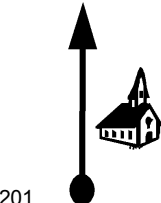

V 36

T71

201

2.15

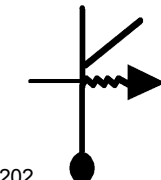

V 42 00.55.27

T72

202

2.46

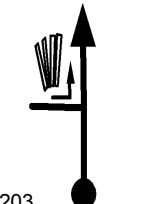

V 42

T72

203

COSTEAR CALIPO

2.56

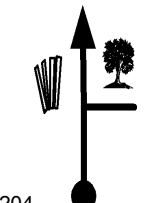

V 42

T72

204

COSTEAR ROÇA

2.69



V 33 00.56.14

T73 205

COSTEAR ROÇA

2.73

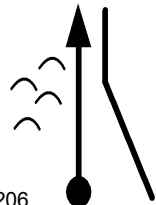

V 33

T73 206

2.75

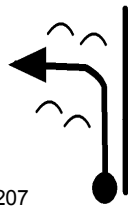

V 33

T73 207

2.95

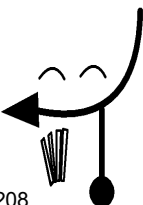

V 33

T73 208

3.02

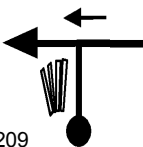

V 42 00.56.50

T74 209

COSTEAR CALIPO

3.10



V 42

T74 210

COSTEAR ROÇA

3.23



V 33 00.57.08

T75 211

COSTEAR ROÇA

3.26

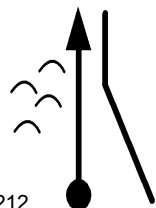

V 33

T75 212

3.29

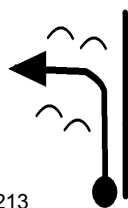

V 33

T75 213

3.45

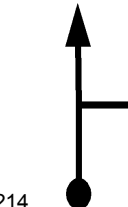

V 33

T75 214

3.48

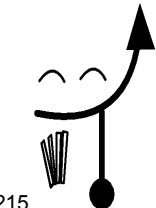

V 30 00.57.35

T76 215

COSTEAR MATO

3.50



V 30

T76 216

COSTEAR MATO

NA DIREITA!

3.57

V 30

T76 217

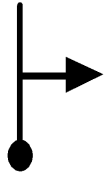

3.68

N 2' 00.57.59

T77 218



3.68

V 30 00.59.59

T78 219

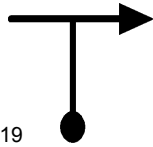

3.72

V 30

T78 220



4.09

V 33 01.00.48

T79 221



4.12

V 33

T79 222



4.14

V 33

T79 223

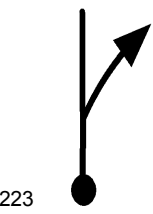

4.26

V 33

T79 224

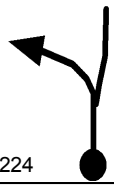

4.33

V 33

T79 225

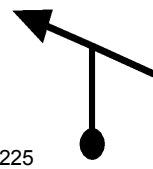

4.35

V 33

T79 226

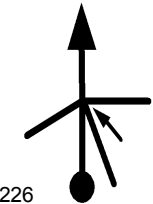

4.38

V 33

T79 227

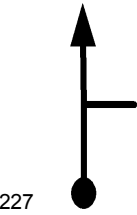



4.41

V 33

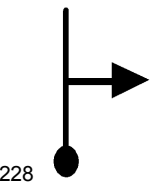
T79 228

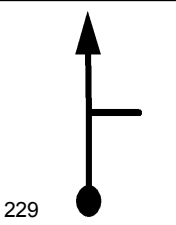
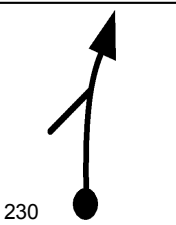
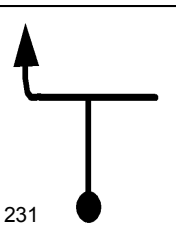
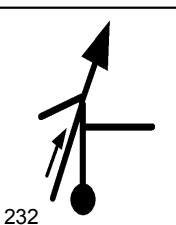
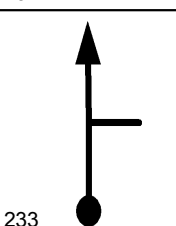
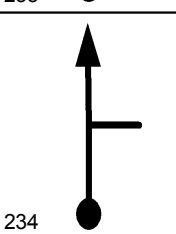

4.49	
V 33	
T79	229
4.51	
V 33	
T79	230
4.59	
V 33	
T79	231
4.88	
V 33	
T79	232
4.91	
V 33	
T79	233
4.94	
V 33	
T79	234

5.01	
NI'30s 01.02.28	
T80	235

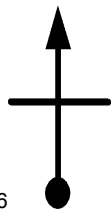
5.01	
V 33 01.03.58	
T81	236

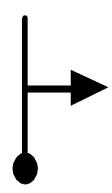
5.04	
V 33	
T81	237

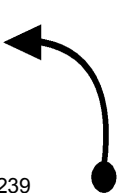

5.09	
V 33	
T81	238

5.18	
V 33	
T81	239

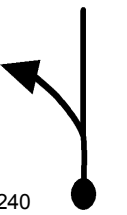

5.23	
V 33	
T81	240

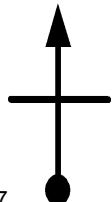
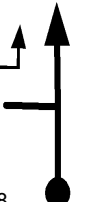
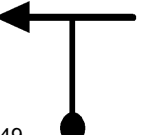
5.33	
V 33	
T81	241
5.40	
V 33	
T81	242
5.54	
V 33	
T81	243
ATENCAO ABISMO	
5.58	
V 33	
T81	244
5.73	
V 30 01.05.17	
T82	245
5.75	
V 33 01.05.19	
T83	246

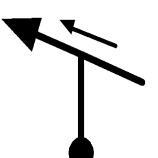
5.83	
V 33	
T83	247
5.88	
V 33	
T83	248
5.94	
V 33	
T83	249
1	
6.01	
V 33	
T83	250
6.04	
V 33	
T83	251
6.09	
V 33	
T83	252

6.14	
V 33	
T83 253	
ENTRE NO MATO	
6.25	
V 30 01.06.14	
T84 254	
6.41	
V 30	
T84 255	
COSTEAR MATO	
6.51	
V 30	
T84 256	
COSTEAR CERCA	
DESCIDA	
6.75	
V 36 01.07.14	
T85 257	

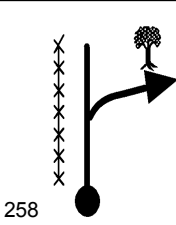
6.94	
V 39 01.07.33	
T86	258

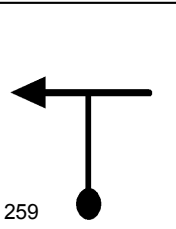
7.00	
V 39	
T86	259

7.10	
NI'30s 01.07.48	
T87	260

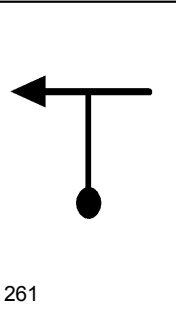
7.10	
0.00	
V 36 01.09.18	
T88	261

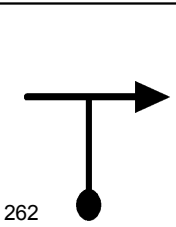
0.70	
V 36	
T88	262

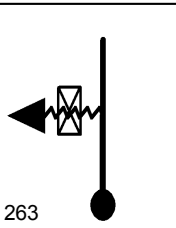
1.24	
V 36 01.11.22	
T89	263

1.32	
V 36	
T89	264
COSTEAR CERCA	
1.36	*****
V 36	
T89	265
Bamp	
1.57	
V 36	
T89	266
1.67	
V 33 01.12.05	
T90	267
PONTE PERIGOSA	
2.10	
V 33	
☠☠☠ T90	268
2.21	
V 15 01.13.04	
T91	269

2.22	
V 15	
T91	

270

2.26	
N 18' 01.13.16	
T92	

271

2.26	
0.00	
V 36 01.31.16	
T93	

272

0.24	
V 36	
T93	

273

0.35	
V 36	
T93	

274

0.38	
V 36	
T93	

275

INICIO ASFALTO

1.88	
V 36	
T93	276

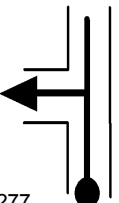
1.98	
V 36	
T93	277

2.31	
V 36	
T93	278

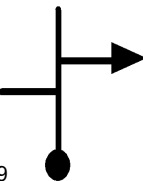
2.60	
V 30 01.35.36	
T94	279

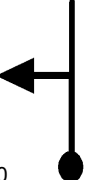
2.73	
V 30	
T94	280

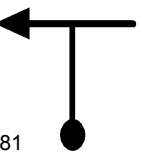
2.88	
V 30	
T94	281

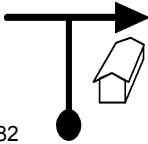
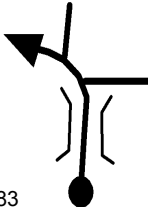
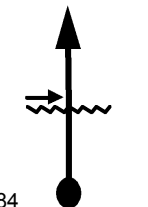
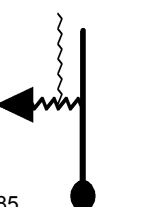
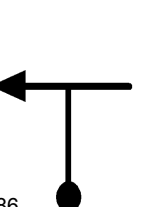
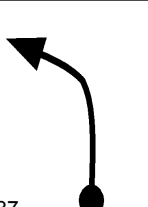
2.99	
V 36 01.36.22	
T95	282
3.35	
V 36	
T95	283
3.57	
V 36	
T95	284
3.84	
V 42 01.37.47	
T96	285
4.33	
V 42	
T96	286
4.46	
V 33 01.38.41	
T97	287

ATENÇÃO

4.72



V 33



T97

288

4.80

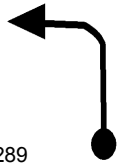

V 33

T97

289

4.93



N 1' 01.39.32

T98

290

4.93

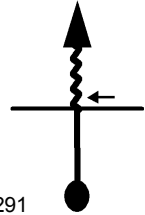

V 33 01.40.32

T99

291

5.23



V 33

T99

292

5.45

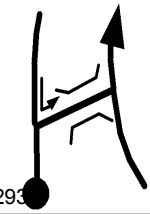

V 33

T99

293

5.60	
V 33	
T99	294
5.69	
V 33	
T99	295
5.72	
V 33	
T99	296
5.80	
V 30 01.42.07	
T100	297
6.06	
V 30 01.42.38	
T101	298
6.23	
0.00	
V 30 01.42.58	
T102	299



0.36	
V 30 01.43.42	
T103	300

0.53	
V 30	
T103	301

0.64	
N 1' 01.44.15	
T104	302

NÃO ERRE

0.64	
V 33 01.45.15	
T105	303

0.78	
V 33	
T105	304

0.87

V 30 01.45.40

T106 305



1.08

V 30

T106 306



1.17

V 30

T106 307



1.52

V 30

T106 308



1.60

V 30

T106 309



PELO TRILHO





DO GADO





1.69

V 30

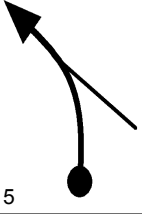
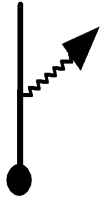
T106 310

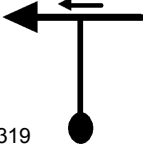

1.79	
N 2' 01.47.31	
T107	311
1.79	
V 33 01.49.31	
T108	312
1.81	
V 33	
T108	313
1.94	
V 33	
T108	314
2.03	
V 33	
T108	315
2.06	
V 30 01.50.00	
T109	316

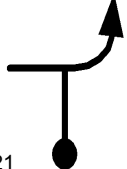
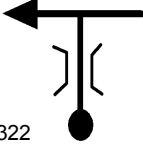
2.44	
V 30	
T109	317
2.45	
V 30	
T109	318
2.76	
V 33 01.51.24	
T110	319
2.80	
V 33	
T110	320
2.90	
V 30 01.51.39	
T111	321
3.09	
V 30	
T111	322

BAMP

3.14

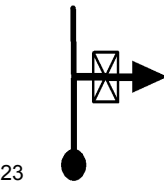

V 42 01.52.08

T112 323

COSTEAR CERCA

3.32

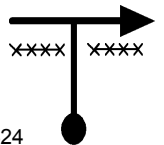

V 36 01.52.24

T113 324

COSTEAR MATO

3.44

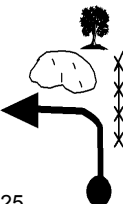

V 36

T113 325

COSTEAR MATO

3.58

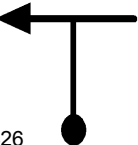

V 36

T113 326

COSTEAR MATO

3.80

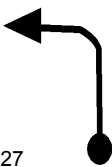

V 36

T113 327

COSTEAR CERCA

3.89

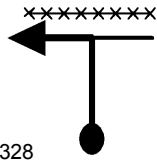

V 36

T113 328

3.97

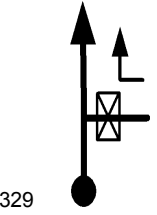

V 36

T113 329

COSTEAR MATO

4.09

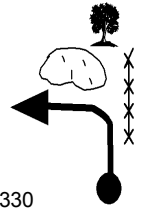

V 36

T113 330

4.23

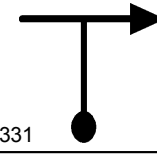

V 27 01.53.55

T114 331

4.27



N 2' 01.54.00

T115 332

4.27

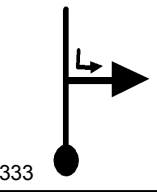

V 30 01.56.00

T116 333

4.55



N 30s 01.56.34

T117 334

ATENÇÃO

4.55

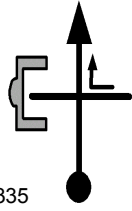

V 30 01.57.04

T118 335

4.59

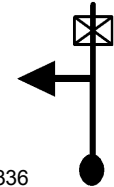

V 33 01.57.08

T119 336

5.06

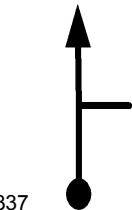

V 36 01.58.00

T120 337

COSTEAR BANANEIRA

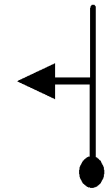

5.24



0.00

V 36 01.58.18

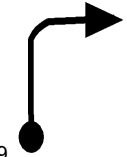
T121 338

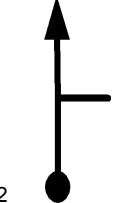
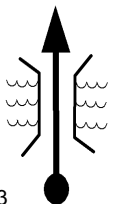
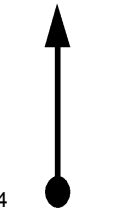
0.36	
V 36	
T121	339
0.40	
V 30 01.58.58	
T122	340
0.52	
V 30	
T122	341
0.70	
V 27 01.59.34	
T123	342
0.74	
V 30 01.59.39	
T124	343
COSTEAR MATO	
0.96	
V 30	
T124	344

NÃO ERRE

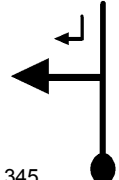
1.07	
V 30 02.00.19	
T125	345

1.34	
NI'30s 02.00.51	
T126	346

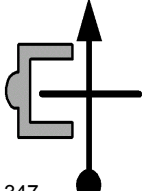
1.34	
V 30 02.02.21	
T127	347

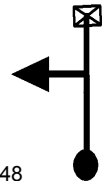
1.37	
V 33 02.02.25	
T128	348

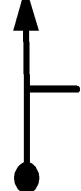
1.86	
V 36 02.03.18	
T129	349

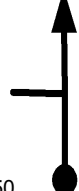
2.04	
V 36	
T129	350

ENTRE NO MATO

2.10	
V 36	
T129 351	

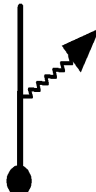
2.12	
V 27 02.03.44	
T130 352	

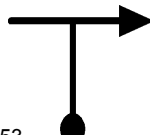
2.44	
V 30 02.04.27	
T131 353	



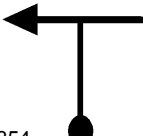

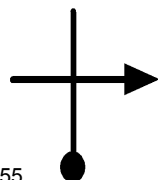
COSTEAR MATO

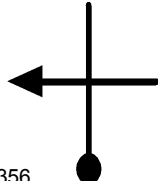
2.69	
V 33 02.04.57	
T132 354	

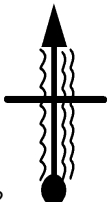

2.78	
V 33	
T132 355	

2.90	
V 33	
T132 356	

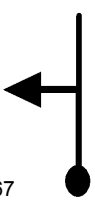
2.94	
V 33	
T132	357
CUIDADO DESCIDA	
3.13	
V 27 02.05.45	
T133	358
SE PREPARA !!	
3.39	
V 12 02.06.19	
T134	359
3.42	
V 12	
T134	360
3.44	
V 12	
T134	361

3.52	
V 12	
T134	³⁶²
ARVORE	
POR BAIXO	
3.61	
V 12	
T134	³⁶³
3.63	
V 33 02.07.31	
T135	³⁶⁴
3.85	
V 12 02.07.55	
T136	³⁶⁵
3.94	
N 4' 02.08.22	
T137	³⁶⁶
3.94	
V 33 02.12.22	
T138	³⁶⁷

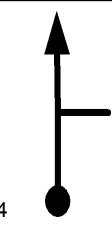
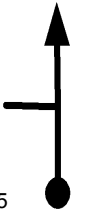
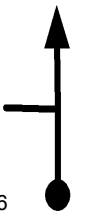
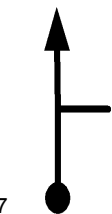
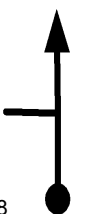
4.00	
V 33	
T138	368
4.04	
V 33	
T138	369
4.14	
V 30 02.12.44	
T139	370
4.33	
V 30	
T139	371
4.42	
V 30	
T139	372
4.46	
V 33 02.13.22	
T140	373

4.94	
V 36 02.14.15	
T141	374
5.12	
V 36	
T141	375
5.17	
V 36	
T141	376
5.19	
V 33 02.14.40	
T142	377
5.31	
V 33	
T142	378
5.42	
V 33	
T142	379

COSTEAR MATO

<h1>5.53</h1>	
V 33	
T142 380	

<h1>5.68</h1>	
V 33	
T142 381	

<h1>5.77</h1>	
V 33 02.15.43	
T143 382	

<h1>5.80</h1>	
V 42 02.15.46	
T144 383	

<h1>5.95</h1>	
V 42	
T144 384	

<h1>6.00</h1>	
V 30 02.16.04	
T145 385	

6.34	
NI'30s 02.16.44	
T146 386	

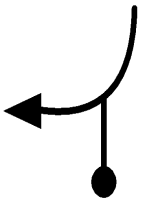
6.34	
0.00	
V 30 02.18.14	
T147 387	

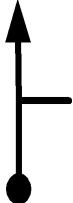
0.72	
V 30	
T147 388	

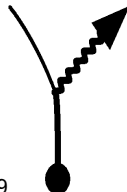
0.78	
V 33 02.19.48	
T148 389	

COSTEAR CALIPO

0.84	
V 33	
T148 390	

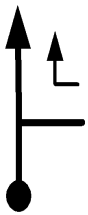
1.04	
V 33	
T148 391	

1.09	
V 33	
T148	392
1.15	
V 33	
T148	393
COSTEAR MATO	
1.23	
V 33	
T148	394
1.33	
V 33	
T148	395
COSTEAR MATO	
1.38	
V 33	
T148	396
1.47	
V 33	
T148	397

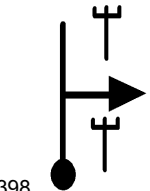
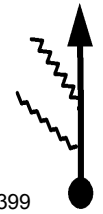
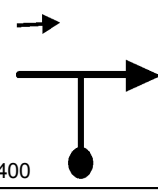
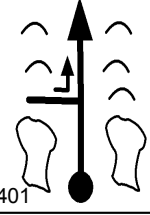
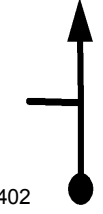
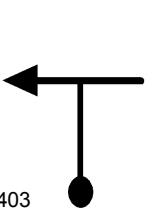
1.57	
V 33	
T148	398
COSTEAR BANANEIRA	
1.63	
V 33	
T148	399
1.70	
V 33	
T148	400
1.73	
V 33	
T148	401
1.81	
V 33	
T148	402
1.89	
V 33	
T148	403

BAMP

1.90

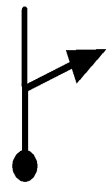

V 30 02.21.50

T149 404

1.96

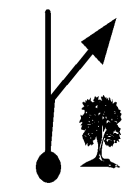

V 30

T149 405

BAMP

2.00



V 30

T149 406

ENTRE NO MATO

2.13



V 33 02.22.18

T150 407

2.39

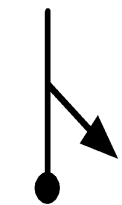

V 33

T150 408

2.64



V 24 02.23.13

T151 409

2.67	
V 33 02.23.18	
T152	410
2.79	
N 1' 02.23.31	
T153	411
COSTEAR MATO	
2.79	
V 33 02.24.31	
T154	412
2.84	
V 33	
T154	413
2.93	
V 33	
T154	414
3.03	
V 33	
T154	415

3.09	
V 33	
T154	416

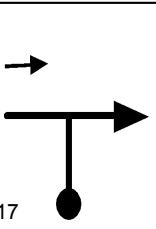
3.16	
V 33	
T154	417

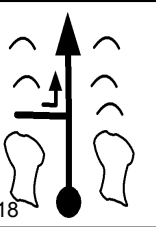
3.20	
V 33	
T154	418

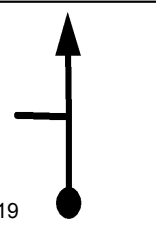
3.27	
V 33	
T154	419

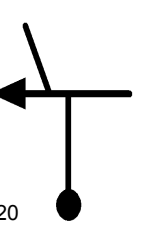

COSTEAR PARREIRA DE UVA

3.35	
V 33	
T154	420

CEPOS

3.42

V 33

T154⁴²¹



COSTEAR MATO

3.48

V 30 02.25.46

T155⁴²²



COSTEAR MATO

3.59

V 30

T155⁴²³

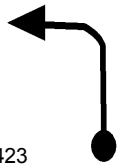

COSTEAR MATO

3.62

V 30

T155⁴²⁴









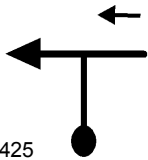

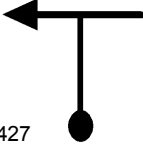

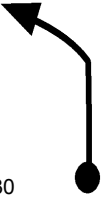
3.73

V 33 02.26.16

T156⁴²⁵

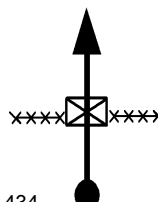

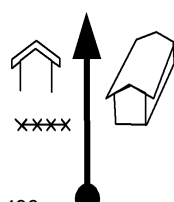
3.79	
V 33	
T156	426
3.87	
V 33	
T156	427
BAMP	
3.88	
V 30 02.26.33	
T157	428
BAMP	
3.94	
V 30	
T157	429
3.99	
V 30	
T157	430
ENTRE NO MATO	
4.12	
V 33 02.27.01	
T158	431

4.38	
V 24 02.27.30	
T159	432
4.59	
V 24	
T159	433
4.70	
V 21 02.28.18	
T160	434
4.73	
N 1' 02.28.23	
T161	435
4.73	
V 21 02.29.23	
T162	436
4.77	
V 21	
T162	437

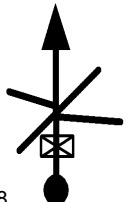
4.86	
V 33 02.29.45	
T163	438

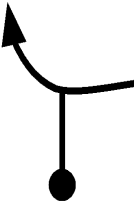
5.80	
0.00	
V 33 02.31.28	
T164	439

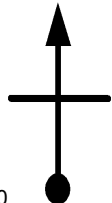
0.53	
V 33	
T164	440

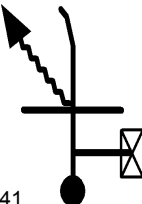
1.64	
V 33 02.34.27	
T165	441

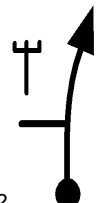

COSTEAR MATO

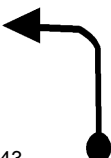

2.14	
V 33	
T165	442

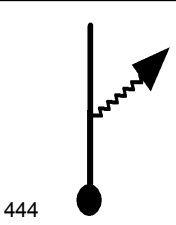
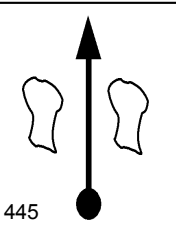
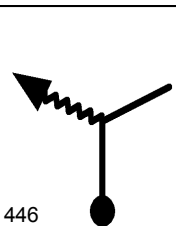
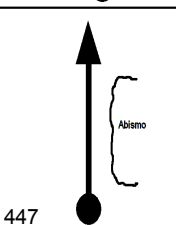
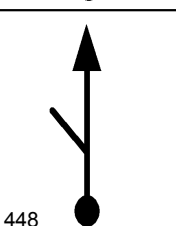
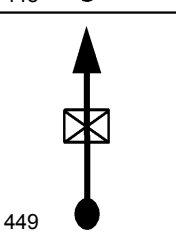
COSTEAR MATO

2.67	
V 33	
T165	443

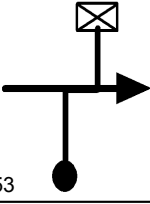
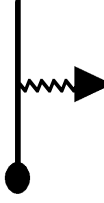
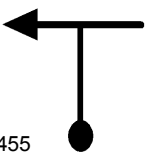

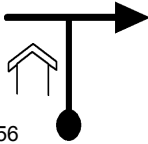
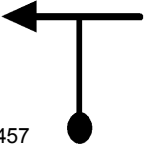
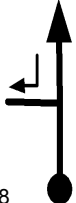
2.77	
V 33	
T165	444
3.00	
V 33	
T165	445
3.07	
V 33	
T165	446
3.25	
V 33	
T165	447
3.70	
V 33	
T165	448
3.73	
V 27 02.38.15	
T166	449

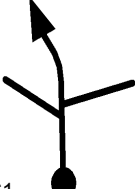
3.78	
N 1' 02.38.21	
T167	450
3.78	
V 27 02.39.21	
T168	451
MATA BURRO	
3.83	
V 33 02.39.28	
T169	452
4.06	
V 30 02.39.53	
T170	453
4.30	
V 30 02.40.22	
T171	454
4.47	
V 30	
T171	455

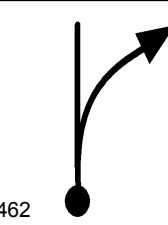
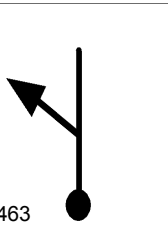
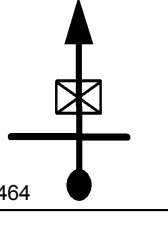
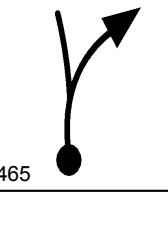
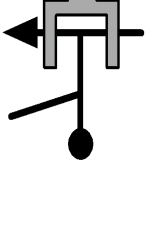
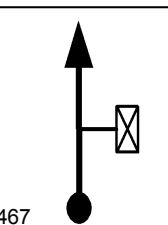
4.50	
V 30 02.40.46	
T172	456
4.64	
V 30	
T172	457
4.74	
V 30	
T172	458
4.83	
V 39 02.41.25	
T173	459
5.03	
V 39	
T173	460
5.69	
V 39	
T173	461

5.83	
V 39	
T173 462	
ENTRE NO CALIPAL	
5.89	
V 36 02.43.03	
T174 463	
5.91	
V 36	
T174 464	
6.17	
V 36	
T174 465	
6.39	
0.00	
V 33 02.43.53	
T175 466	
0.08	
V 33	
T175 467	

0.65	
V 33	
T175	468
0.70	
V 33 02.45.10	
T176	469
0.93	
V 33	
T176	470
0.99	
V 33	
T176	471
1.09	
V 33	
T176	472
1.21	
V 33	
T176	473

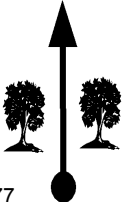
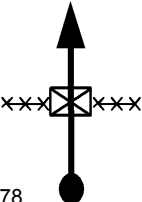
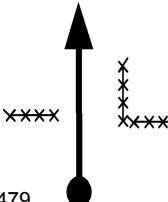
1.34	
V 33	
T176 ⁴⁷⁴	
BAMP	
1.47	
V 33	
T176 ⁴⁷⁵	
1.53	
V 33	
T176 ⁴⁷⁶	
1.57	
V 33	
T176 ⁴⁷⁷	
1.72	
V 33	
T176 ⁴⁷⁸	
COSTEAR CERCA	
1.87	
V 33	
T176 ⁴⁷⁹	



COSTEAR CERCA

1.95	
V 33	
T176 480	

2.02	
V 33	
T176 481	

BAMP

2.08	
V 33	
T176 482	

2.20	
V 30 02.47.53	
T177 483	

2.35	
V 30	
T177 484	

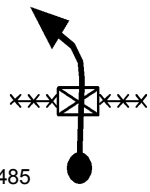
2.39	
V 30	
T177	485

BAMP

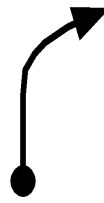
2.44	
V 36 02.48.22	
T178	486

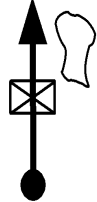
2.71	
V 36	
T178	487

BAMP

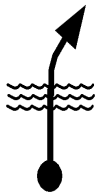

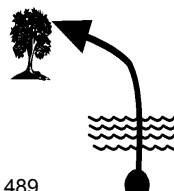

2.78	
V 24 02.48.56	
T179	488

TRILHO DO GADO

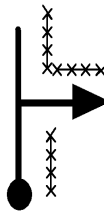
2.82	
V 27 02.49.02	
T180	489

COSTEAR CERCA

2.89	
V 36 02.49.11	
T181	490

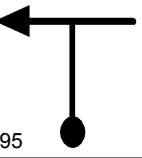
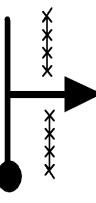
3.25	
V 33 02.49.47	
T182	491
3.42	
N 2' 02.50.06	
T183	492
3.42	
V 18 02.52.06	
T184	493
3.49	
V 18	
T184	494
3.58	
V 30 02.52.38	
T185	495
BAMP	
3.61	
V 33 02.52.41	
T186	496

3.71	
V 33	
T186	497
COSTEAR CERCA	
3.74	*****
V 33	
T186	498
BAMP	
3.95	
V 33	
T186	499
4.06	
V 30 02.53.31	
T187	500
PONTE PERIGOSA	
4.48	
V 30	
T187	501
4.58	
V 15 02.54.33	
T188	502

4.60

V 15

T188

503

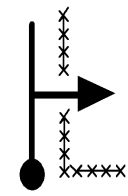

4.64

V 15 02.54.47

T188

504



FIM DE PROVA !!



www.t15.com.br

Tempo de Prova

MÉDIA B 02:54:47

FIM